

2N5400, 2N5401

Preferred Device

Amplifier Transistors

PNP Silicon

Features

- Pb-Free Packages are Available*

MAXIMUM RATINGS

Rating	Symbol	2N5400	2N5401	Unit
Collector – Emitter Voltage	V_{CEO}	120	150	Vdc
Collector – Base Voltage	V_{CBO}	130	160	Vdc
Emitter – Base Voltage	V_{EBO}	5.0		Vdc
Collector Current – Continuous	I_C	600		mAdc
Total Device Dissipation @ $T_A = 25^\circ\text{C}$ Derate above 25°C	P_D	625	5.0	mW mW/ $^\circ\text{C}$
Total Device Dissipation @ $T_C = 25^\circ\text{C}$ Derate above 25°C	P_D	1.5	12	Watts mW/ $^\circ\text{C}$
Operating and Storage Junction Temperature Range	T_J, T_{stg}	–55 to +150		$^\circ\text{C}$

Maximum ratings are those values beyond which device damage can occur. Maximum ratings applied to the device are individual stress limit values (not normal operating conditions) and are not valid simultaneously. If these limits are exceeded, device functional operation is not implied, damage may occur and reliability may be affected.

THERMAL CHARACTERISTICS

Characteristic	Symbol	Max	Unit
Thermal Resistance, Junction–to–Ambient	$R_{\theta JA}$	200	$^\circ\text{C}/\text{W}$
Thermal Resistance, Junction–to–Case	$R_{\theta JC}$	83.3	$^\circ\text{C}/\text{W}$



ON Semiconductor®

<http://onsemi.com>

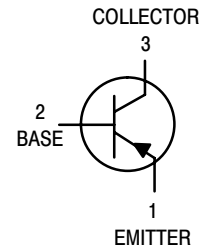

MARKING DIAGRAM

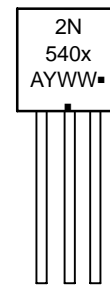

- A = Assembly Location
 - Y = Year
 - WW = Work Week
 - = Pb-Free Package
- (Note: Microdot may be in either location)

ORDERING INFORMATION

See detailed ordering and shipping information in the package dimensions section on page 5 of this data sheet.

*For additional information on our Pb-Free strategy and soldering details, please download the ON Semiconductor Soldering and Mounting Techniques Reference Manual, SOLDERRM/D.

Preferred devices are recommended choices for future use and best overall value.

2N5400, 2N5401

ELECTRICAL CHARACTERISTICS ($T_A = 25^\circ\text{C}$ unless otherwise noted)

Characteristic	Symbol	Min	Max	Unit
OFF CHARACTERISTICS				
Collector–Emitter Breakdown Voltage ⁽¹⁾ ($I_C = 1.0\text{ mA}$, $I_B = 0$)	2N5400 2N5401	$V_{(BR)CEO}$ 120 150	– –	Vdc
Collector–Base Breakdown Voltage ($I_C = 100\text{ }\mu\text{A}$, $I_E = 0$)	2N5400 2N5401	$V_{(BR)CBO}$ 130 160	– –	Vdc
Emitter–Base Breakdown Voltage ($I_E = 10\text{ }\mu\text{A}$, $I_C = 0$)		$V_{(BR)EBO}$ 5.0	–	Vdc
Collector Cutoff Current ($V_{CB} = 100\text{ Vdc}$, $I_E = 0$) ($V_{CB} = 120\text{ Vdc}$, $I_E = 0$) ($V_{CB} = 100\text{ Vdc}$, $I_E = 0$, $T_A = 100^\circ\text{C}$) ($V_{CB} = 120\text{ Vdc}$, $I_E = 0$, $T_A = 100^\circ\text{C}$)	2N5400 2N5401 2N5400 2N5401	I_{CBO} – – – –	100 50 100 50	nAdc μAdc
Emitter Cutoff Current ($V_{EB} = 3.0\text{ Vdc}$, $I_C = 0$)		I_{EBO} –	50	nAdc
ON CHARACTERISTICS (Note 1)				
DC Current Gain ($I_C = 1.0\text{ mA}$, $V_{CE} = 5.0\text{ Vdc}$) ($I_C = 10\text{ mA}$, $V_{CE} = 5.0\text{ Vdc}$) ($I_C = 50\text{ mA}$, $V_{CE} = 5.0\text{ Vdc}$)	2N5400 2N5401 2N5400 2N5401 2N5400 2N5401	h_{FE} 30 50 40 60 40 50	– – 180 240 – –	–
Collector–Emitter Saturation Voltage ($I_C = 10\text{ mA}$, $I_B = 1.0\text{ mA}$) ($I_C = 50\text{ mA}$, $I_B = 5.0\text{ mA}$)		$V_{CE(sat)}$ – –	0.2 0.5	Vdc
Base–Emitter Saturation Voltage ($I_C = 10\text{ mA}$, $I_B = 1.0\text{ mA}$) ($I_C = 50\text{ mA}$, $I_B = 5.0\text{ mA}$)		$V_{BE(sat)}$ – –	1.0 1.0	Vdc
SMALL–SIGNAL CHARACTERISTICS				
Current–Gain — Bandwidth Product ($I_C = 10\text{ mA}$, $V_{CE} = 10\text{ Vdc}$, $f = 100\text{ MHz}$)	2N5400 2N5401	f_T 100 100	400 300	MHz
Output Capacitance ($V_{CB} = 10\text{ Vdc}$, $I_E = 0$, $f = 1.0\text{ MHz}$)		C_{obo} –	6.0	pF
Small–Signal Current Gain ($I_C = 1.0\text{ mA}$, $V_{CE} = 10\text{ Vdc}$, $f = 1.0\text{ kHz}$)	2N5400 2N5401	h_{fe} 30 40	200 200	–
Noise Figure ($I_C = 250\text{ }\mu\text{A}$, $V_{CE} = 5.0\text{ Vdc}$, $R_S = 1.0\text{ k}\Omega$, $f = 1.0\text{ kHz}$)		NF –	8.0	dB

1. Pulse Test: Pulse Width $\leq 300\text{ }\mu\text{s}$, Duty Cycle $\leq 2.0\%$.

2N5400, 2N5401

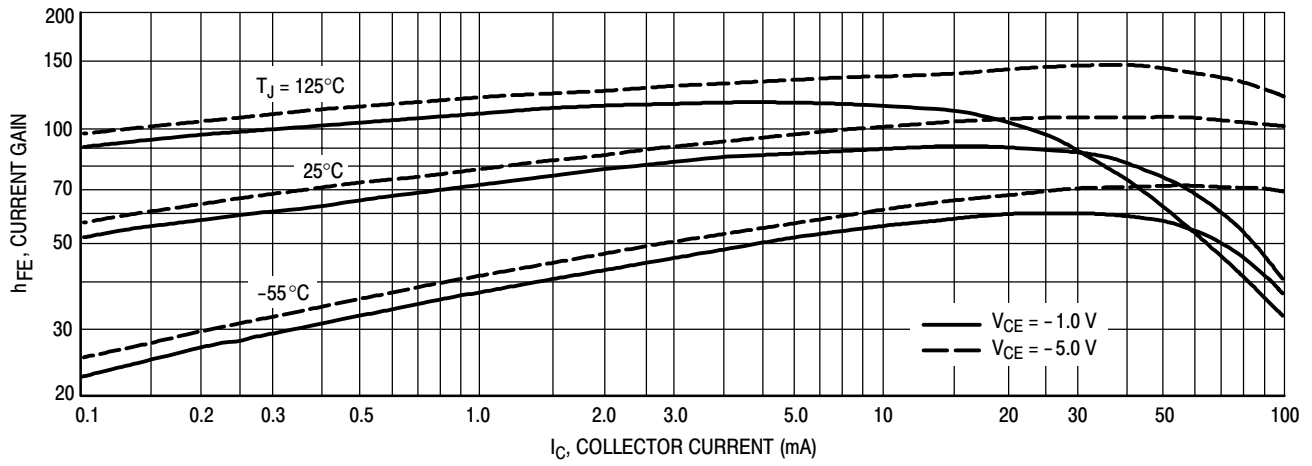

Figure 1. DC Current Gain

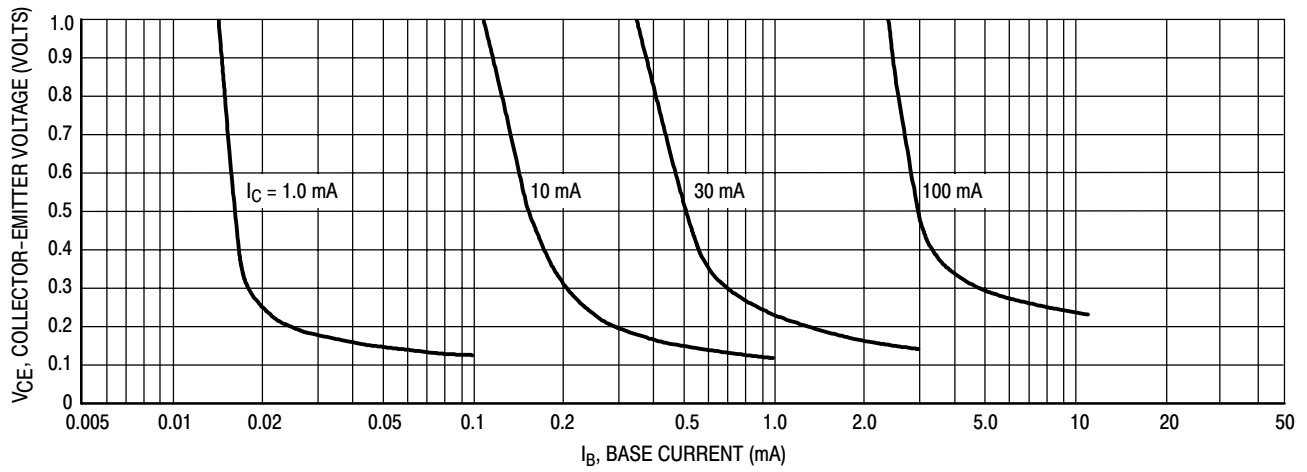

Figure 2. Collector Saturation Region

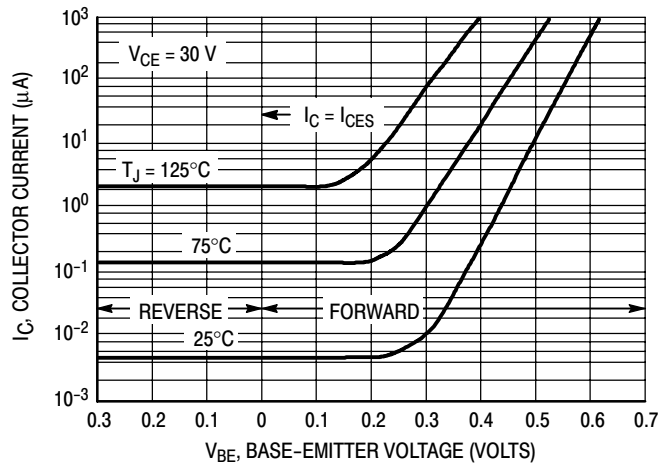

Figure 3. Collector Cut-Off Region

2N5400, 2N5401

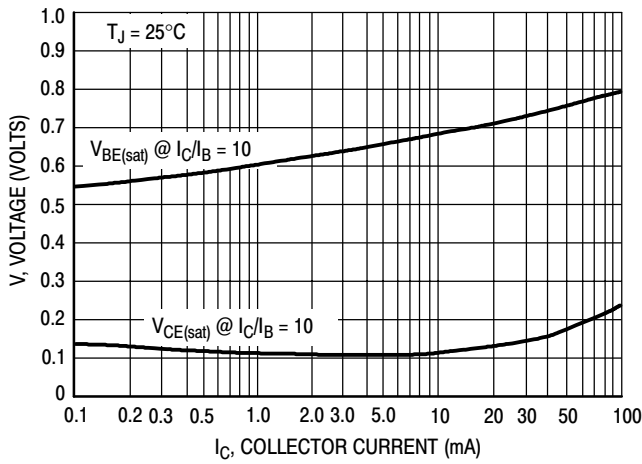

Figure 4. "On" Voltages

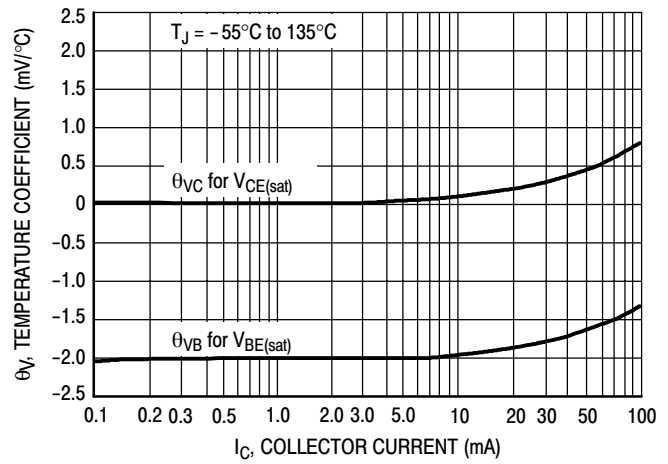

Figure 5. Temperature Coefficients

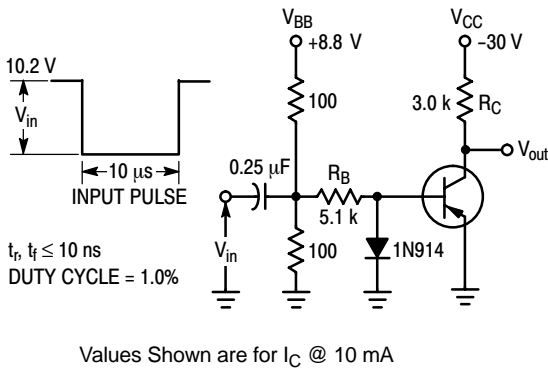

Figure 6. Switching Time Test Circuit

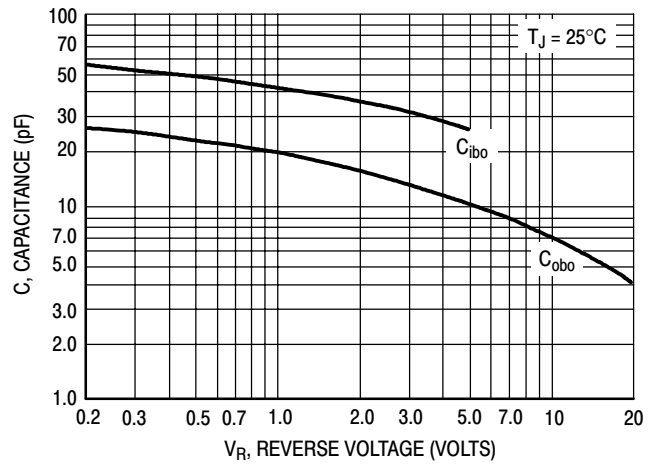

Figure 7. Capacitances

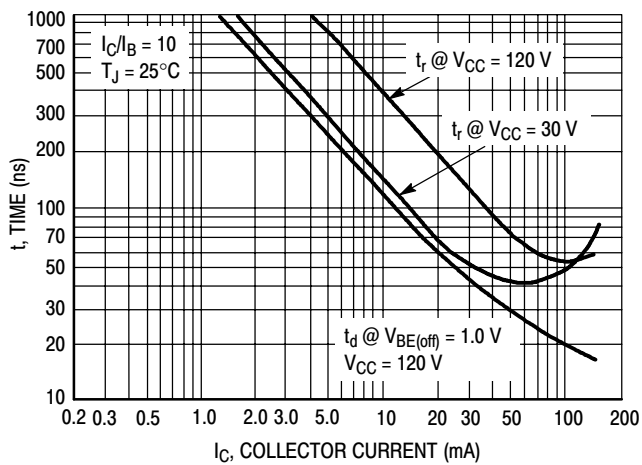

Figure 8. Turn-On Time

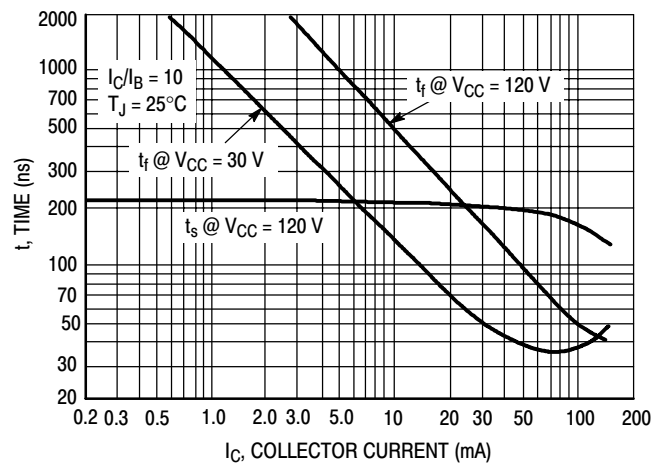

Figure 9. Turn-Off Time

2N5400, 2N5401

ORDERING INFORMATION

Device	Package	Shipping†
2N5400	TO-92	5000 Unit / Bulk
2N5400G	TO-92 (Pb-Free)	5000 Unit / Bulk
2N5400RLRP	TO-92	2000 Tape & Reel
2N5400RLRPG	TO-92 (Pb-Free)	2000 Tape & Reel
2N5401	TO-92	5000 Unit / Bulk
2N5401G	TO-92 (Pb-Free)	5000 Unit / Bulk
2N5401RL1	TO-92	2000 Tape & Reel
2N5401RL1G	TO-92 (Pb-Free)	2000 Tape & Reel
2N5401RLRA	TO-92	2000 Tape & Reel
2N5401RLRAG	TO-92 (Pb-Free)	2000 Tape & Reel
2N5401RLRM	TO-92	2000 Tape & Ammo Box
2N5401RLRMG	TO-92 (Pb-Free)	2000 Tape & Ammo Box
2N5401ZL1	TO-92	2000 Tape & Ammo Box
2N5401ZL1G	TO-92 (Pb-Free)	2000 Tape & Ammo Box

†For information on tape and reel specifications, including part orientation and tape sizes, please refer to our Tape and Reel Packaging Specifications Brochure, BRD8011/D.

2N5400, 2N5401

PACKAGE DIMENSIONS

TO-92
CASE 29-11
ISSUE AL

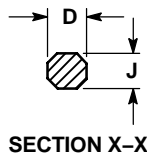
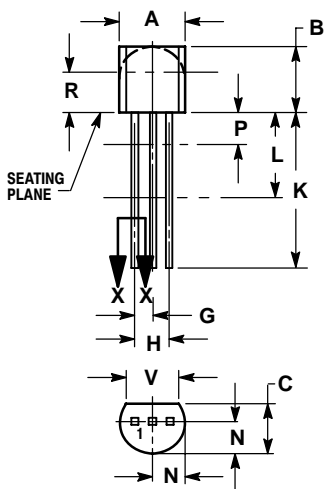

NOTES:

1. DIMENSIONING AND TOLERANCING PER ANSI Y14.5M, 1982.
2. CONTROLLING DIMENSION: INCH.
3. CONTOUR OF PACKAGE BEYOND DIMENSION R IS UNCONTROLLED.
4. LEAD DIMENSION IS UNCONTROLLED IN P AND BEYOND DIMENSION K MINIMUM.

DIM	INCHES		MILLIMETERS	
	MIN	MAX	MIN	MAX
A	0.175	0.205	4.45	5.20
B	0.170	0.210	4.32	5.33
C	0.125	0.165	3.18	4.19
D	0.016	0.021	0.407	0.533
G	0.045	0.055	1.15	1.39
H	0.095	0.105	2.42	2.66
J	0.015	0.020	0.39	0.50
K	0.500	---	12.70	---
L	0.250	---	6.35	---
N	0.080	0.105	2.04	2.66
P	---	0.100	---	2.54
R	0.115	---	2.93	---
V	0.135	---	3.43	---

STYLE 1:

1. EMITTER
2. BASE
3. COLLECTOR

ON Semiconductor and are registered trademarks of Semiconductor Components Industries, LLC (SCILLC). SCILLC reserves the right to make changes without further notice to any products herein. SCILLC makes no warranty, representation or guarantee regarding the suitability of its products for any particular purpose, nor does SCILLC assume any liability arising out of the application or use of any product or circuit, and specifically disclaims any and all liability, including without limitation special, consequential or incidental damages. "Typical" parameters which may be provided in SCILLC data sheets and/or specifications can and do vary in different applications and actual performance may vary over time. All operating parameters, including "Typicals" must be validated for each customer application by customer's technical experts. SCILLC does not convey any license under its patent rights nor the rights of others. SCILLC products are not designed, intended, or authorized for use as components in systems intended for surgical implant into the body, or other applications intended to support or sustain life, or for any other application in which the failure of the SCILLC product could create a situation where personal injury or death may occur. Should Buyer purchase or use SCILLC products for any such unintended or unauthorized application, Buyer shall indemnify and hold SCILLC and its officers, employees, subsidiaries, affiliates, and distributors harmless against all claims, costs, damages, and expenses, and reasonable attorney fees arising out of, directly or indirectly, any claim of personal injury or death associated with such unintended or unauthorized use, even if such claim alleges that SCILLC was negligent regarding the design or manufacture of the part. SCILLC is an Equal Opportunity/Affirmative Action Employer. This literature is subject to all applicable copyright laws and is not for resale in any manner.

PUBLICATION ORDERING INFORMATION

LITERATURE FULFILLMENT:

Literature Distribution Center for ON Semiconductor
P.O. Box 61312, Phoenix, Arizona 85082-1312 USA
Phone: 480-829-7710 or 800-344-3860 Toll Free USA/Canada
Fax: 480-829-7709 or 800-344-3867 Toll Free USA/Canada
Email: orderlit@onsemi.com

N. American Technical Support: 800-282-9855 Toll Free
USA/Canada

Japan: ON Semiconductor, Japan Customer Focus Center
2-9-1 Kamimeguro, Meguro-ku, Tokyo, Japan 153-0051
Phone: 81-3-5773-3850

ON Semiconductor Website: <http://onsemi.com>

Order Literature: <http://www.onsemi.com/litorder>

For additional information, please contact your local Sales Representative.