

## 2N7000 / 2N7002 / NDS7002A N-Channel Enhancement Mode Field Effect Transistor

### General Description

These N-Channel enhancement mode field effect transistors are produced using Fairchild's proprietary, high cell density, DMOS technology. These products have been designed to minimize on-state resistance while provide rugged, reliable, and fast switching performance. They can be used in most applications requiring up to 400mA DC and can deliver pulsed currents up to 2A. These products are particularly suited for low voltage, low current applications such as small servo motor control, power MOSFET gate drivers, and other switching applications.

### Features

- High density cell design for low  $R_{DS(ON)}$ .
- Voltage controlled small signal switch.
- Rugged and reliable.
- High saturation current capability.

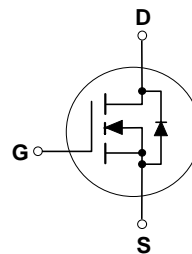
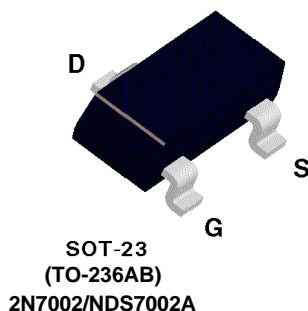
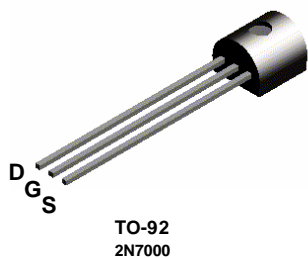

### Absolute Maximum Ratings $T_A = 25^\circ\text{C}$ unless otherwise noted

Symbol	Parameter	2N7000	2N7002	NDS7002A	Units
$V_{DSS}$	Drain-Source Voltage	60			V
$V_{DGR}$	Drain-Gate Voltage ( $R_{GS} \leq 1 \text{ M}\Omega$ )	60			V
$V_{GSS}$	Gate-Source Voltage - Continuous	$\pm 20$			V
	- Non Repetitive ( $t_p < 50\mu\text{s}$ )	$\pm 40$			
$I_D$	Maximum Drain Current - Continuous	200	115	280	mA
	- Pulsed	500	800	1500	
$P_D$	Maximum Power Dissipation	400	200	300	mW
	Derated above $25^\circ\text{C}$	3.2	1.6	2.4	mW/ $^\circ\text{C}$
$T_J, T_{STG}$	Operating and Storage Temperature Range	-55 to 150			$^\circ\text{C}$
$T_L$	Maximum Lead Temperature for Soldering Purposes, 1/16" from Case for 10 Seconds	300			$^\circ\text{C}$

### THERMAL CHARACTERISTICS

Symbol	Parameter	2N7000	2N7002	NDS7002A	Units
$R_{\theta JA}$	Thermal Resistance, Junction-to-Ambient	312.5	625	417	$^\circ\text{C}/\text{W}$

**Electrical Characteristics**  $T_A = 25^\circ\text{C}$  unless otherwise noted

Symbol	Parameter	Conditions	Type	Min	Typ	Max	Units
<b>OFF CHARACTERISTICS</b>							
$BV_{DSS}$	Drain-Source Breakdown Voltage	$V_{GS} = 0\text{ V}, I_D = 10\ \mu\text{A}$	All	60			V
$I_{DSS}$	Zero Gate Voltage Drain Current	$V_{DS} = 48\text{ V}, V_{GS} = 0\text{ V}$	2N7000			1	$\mu\text{A}$
		$T_J = 125^\circ\text{C}$				1	$\text{mA}$
		$V_{DS} = 60\text{ V}, V_{GS} = 0\text{ V}$	2N7002 NDS7002A			1	$\mu\text{A}$
		$T_J = 125^\circ\text{C}$				0.5	$\text{mA}$
$I_{GSSF}$	Gate - Body Leakage, Forward	$V_{GS} = 15\text{ V}, V_{DS} = 0\text{ V}$	2N7000			10	$\text{nA}$
		$V_{GS} = 20\text{ V}, V_{DS} = 0\text{ V}$	2N7002 NDS7002A			100	$\text{nA}$
$I_{GSSR}$	Gate - Body Leakage, Reverse	$V_{GS} = -15\text{ V}, V_{DS} = 0\text{ V}$	2N7000			-10	$\text{nA}$
		$V_{GS} = -20\text{ V}, V_{DS} = 0\text{ V}$	2N7002 NDS7002A			-100	$\text{nA}$
<b>ON CHARACTERISTICS</b> (Note 1)							
$V_{GS(th)}$	Gate Threshold Voltage	$V_{DS} = V_{GS}, I_D = 1\text{ mA}$	2N7000	0.8	2.1	3	V
		$V_{DS} = V_{GS}, I_D = 250\ \mu\text{A}$	2N7002 NDS7002A	1	2.1	2.5	
$R_{DS(on)}$	Static Drain-Source On-Resistance	$V_{GS} = 10\text{ V}, I_D = 500\text{ mA}$	2N7000		1.2	5	$\Omega$
		$T_J = 125^\circ\text{C}$			1.9	9	
		$V_{GS} = 4.5\text{ V}, I_D = 75\text{ mA}$	2N7002 NDS7002A		1.8	5.3	
		$V_{GS} = 10\text{ V}, I_D = 500\text{ mA}$			1.2	7.5	
		$T_J = 100^\circ\text{C}$			1.7	13.5	
		$V_{GS} = 5.0\text{ V}, I_D = 50\text{ mA}$			1.7	7.5	
		$T_J = 100^\circ\text{C}$			2.4	13.5	
		$V_{GS} = 10\text{ V}, I_D = 500\text{ mA}$		NDS7002A		1.2	
$T_J = 125^\circ\text{C}$		2	3.5				
$V_{GS} = 5.0\text{ V}, I_D = 50\text{ mA}$		1.7	3				
			2.8	5			
$V_{DS(on)}$	Drain-Source On-Voltage	$V_{GS} = 10\text{ V}, I_D = 500\text{ mA}$	2N7000		0.6	2.5	V
		$V_{GS} = 4.5\text{ V}, I_D = 75\text{ mA}$			0.14	0.4	
		$V_{GS} = 10\text{ V}, I_D = 500\text{ mA}$	2N7002		0.6	3.75	
		$V_{GS} = 5.0\text{ V}, I_D = 50\text{ mA}$			0.09	1.5	
		$V_{GS} = 10\text{ V}, I_D = 500\text{ mA}$	NDS7002A		0.6	1	
		$V_{GS} = 5.0\text{ V}, I_D = 50\text{ mA}$			0.09	0.15	

**Electrical Characteristics**  $T_A = 25^\circ\text{C}$  unless otherwise noted

Symbol	Parameter	Conditions	Type	Min	Typ	Max	Units
<b>ON CHARACTERISTICS</b> Continued (Note 1)							
$I_{D(ON)}$	On-State Drain Current	$V_{GS} = 4.5\text{ V}, V_{DS} = 10\text{ V}$	2N7000	75	600		mA
		$V_{GS} = 10\text{ V}, V_{DS} \geq 2 V_{DS(on)}$	2N7002	500	2700		
		$V_{GS} = 10\text{ V}, V_{DS} \geq 2 V_{DS(on)}$	NDS7002A	500	2700		
$g_{FS}$	Forward Transconductance	$V_{DS} = 10\text{ V}, I_D = 200\text{ mA}$	2N7000	100	320		mS
		$V_{DS} \geq 2 V_{DS(on)}, I_D = 200\text{ mA}$	2N7002	80	320		
		$V_{DS} \geq 2 V_{DS(on)}, I_D = 200\text{ mA}$	NDS7002A	80	320		
<b>DYNAMIC CHARACTERISTICS</b>							
$C_{iss}$	Input Capacitance	$V_{DS} = 25\text{ V}, V_{GS} = 0\text{ V},$ $f = 1.0\text{ MHz}$	All		20	50	pF
$C_{oss}$	Output Capacitance		All		11	25	pF
$C_{rss}$	Reverse Transfer Capacitance		All		4	5	pF
$t_{on}$	Turn-On Time	$V_{DD} = 15\text{ V}, R_L = 25\ \Omega,$ $I_D = 500\text{ mA}, V_{GS} = 10\text{ V},$ $R_{GEN} = 25$	2N7000			10	ns
		$V_{DD} = 30\text{ V}, R_L = 150\ \Omega,$ $I_D = 200\text{ mA}, V_{GS} = 10\text{ V},$ $R_{GEN} = 25\ \Omega$	2N700 NDS7002A			20	
$t_{off}$	Turn-Off Time	$V_{DD} = 15\text{ V}, R_L = 25\ \Omega,$ $I_D = 500\text{ mA}, V_{GS} = 10\text{ V},$ $R_{GEN} = 25$	2N7000			10	ns
		$V_{DD} = 30\text{ V}, R_L = 150\ \Omega,$ $I_D = 200\text{ mA}, V_{GS} = 10\text{ V},$ $R_{GEN} = 25\ \Omega$	2N700 NDS7002A			20	
<b>DRAIN-SOURCE DIODE CHARACTERISTICS AND MAXIMUM RATINGS</b>							
$I_S$	Maximum Continuous Drain-Source Diode Forward Current		2N7002			115	mA
			NDS7002A			280	
$I_{SM}$	Maximum Pulsed Drain-Source Diode Forward Current		2N7002			0.8	A
			NDS7002A			1.5	
$V_{SD}$	Drain-Source Diode Forward Voltage	$V_{GS} = 0\text{ V}, I_S = 115\text{ mA}$ (Note 1)	2N7002		0.88	1.5	V
		$V_{GS} = 0\text{ V}, I_S = 400\text{ mA}$ (Note 1)	NDS7002A		0.88	1.2	

Note:

 1. Pulse Test: Pulse Width  $\leq 300\ \mu\text{s}$ , Duty Cycle  $\leq 2.0\%$ .

# Typical Electrical Characteristics

2N7000 / 2N7002 / NDS7002A

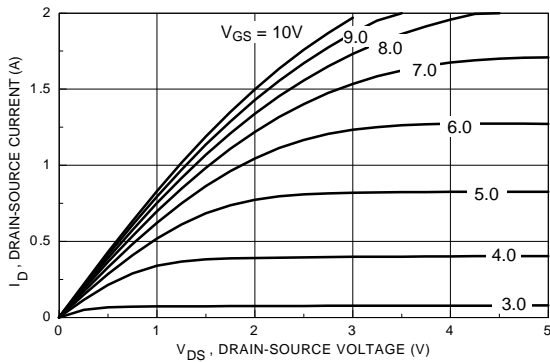

Figure 1. On-Region Characteristics

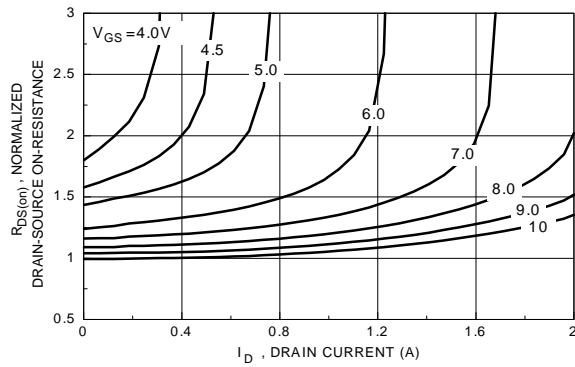

Figure 2. On-Resistance Variation with Gate Voltage and Drain Current

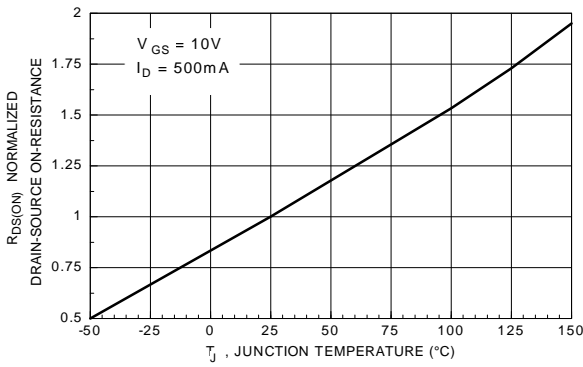

Figure 3. On-Resistance Variation with Temperature

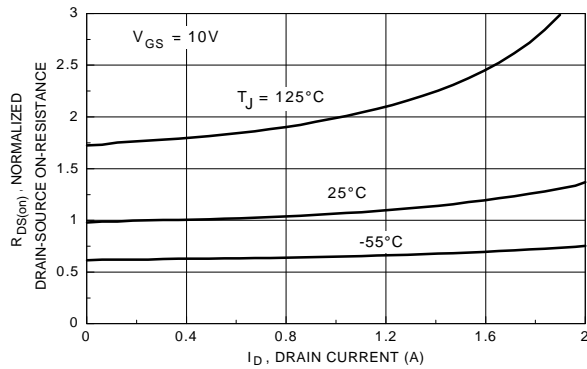

Figure 4. On-Resistance Variation with Drain Current and Temperature

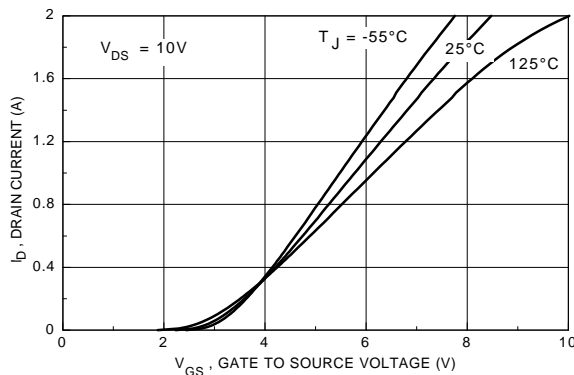

Figure 5. Transfer Characteristics

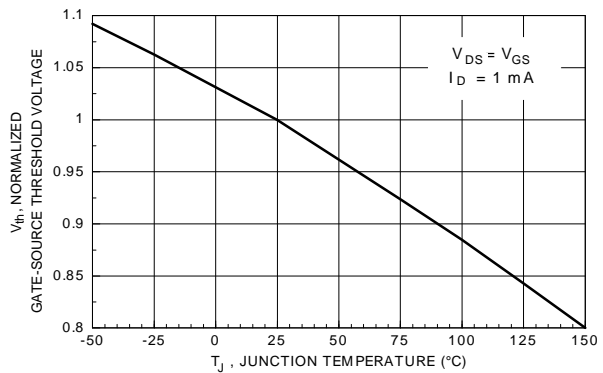

Figure 6. Gate Threshold Variation with Temperature

## Typical Electrical Characteristics (continued)

2N7000 / 2N7002 / NDS7002A

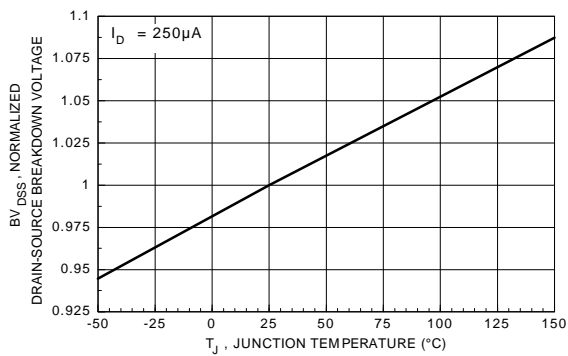

Figure 7. Breakdown Voltage Variation with Temperature

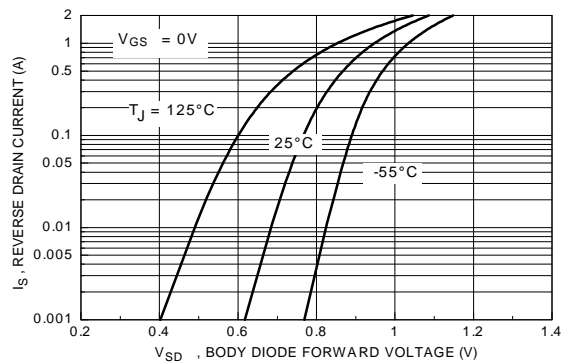

Figure 8. Body Diode Forward Voltage Variation with Temperature

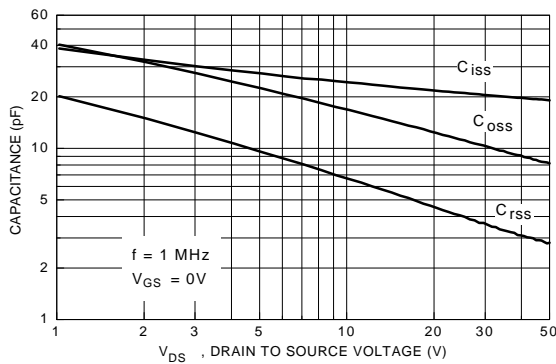

Figure 9. Capacitance Characteristics

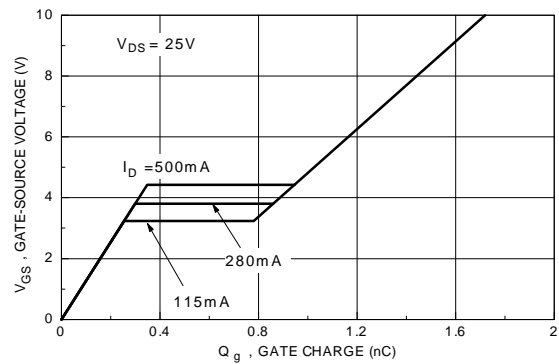

Figure 10. Gate Charge Characteristics

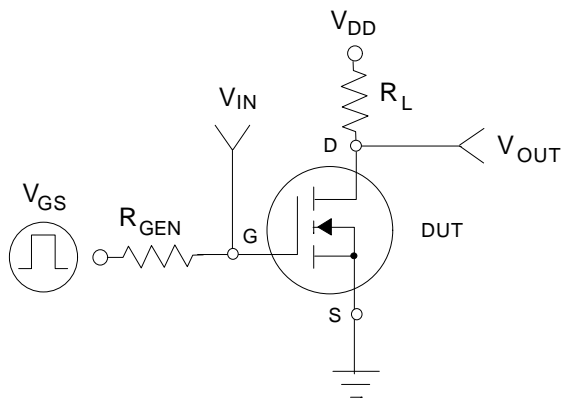

Figure 11.

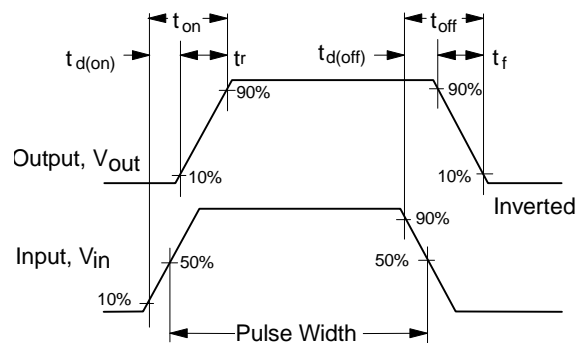
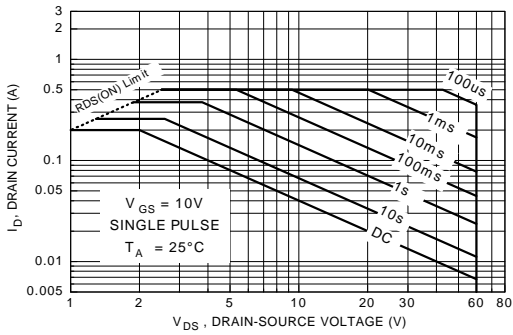
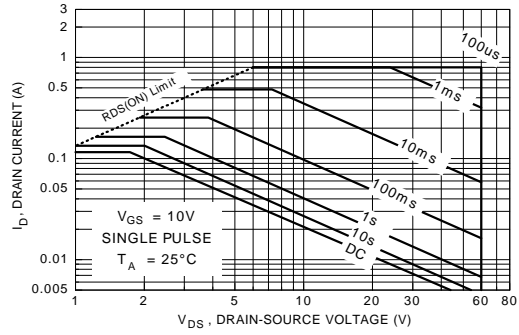

Figure 12. Switching Waveforms

### Typical Electrical Characteristics (continued)



**Figure 13. 2N7000 Maximum Safe Operating Area**



**Figure 14. 2N7002 Maximum Safe Operating Area**

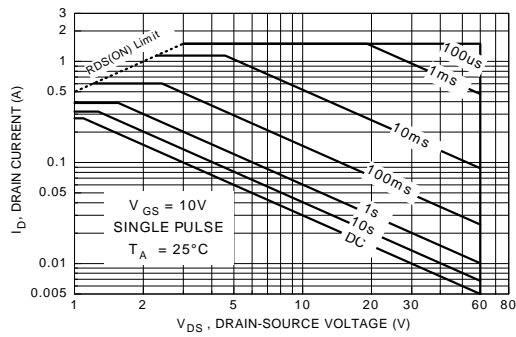

**Figure 15. NDS7000A Maximum Safe Operating Area**

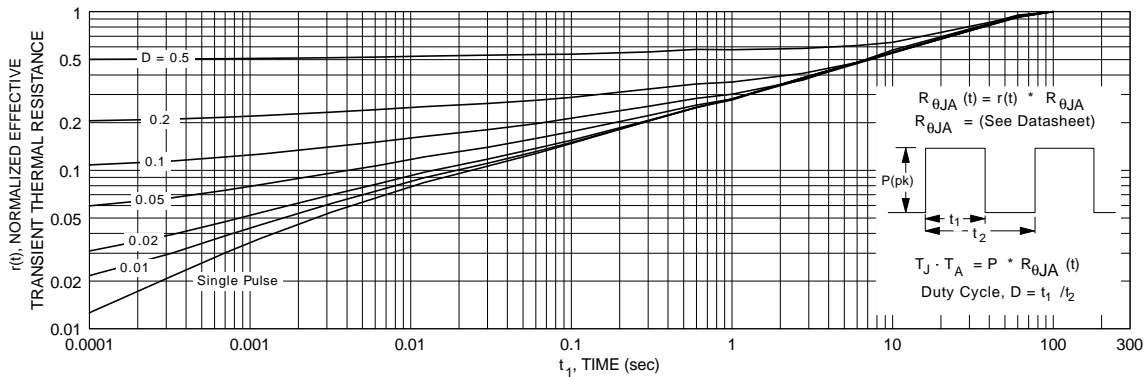

**Figure 16. TO-92, 2N7000 Transient Thermal Response Curve**

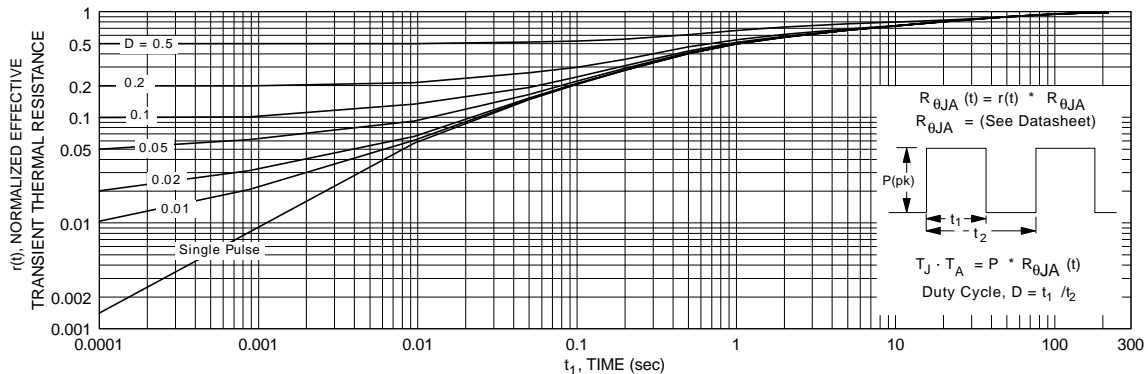

**Figure 17. SOT-23, 2N7002 / NDS7002A Transient Thermal Response Curve**

# TO-92 Tape and Reel Data



## TO-92 Packaging Configuration: Figure 1.0

FSCINT Label sample



F63TNR Label sample



### TO-92 TNR/AMMO PACKING INFORMATION

Packing	Style	Quantity	EOL code
Reel	A	2,000	D26Z
	E	2,000	D27Z
Ammo	M	2,000	D74Z
	P	2,000	D75Z

Unit weight = 0.22 gm  
 Reel weight with components = 1.04 kg  
 Ammo weight with components = 1.02 kg  
 Max quantity per intermediate box = 10,000 units

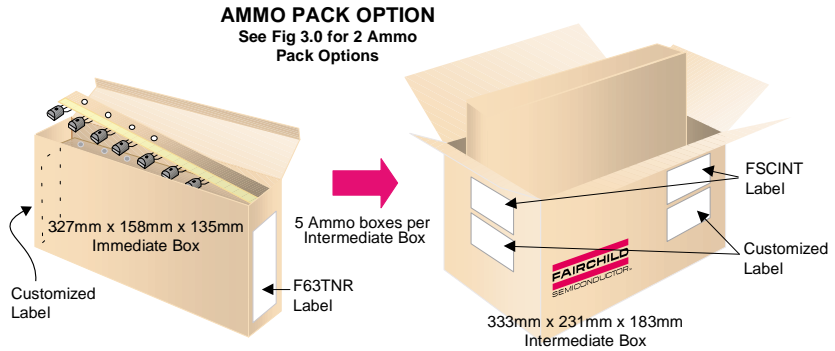

### (TO-92) BULK PACKING INFORMATION

EOL CODE	DESCRIPTION	LEADCLIP DIMENSION	QUANTITY
J18Z	TO-18 OPTION STD	NO LEAD CLIP	2.0 K / BOX
J05Z	TO-5 OPTION STD	NO LEAD CLIP	1.5 K / BOX
NO EOL CODE	TO-92 STANDARD STRAIGHT FOR: PKG 92, 94 (NON PROELECTRON SERIES), 96	NO LEADCLIP	2.0 K / BOX
L34Z	TO-92 STANDARD STRAIGHT FOR: PKG 94 (PROELECTRON SERIES BCXXX, BFXXX, BSRXXX), 97, 98	NO LEADCLIP	2.0 K / BOX

### BULK OPTION

See Bulk Packing Information table

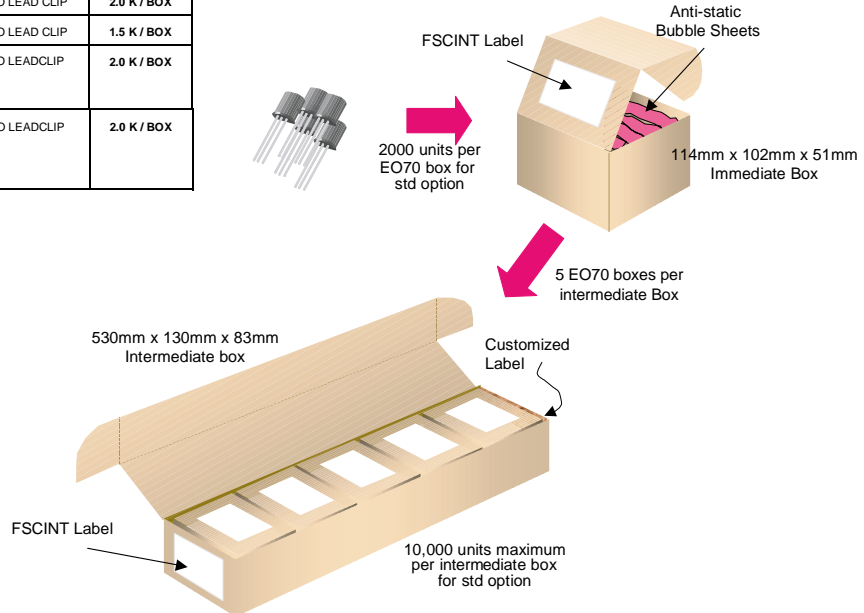

## TO-92 Tape and Reel Data, continued

### TO-92 Reeling Style

Configuration: Figure 2.0

#### Machine Option "A" (H)



Style "A", D26Z, D70Z (s/h)

#### Machine Option "E" (J)



Style "E", D27Z, D71Z (s/h)

### TO-92 Radial Ammo Packaging

Configuration: Figure 3.0

FIRST WIRE OFF IS COLLECTOR  
ADHESIVE TAPE IS ON THE TOP SIDE  
FLAT OF TRANSISTOR IS ON TOP



ORDER STYLE  
D74Z (M)

FIRST WIRE OFF IS EMITTER (ON PKG. 92)  
ADHESIVE TAPE IS ON BOTTOM SIDE  
FLAT OF TRANSISTOR IS ON BOTTOM

FIRST WIRE OFF IS EMITTER  
ADHESIVE TAPE IS ON THE TOP SIDE  
FLAT OF TRANSISTOR IS ON BOTTOM



ORDER STYLE  
D75Z (P)

FIRST WIRE OFF IS COLLECTOR (ON PKG. 92)  
ADHESIVE TAPE IS ON BOTTOM SIDE  
FLAT OF TRANSISTOR IS ON TOP



# TO-92 Tape and Reel Data, continued

**TO-92 Tape and Reel Taping  
Dimension Configuration: Figure 4.0**

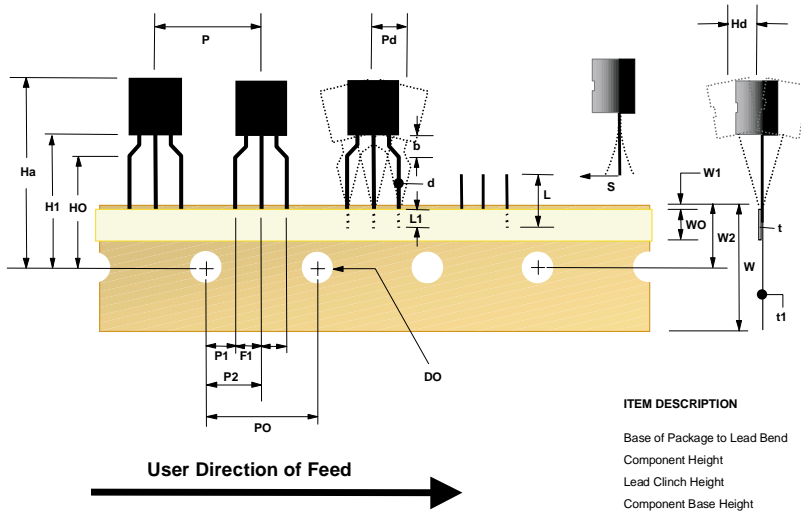

ITEM DESCRIPTION	SYMBOL	DIMENSION
Base of Package to Lead Bend	b	0.098 (max)
Component Height	Ha	0.928 (+/- 0.025)
Lead Clinch Height	HO	0.630 (+/- 0.020)
Component Base Height	H1	0.748 (+/- 0.020)
Component Alignment ( side/side )	Pd	0.040 (max)
Component Alignment ( front/back )	Hd	0.031 (max)
Component Pitch	P	0.500 (+/- 0.020)
Feed Hole Pitch	PO	0.500 (+/- 0.008)
Hole Center to First Lead	P1	0.150 (+0.009, -0.010)
Hole Center to Component Center	P2	0.247 (+/- 0.007)
Lead Spread	F1/F2	0.104 (+/- 0.010)
Lead Thickness	d	0.018 (+0.002, -0.003)
Cut Lead Length	L	0.429 (max)
Taped Lead Length	L1	0.209 (+0.051, -0.052)
Taped Lead Thickness	t	0.032 (+/- 0.006)
Carrier Tape Thickness	t1	0.021 (+/- 0.006)
Carrier Tape Width	W	0.708 (+0.020, -0.019)
Hold - down Tape Width	WO	0.236 (+/- 0.012)
Hold - down Tape position	W1	0.035 (max)
Feed Hole Position	W2	0.360 (+/- 0.025)
Sprocket Hole Diameter	DO	0.157 (+0.008, -0.007)
Lead Spring Out	S	0.004 (max)

Note : All dimensions are in inches.

**TO-92 Reel  
Configuration: Figure 5.0**



ITEM DESCRIPTION	SYMBOL	MINIMUM	MAXIMUM
Reel Diameter	D1	13.975	14.025
Arbor Hole Diameter (Standard)	D2	1.160	1.200
(Small Hole)	D2	0.650	0.700
Core Diameter	D3	3.100	3.300
Hub Recess Inner Diameter	D4	2.700	3.100
Hub Recess Depth	W1	0.370	0.570
Flange to Flange Inner Width	W2	1.630	1.690
Hub to Hub Center Width	W3		2.090

Note: All dimensions are in inches

# TO-92 Package Dimensions



## TO-92 (FS PKG Code 92, 94, 96)

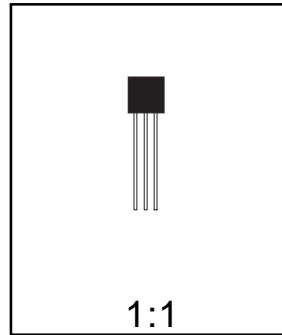
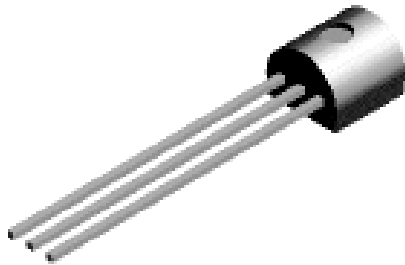

Scale 1:1 on letter size paper

Dimensions shown below are in:  
inches [millimeters]

Part Weight per unit (gram): 0.1977

TO-92 (92,94,96)

PIN	92		94		96	
	B	F	B	F	B	F
1	E	D	E	D	B	S
2	B	S	C	G	E	D
3	C	G	B	S	C	G

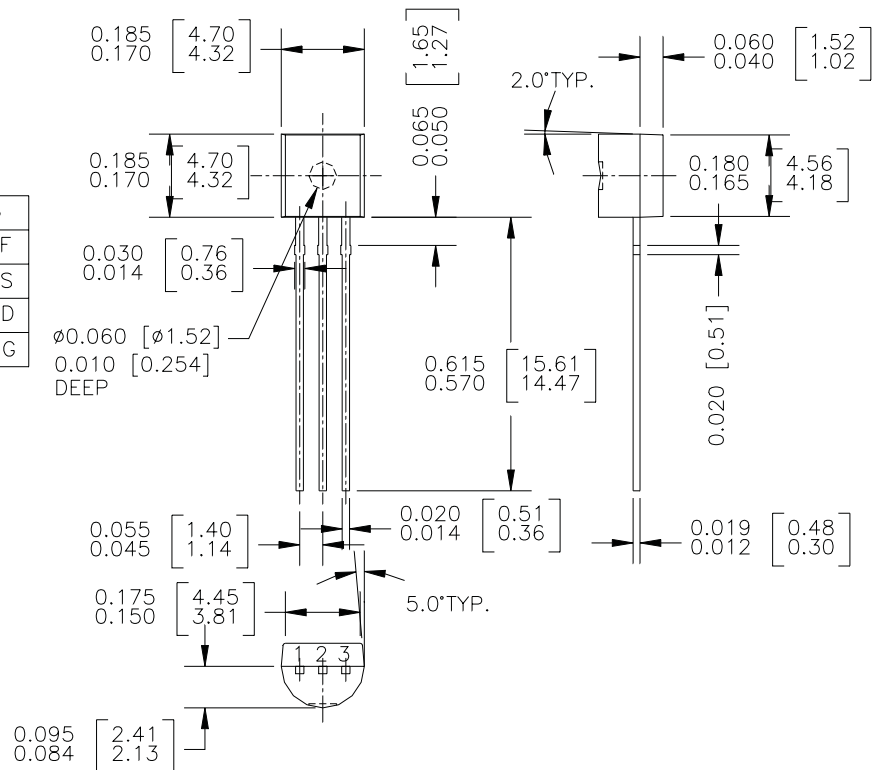

# SOT-23 Tape and Reel Data



## SOT-23 Packaging Configuration: Figure 10



### Packaging Description:

SOT-23 parts are shipped in tape. The carrier tape is made from a dissipative (carbon filled) polycarbonate resin. The cover tape is a multilayer film (Heat Activated Adhesive in nature) primarily composed of polyester film, adhesive layer, sealant, and anti-static sprayed agent. These reeled parts in standard option are shipped with 3,000 units per 7" or 177mm diameter reel. The reels are dark blue in color and is made of polystyrene plastic (anti-static coated). Other option comes in 10,000 units per 13" or 330mm diameter reel. This and some other options are described in the Packaging Information table.

These full reels are individually labeled and placed inside a standard intermediate made of recyclable corrugated brown paper with a Fairchild logo printing. One pizza box contains eight reels maximum. And these intermediate boxes are placed inside a labeled shipping box which comes in different sizes depending on the number of parts shipped.

SOT-23 Packaging Information		
Packaging Option	Standard (no flow code)	D87Z
Packaging type	TNR	TNR
Qty per Reel/Tube/Bag	3,000	10,000
Reel Size	7" Dia	13"
Box Dimension (mm)	187x107x183	343x343x64
Max qty per Box	24,000	30,000
Weight per unit (gm)	0.0082	0.0082
Weight per Reel (kg)	0.1175	0.4006
Note/Comments		

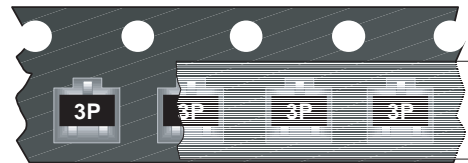

### SOT-23 Unit Orientation

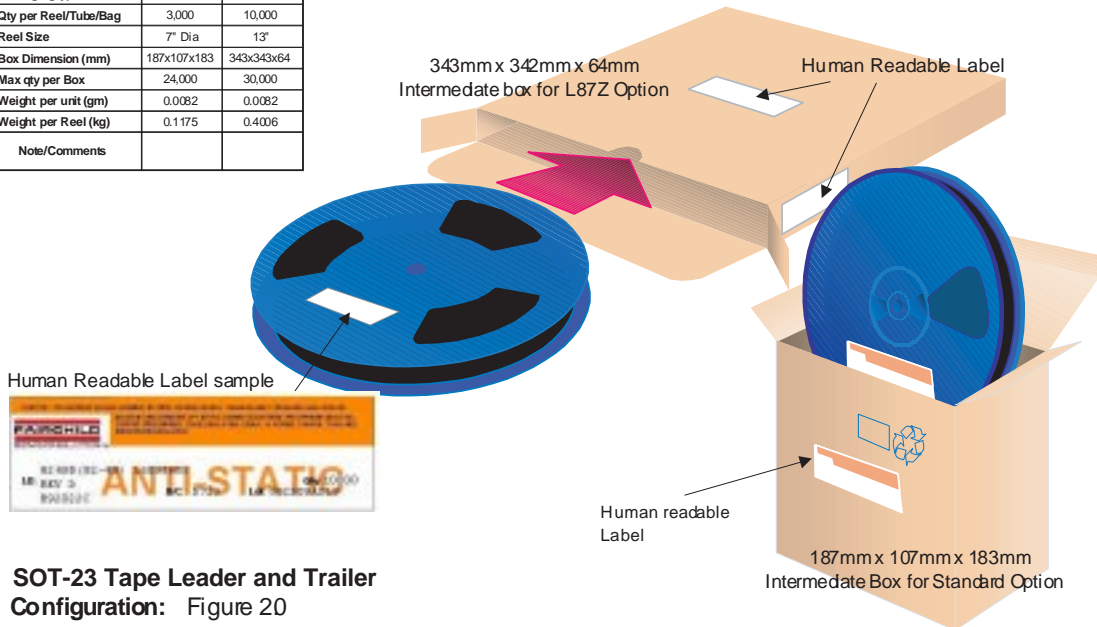

Human Readable Label sample



## SOT-23 Tape Leader and Trailer Configuration: Figure 20

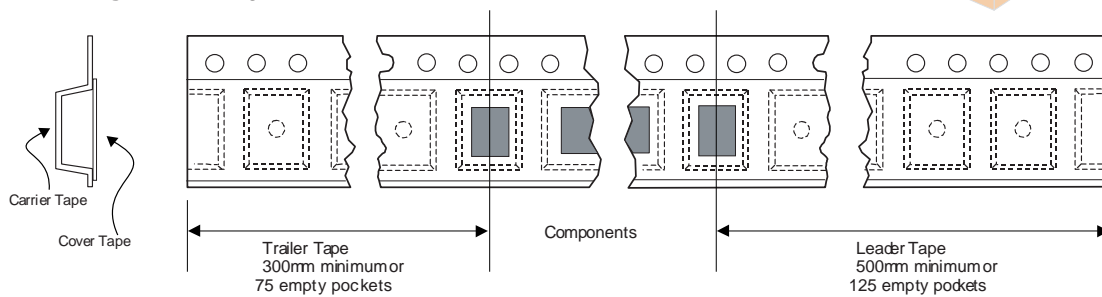

# SOT-23 Tape and Reel Data, continued

## SOT-23 Embossed Carrier Tape Configuration: Figure 3.0



Dimensions are in millimeter

Pkg type	A0	B0	W	D0	D1	E1	E2	F	P1	P0	K0	T	Wc	Tc
SOT-23 (8mm)	3.15 ±0.10	2.77 ±0.10	8.0 ±0.3	1.55 ±0.05	1.125 ±0.125	1.75 ±0.10	6.25 min	3.50 ±0.05	4.0 ±0.1	4.0 ±0.1	1.30 ±0.10	0.228 ±0.013	5.2 ±0.3	0.06 ±0.02

Notes: A0, B0, and K0 dimensions are determined with respect to the EIA/Jedec RS-481 rotational and lateral movement requirements (see sketches A, B, and C).

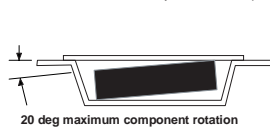

Sketch A (Side or Front Sectional View)  
Component Rotation

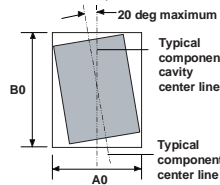

Sketch B (Top View)  
Component Rotation



Sketch C (Top View)  
Component lateral movement

## SOT-23 Reel Configuration: Figure 4.0

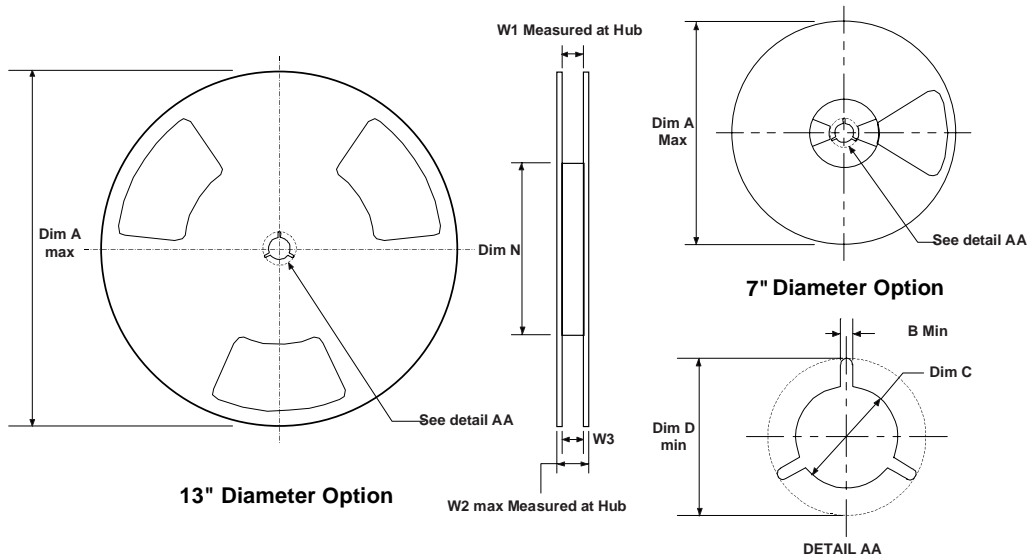

Dimensions are in inches and millimeters

Tape Size	Reel Option	Dim A	Dim B	Dim C	Dim D	Dim N	Dim W1	Dim W2	Dim W3 (LSL-USL)
8mm	7" Dia	7.00 177.8	0.059 1.5	512 +0.020/-0.008 13 +0.5/-0.2	0.795 20.2	2.165 55	0.331 +0.059/-0.000 8.4 +1.5/0	0.567 14.4	0.311 -0.429 7.9 - 10.9
8mm	13" Dia	13.00 330	0.059 1.5	512 +0.020/-0.008 13 +0.5/-0.2	0.795 20.2	4.00 100	0.331 +0.059/-0.000 8.4 +1.5/0	0.567 14.4	0.311 -0.429 7.9 - 10.9

# SOT-23 Package Dimensions



## SOT-23 (FS PKG Code 49)

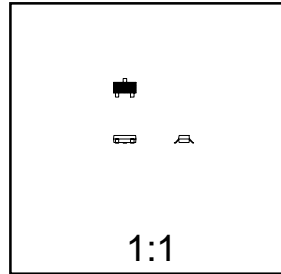

Scale 1:1 on letter size paper

Dimensions shown below are in:  
inches [millimeters]

Part Weight per unit (gram): 0.0082

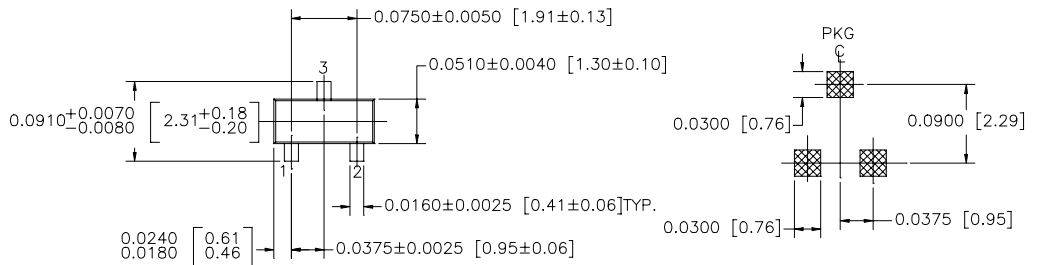

LAND PATTERN RECOMMENDATION

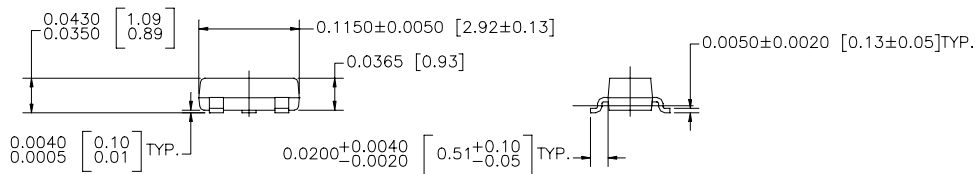

CONTROLLING DIMENSION IS INCH  
VALUES IN [ ] ARE MILLIMETERS

SOT 23, 3 LEADS LOW PROFILE

NOTE : UNLESS OTHERWISE SPECIFIED

- STANDARD LEAD FINISH 150 MICRONS / 3.81 MICROMETERS  
MINIMUM TIN / LEAD (SOLDER) ON ALLOY 42
- REFERENCE JEDEC REGISTRATION TO-236, VARIATION AB, ISSUE G, DATED JUL 1993

## TRADEMARKS

The following are registered and unregistered trademarks Fairchild Semiconductor owns or is authorized to use and is not intended to be an exhaustive list of all such trademarks.

ACEx™	FASTr™	PowerTrench®	SyncFET™
Bottomless™	GlobalOptoisolator™	QFET™	TinyLogic™
CoolFET™	GTO™	QS™	UHC™
CROSSVOLT™	HiSeC™	QT Optoelectronics™	VCX™
DOME™	ISOPLANAR™	Quiet Series™	
E <sup>2</sup> CMOS™	MICROWIRE™	SILENT SWITCHER®	
EnSigna™	OPTOLOGIC™	SMART START™	
FACT™	OPTOPLANAR™	SuperSOT™-3	
FACT Quiet Series™	PACMAN™	SuperSOT™-6	
FAST®	POP™	SuperSOT™-8	

## DISCLAIMER

FAIRCHILD SEMICONDUCTOR RESERVES THE RIGHT TO MAKE CHANGES WITHOUT FURTHER NOTICE TO ANY PRODUCTS HEREIN TO IMPROVE RELIABILITY, FUNCTION OR DESIGN. FAIRCHILD DOES NOT ASSUME ANY LIABILITY ARISING OUT OF THE APPLICATION OR USE OF ANY PRODUCT OR CIRCUIT DESCRIBED HEREIN; NEITHER DOES IT CONVEY ANY LICENSE UNDER ITS PATENT RIGHTS, NOR THE RIGHTS OF OTHERS.

## LIFE SUPPORT POLICY

FAIRCHILD'S PRODUCTS ARE NOT AUTHORIZED FOR USE AS CRITICAL COMPONENTS IN LIFE SUPPORT DEVICES OR SYSTEMS WITHOUT THE EXPRESS WRITTEN APPROVAL OF FAIRCHILD SEMICONDUCTOR CORPORATION. As used herein:

1. Life support devices or systems are devices or systems which, (a) are intended for surgical implant into the body, or (b) support or sustain life, or (c) whose failure to perform when properly used in accordance with instructions for use provided in the labeling, can be reasonably expected to result in significant injury to the user.
2. A critical component is any component of a life support device or system whose failure to perform can be reasonably expected to cause the failure of the life support device or system, or to affect its safety or effectiveness.

## PRODUCT STATUS DEFINITIONS

### Definition of Terms

Datasheet Identification	Product Status	Definition
Advance Information	Formative or In Design	This datasheet contains the design specifications for product development. Specifications may change in any manner without notice.
Preliminary	First Production	This datasheet contains preliminary data, and supplementary data will be published at a later date. Fairchild Semiconductor reserves the right to make changes at any time without notice in order to improve design.
No Identification Needed	Full Production	This datasheet contains final specifications. Fairchild Semiconductor reserves the right to make changes at any time without notice in order to improve design.
Obsolete	Not In Production	This datasheet contains specifications on a product that has been discontinued by Fairchild semiconductor. The datasheet is printed for reference information only.