

ES1DAF, ES1JAF

Surface Mount Ultrafast Rectifier

Features

- Fast Switching Speed – Maximum T_{rr} 35 ns
- Ultra Thin Profile – Maximum Height of 1.0 mm
- Glass Passivated Junction
- UL Flammability 94V-0 Classification
- MSL 1
- Green Mold Compound
- These Devices are Pb-Free, Halogen Free and are RoHS Compliant

Specifications

ABSOLUTE MAXIMUM RATINGS ($T_A = 25^\circ\text{C}$ unless otherwise noted)

Symbol	Parameter	Value		Unit
		ES1DAF	ES1JAF	
V_{RRM}	Recurrent Peak Reverse Voltage	200	600	V
V_{RMS}	RMS Voltage	140	420	V
V_R	DC Blocking Voltage	200	600	V
$I_{F(AV)}$	Average Forward Current	1		A
I_{FSM}	Peak Forward Surge Current: 8.3 ms Single Half Sine-Wave Superimposed on Rated Load	30		A
T_J	Operating Junction Temperature Range	-55 to +150		$^\circ\text{C}$
T_{STG}	Storage Temperature Range	-55 to +150		$^\circ\text{C}$

Stresses exceeding those listed in the Maximum Ratings table may damage the device. If any of these limits are exceeded, device functionality should not be assumed, damage may occur and reliability may be affected.



ON Semiconductor®

www.onsemi.com

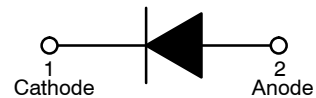

Ultrafast Rectifier

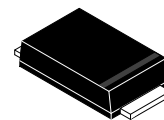

DO-214AD
(SMAF)
CASE 403AD

MARKING DIAGRAMS

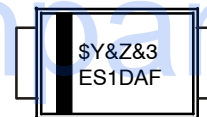

Band Indicates Cathode

- \$Y = ON Semiconductor Logo
- &Z = Assembly Plant Code
- &3 = Data Code (Year & Week)
- ES1DAF = Specific Device Code

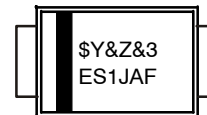

Band Indicates Cathode

- \$Y = ON Semiconductor Logo
- &Z = Assembly Plant Code
- &3 = Data Code (Year & Week)
- ES1JAF = Specific Device Code

ORDERING INFORMATION

See detailed ordering and shipping information on page 2 of this data sheet.

ES1DAF, ES1JAF

THERMAL CHARACTERISTICS ($T_A = 25^\circ\text{C}$ unless otherwise noted)

Symbol	Characteristic	Value	Unit
Ψ_{JL}	Typical Thermal Characteristics, Junction-to-Lead (Note 1)	24	$^\circ\text{C/W}$
$R_{\theta JA}$	Typical Thermal Resistance, Junction-to-Ambient (Note 2)	150	$^\circ\text{C/W}$

1. Mounted on an FR4 PCB, single-sided copper, with 48 cm² copper pad area.
2. Mounted on an FR4 PCB, single-sided copper, mini pad.

ELECTRICAL CHARACTERISTICS ($T_A = 25^\circ\text{C}$ unless otherwise noted)

Symbol	Parameter	Conditions	Min	Typ	Max	Unit	
V_F	Forward Voltage	$I_F = 1\text{ A}$	ES1DAF	-	-	0.95	V
			ES1JAF	-	-	1.70	
I_R	Reverse Current	$V_R = V_{DC}$	-	-	1	μA	
t_{rr}	Reverse Recovery Time	$I_F = 0.5\text{ A}$, $I_R = 1\text{ A}$, $I_{rr} = 0.25\text{ A}$	-	-	34	ns	
C_J	Junction Capacitance	$V_R = 4\text{ V}$, $f = 1\text{ MHz}$	-	15	-	pF	

Product parametric performance is indicated in the Electrical Characteristics for the listed test conditions, unless otherwise noted. Product performance may not be indicated by the Electrical Characteristics if operated under different conditions.

ORDERING INFORMATION

Part Number	Top Mark	Package	Shipping [†]
ES1DAF	ES1DAF	DO-214AD (SMAF) (Pb-Free/Halogen Free)	10000 / Tape & Reel
ES1JAF	ES1JAF	DO-214AD (SMAF) (Pb-Free/Halogen Free)	10000 / Tape & Reel

[†]For information on tape and reel specifications, including part orientation and tape sizes, please refer to our Tape and Reel Packaging Specifications Brochure, BRD8011/D.

TYPICAL PERFORMANCE CHARACTERISTICS

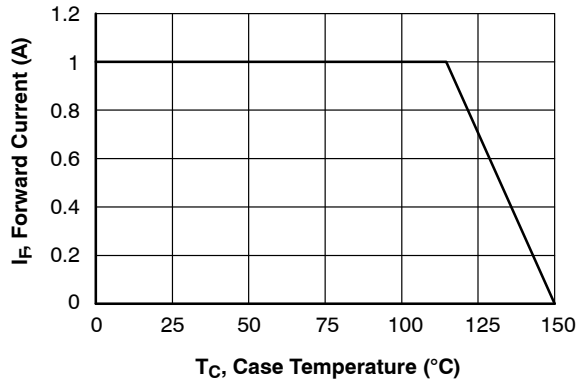

Figure 1. Forward Current Derating Curve

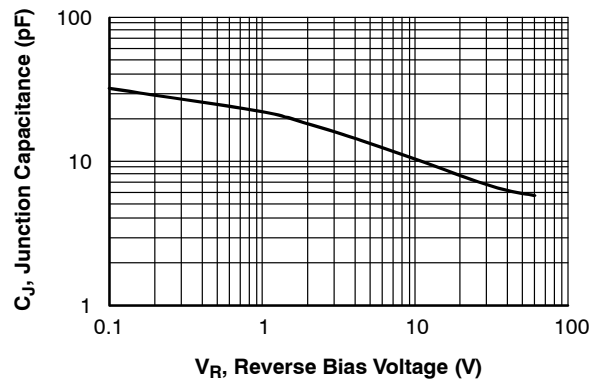

Figure 2. Typical Junction Capacitance

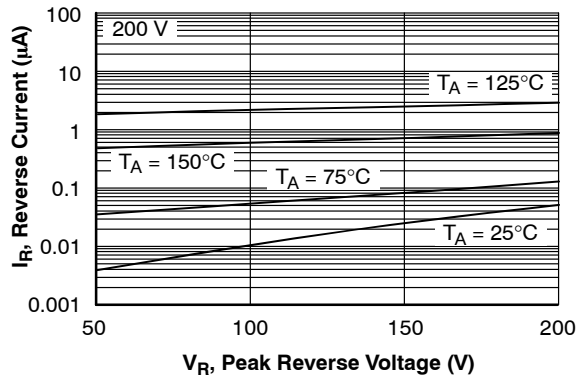

Figure 3. Typical Reverse Characteristics

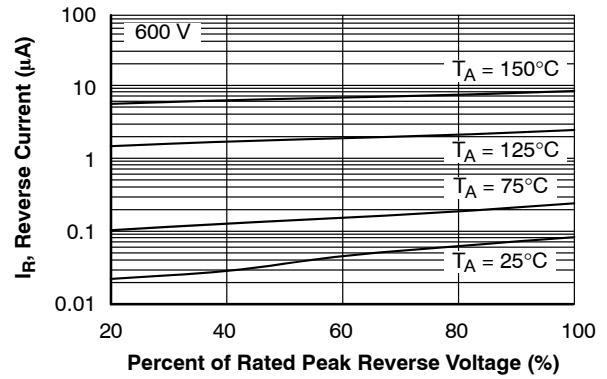

Figure 4. Typical Reverse Characteristics

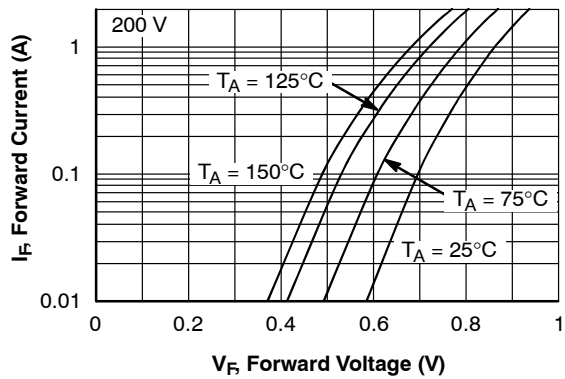

Figure 5. Typical Forward Characteristics

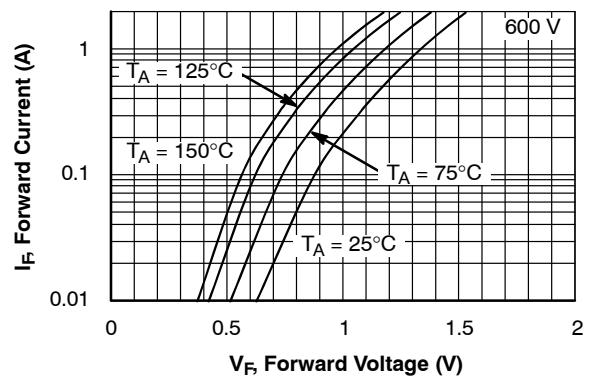
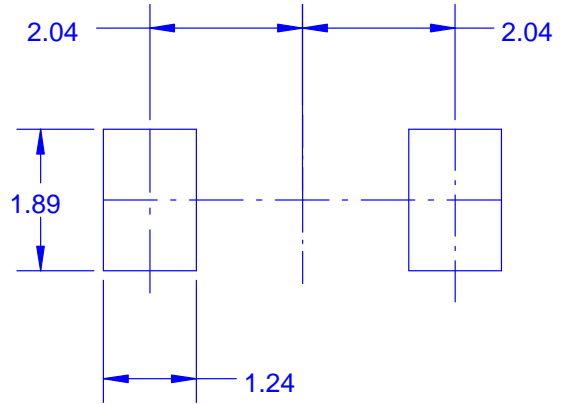
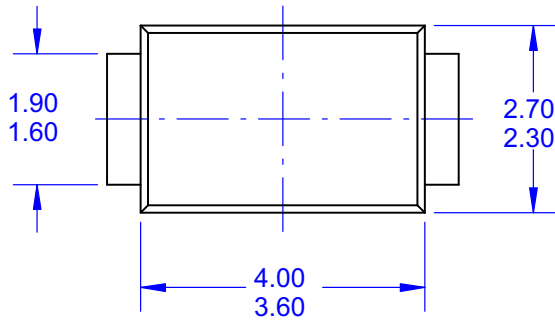

Figure 6. Typical Forward Characteristics



SMA-FL
CASE 403AD
ISSUE O

DATE 31 AUG 2016



LAND PATTERN RECOMMENDATION

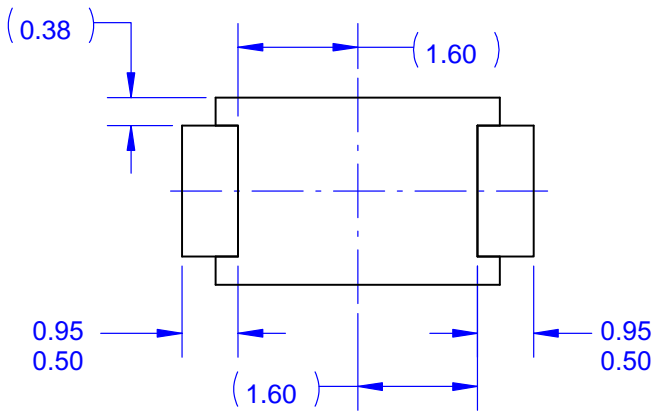
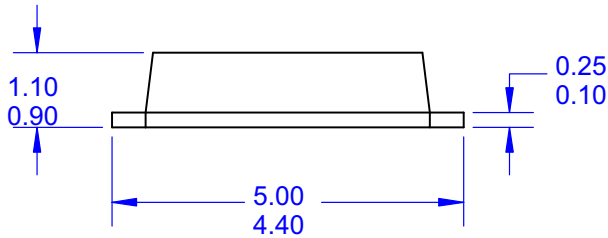

NOTES:

- A. THIS PACKAGE DOES NOT CONFORM TO ANY STANDARDS.
- B. ALL DIMENSIONS ARE IN MILLIMETERS.
- C. DIMENSIONS ARE EXCLUSIVE OF BURRS, MOLD FLASH AND TIE BAR PROTRUSIONS.

DOCUMENT NUMBER:	98AON13439G	Electronic versions are uncontrolled except when accessed directly from the Document Repository. Printed versions are uncontrolled except when stamped "CONTROLLED COPY" in red.
STATUS:	ON SEMICONDUCTOR STANDARD	
NEW STANDARD:		
DESCRIPTION:	SMA-FL	PAGE 1 OF 2

ON Semiconductor and  are trademarks of Semiconductor Components Industries, LLC dba ON Semiconductor or its subsidiaries in the United States and/or other countries. ON Semiconductor owns the rights to a number of patents, trademarks, copyrights, trade secrets, and other intellectual property. A listing of ON Semiconductor's product/patent coverage may be accessed at www.onsemi.com/site/pdf/Patent-Marking.pdf. ON Semiconductor reserves the right to make changes without further notice to any products herein. ON Semiconductor makes no warranty, representation or guarantee regarding the suitability of its products for any particular purpose, nor does ON Semiconductor assume any liability arising out of the application or use of any product or circuit, and specifically disclaims any and all liability, including without limitation special, consequential or incidental damages. Buyer is responsible for its products and applications using ON Semiconductor products, including compliance with all laws, regulations and safety requirements or standards, regardless of any support or applications information provided by ON Semiconductor. "Typical" parameters which may be provided in ON Semiconductor data sheets and/or specifications can and do vary in different applications and actual performance may vary over time. All operating parameters, including "Typicals" must be validated for each customer application by customer's technical experts. ON Semiconductor does not convey any license under its patent rights nor the rights of others. ON Semiconductor products are not designed, intended, or authorized for use as a critical component in life support systems or any FDA Class 3 medical devices or medical devices with a same or similar classification in a foreign jurisdiction or any devices intended for implantation in the human body. Should Buyer purchase or use ON Semiconductor products for any such unintended or unauthorized application, Buyer shall indemnify and hold ON Semiconductor and its officers, employees, subsidiaries, affiliates, and distributors harmless against all claims, costs, damages, and expenses, and reasonable attorney fees arising out of, directly or indirectly, any claim of personal injury or death associated with such unintended or unauthorized use, even if such claim alleges that ON Semiconductor was negligent regarding the design or manufacture of the part. ON Semiconductor is an Equal Opportunity/Affirmative Action Employer. This literature is subject to all applicable copyright laws and is not for resale in any manner.

PUBLICATION ORDERING INFORMATION

LITERATURE FULFILLMENT:

Literature Distribution Center for ON Semiconductor
19521 E. 32nd Pkwy, Aurora, Colorado 80011 USA
Phone: 303-675-2175 or 800-344-3860 Toll Free USA/Canada
Fax: 303-675-2176 or 800-344-3867 Toll Free USA/Canada
Email: orderlit@onsemi.com

N. American Technical Support: 800-282-9855 Toll Free
USA/Canada
Europe, Middle East and Africa Technical Support:
Phone: 421 33 790 2910

ON Semiconductor Website: www.onsemi.com

Order Literature: <http://www.onsemi.com/orderlit>

For additional information, please contact your local
Sales Representative