

## Optocoupler, Phototransistor Output, with Base Connection

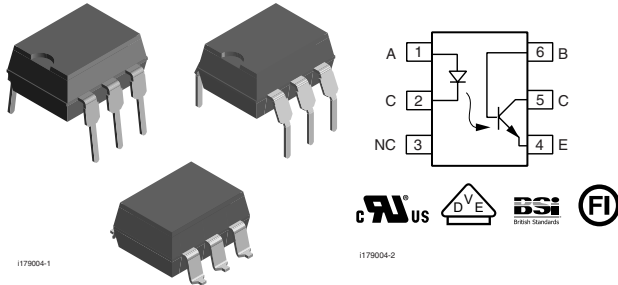

### DESCRIPTION

This data sheet presents five families of Vishay industry standard single channel phototransistor couplers. These families include the 4N35, 4N36, 4N37, 4N38 couplers. Each optocoupler consists of gallium arsenide infrared LED and a silicon NPN phototransistor.

These couplers are Underwriters Laboratories (UL) listed to comply with a 5300 V<sub>RMS</sub> isolation test voltage.

This isolation performance is accomplished through Vishay double molding isolation manufacturing process. Compliance to DIN EN 60747-5-5 partial discharge isolation specification is available for these families by ordering option 1.

These isolation processes and the Vishay ISO9001 quality program results in the highest isolation performance available for a commercial plastic phototransistor optocoupler.

The devices are available in lead formed configuration suitable for surface mounting and are available either on tape and reel, or in standard tube shipping containers.

Note:

For additional design information see application note 45 normalized curves

### FEATURES

- Isolation test voltage 5300 V<sub>RMS</sub>
- Interfaces with common logic families
- Input-output coupling capacitance < 0.5 pF
- Industry standard dual-in-line 6 pin package
- Compliant to RoHS directive 2002/95/EC and in accordance to WEEE 2002/96/EC



**RoHS**  
COMPLIANT

### APPLICATIONS

- AC mains detection
- Reed relay driving
- Switch mode power supply feedback
- Telephone ring detection
- Logic ground isolation
- Logic coupling with high frequency noise rejection

### AGENCY APPROVALS

- Underwriters laboratory file no. E52744
- DIN EN 60747-5-5 (VDE 0884) available with option 1

### ORDER INFORMATION

PART	REMARKS
4N35-X000	CTR > 100 %, DIP-6
4N36-X000	CTR > 100 %, DIP-6
4N37-X000	CTR > 100 %, DIP-6
4N38	CTR > 20 %, DIP-6
4N35-X006	CTR > 100 %, DIP-6 400 mil (option 6)
4N35-X007	CTR > 100 %, SMD-6 (option 7)
4N35-X009	CTR > 100 %, SMD-6 (option 9)
4N36-X007	CTR > 100 %, SMD-6 (option 7)
4N36-X009	CTR > 100 %, SMD-6 (option 9)
4N37-X006	CTR > 100 %, DIP-6 400 mil (option 6)
4N38-X009	CTR > 100 %, SMD-6 (option 9)

### Note

For additional information on the available options refer to option information.

# 4N35-X, 4N36-X, 4N37-X, 4N38



Vishay Semiconductors Optocoupler, Phototransistor Output,  
with Base Connection

ABSOLUTE MAXIMUM RATINGS <sup>(1)</sup>				
PARAMETER	TEST CONDITION	SYMBOL	VALUE	UNIT
<b>INPUT</b>				
Reverse voltage		$V_R$	6	V
Forward current		$I_F$	60	mA
Surge current	$t \leq 10 \mu\text{s}$	$I_{FSM}$	2.5	A
Power dissipation		$P_{diss}$	100	mW
<b>OUTPUT</b>				
Collector emitter breakdown voltage		$V_{CEO}$	70	V
Emitter base breakdown voltage		$V_{EBO}$	7	V
Collector current		$I_C$	50	mA
	$t \leq 1 \text{ ms}$	$I_C$	100	mA
Power dissipation		$P_{diss}$	150	mW
<b>COUPLER</b>				
Isolation test voltage		$V_{ISO}$	5300	$V_{RMS}$
Creepage			$\geq 7$	mm
Clearance			$\geq 7$	mm
Isolation thickness between emitter and detector			$\geq 0.4$	mm
Comparative tracking index	DIN IEC 112/VDE 0303, part 1		175	
Isolation resistance	$V_{IO} = 500 \text{ V}, T_{amb} = 25 \text{ }^\circ\text{C}$	$R_{IO}$	$10^{12}$	$\Omega$
	$V_{IO} = 500 \text{ V}, T_{amb} = 100 \text{ }^\circ\text{C}$	$R_{IO}$	$10^{11}$	$\Omega$
Storage temperature		$T_{stg}$	- 55 to + 150	$^\circ\text{C}$
Operating temperature		$T_{amb}$	- 55 to + 100	$^\circ\text{C}$
Junction temperature		$T_j$	100	$^\circ\text{C}$
Soldering temperature <sup>(2)</sup>	max. 10 s dip soldering: distance to seating plane $\geq 1.5 \text{ mm}$	$T_{sld}$	260	$^\circ\text{C}$

## Notes

<sup>(1)</sup>  $T_{amb} = 25 \text{ }^\circ\text{C}$ , unless otherwise specified.

Stresses in excess of the absolute maximum ratings can cause permanent damage to the device. Functional operation of the device is not implied at these or any other conditions in excess of those given in the operational sections of this document. Exposure to absolute maximum ratings for extended periods of the time can adversely affect reliability.

<sup>(2)</sup> Refer to reflow profile for soldering conditions for surface mounted devices (SMD). Refer to wave profile for soldering conditions for through hole devices (DIP).

ELECTRICAL CHARACTERISTICS <sup>(1)</sup>							
PARAMETER	TEST CONDITION	PART	SYMBOL	MIN.	TYP.	MAX.	UNIT
<b>INPUT</b>							
Junction capacitance	$V_R = 0 \text{ V}, f = 1 \text{ MHz}$		$C_j$		50		pF
Forward voltage <sup>(2)</sup>	$I_F = 10 \text{ mA}$		$V_F$		1.3	1.5	V
	$I_F = 10 \text{ mA}, T_{amb} = - 55 \text{ }^\circ\text{C}$		$V_F$	0.9	1.3	1.7	V
Reverse current <sup>(2)</sup>	$V_R = 6 \text{ V}$		$I_R$		0.1	10	$\mu\text{A}$
Capacitance	$V_R = 0 \text{ V}, f = 1 \text{ MHz}$		$C_O$		25		pF
<b>OUTPUT</b>							
Collector emitter breakdown voltage <sup>(2)</sup>	$I_C = 1 \text{ mA}$	4N35	$BV_{CEO}$	30			V
		4N36	$BV_{CEO}$	30			V
		4N37	$BV_{CEO}$	30			V
		4N38	$BV_{CEO}$	80			V
Emitter collector breakdown voltage <sup>(2)</sup>	$I_E = 100 \mu\text{A}$		$BV_{ECO}$	7			V



# 4N35-X, 4N36-X, 4N37-X, 4N38

Optocoupler, Phototransistor Output, Vishay Semiconductors  
with Base Connection

ELECTRICAL CHARACTERISTICS <sup>(1)</sup>								
PARAMETER	TEST CONDITION	PART	SYMBOL	MIN.	TYP.	MAX.	UNIT	
<b>OUTPUT</b>								
Collector base breakdown voltage <sup>(2)</sup>	$I_C = 100 \mu\text{A}, I_B = 1 \mu\text{A}$	4N35	$BV_{CBO}$	70			V	
		4N36	$BV_{CBO}$	70			V	
		4N37	$BV_{CBO}$	70			V	
		4N38	$BV_{CBO}$	80			V	
Collector emitter leakage current <sup>(2)</sup>	$V_{CE} = 10 \text{ V}, I_F = 0$	4N35	$I_{CEO}$		5	50	nA	
		4N36	$I_{CEO}$		5	50	nA	
	$V_{CE} = 10 \text{ V}, I_F = 0$	4N37	$I_{CEO}$		5	50	nA	
	$V_{CE} = 30 \text{ V}, I_F = 0,$ $T_{amb} = 100 \text{ }^\circ\text{C}$	4N38	$I_{CEO}$				50	nA
		4N35	$I_{CEO}$				500	$\mu\text{A}$
		4N36	$I_{CEO}$				500	$\mu\text{A}$
	$V_{CE} = 60 \text{ V}, I_F = 0,$ $T_{amb} = 100 \text{ }^\circ\text{C}$	4N37	$I_{CEO}$				500	$\mu\text{A}$
4N38	$I_{CEO}$		6			$\mu\text{A}$		
Collector emitter capacitance	$V_{CE} = 0$		$C_{CE}$		6		pF	
<b>COUPLER</b>								
Resistance, input output <sup>(2)</sup>	$V_{IO} = 500 \text{ V}$		$R_{IO}$	$10^{11}$			$\Omega$	
Capacitance, input output	$f = 1 \text{ MHz}$		$C_{IO}$		0.5		pF	

### Notes

<sup>(1)</sup>  $T_{amb} = 25 \text{ }^\circ\text{C}$ , unless otherwise specified.

Minimum and maximum values are testing requirements. Typical values are characteristics of the device and are the result of engineering evaluation. Typical values are for information only and are not part of the testing requirements.

<sup>(2)</sup> Indicates JEDEC registered value.

CURRENT TRANSFER RATIO							
PARAMETER	TEST CONDITION	PART	SYMBOL	MIN	TYP.	MAX	UNIT
DC current transfer ratio <sup>(1)</sup>	$V_{CE} = 10 \text{ V}, I_F = 10 \text{ mA}$	4N35	$CTR_{DC}$	100			%
		4N36	$CTR_{DC}$	100			%
		4N37	$CTR_{DC}$	100			%
	$V_{CE} = 10 \text{ V}, I_F = 20 \text{ mA}$	4N38	$CTR_{DC}$	20			%
	$V_{CE} = 10 \text{ V}, I_F = 10 \text{ mA},$ $T_A = -55 \text{ }^\circ\text{C to } +100 \text{ }^\circ\text{C}$	4N35	$CTR_{DC}$	40	50		%
		4N36	$CTR_{DC}$	40	50		%
		4N37	$CTR_{DC}$	40	50		%
4N38		$CTR_{DC}$		30		%	

### Note

<sup>(1)</sup> Indicates JEDEC registered values.

SWITCHING CHARACTERISTICS							
PARAMETER	TEST CONDITION	SYMBOL	MIN.	TYP.	MAX.	UNIT	
Switching time <sup>(1)</sup>	$V_{CC} = 10 \text{ V}, I_C = 2 \text{ mA}, R_L = 100 \Omega$	$t_{on}, t_{off}$		10		$\mu\text{s}$	

### Note

<sup>(1)</sup> Indicates JEDEC registered values.

## TYPICAL CHARACTERISTICS

$T_{amb} = 25\text{ }^{\circ}\text{C}$ , unless otherwise specified

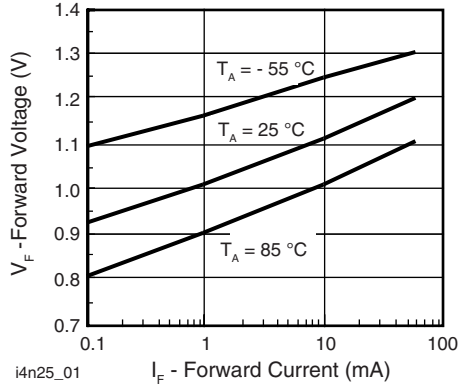

Fig. 1 - Forward Voltage vs. Forward Current

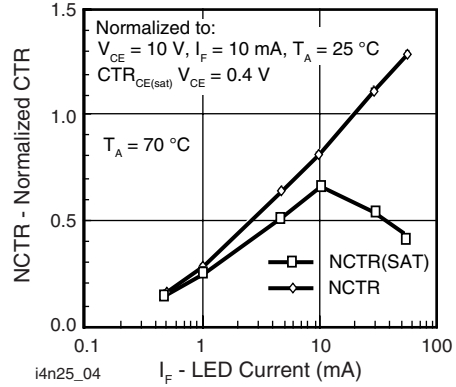

Fig. 4 - Normalized Non-Saturated and Saturated CTR vs. LED Current

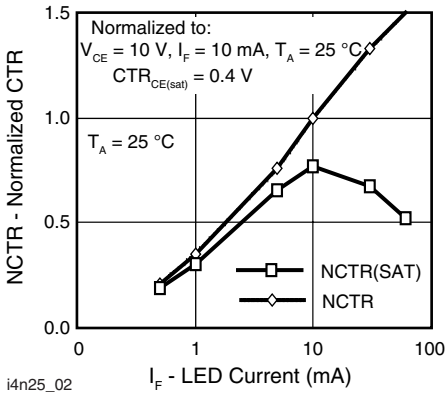

Fig. 2 - Normalized Non-Saturated and Saturated CTR vs. LED Current

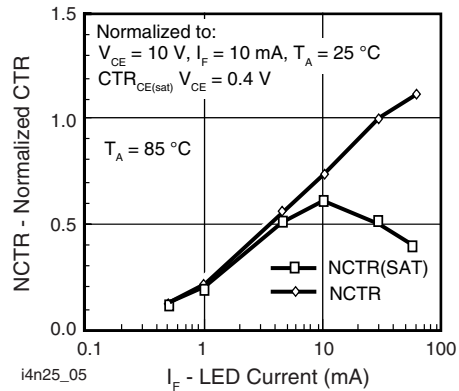

Fig. 5 - Normalized Non-Saturated and Saturated CTR vs. LED Current

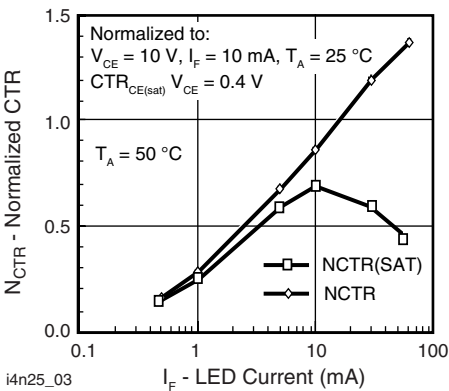

Fig. 3 - Normalized Non-Saturated and Saturated CTR vs. LED Current

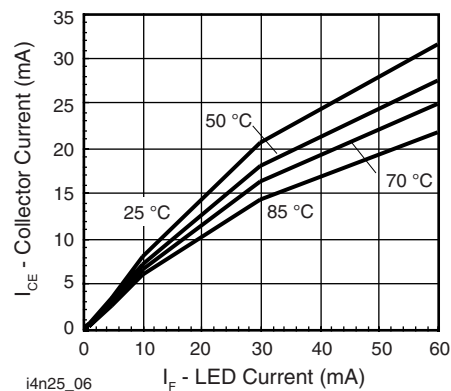

Fig. 6 - Collector Emitter Current vs. Temperature and LED Current

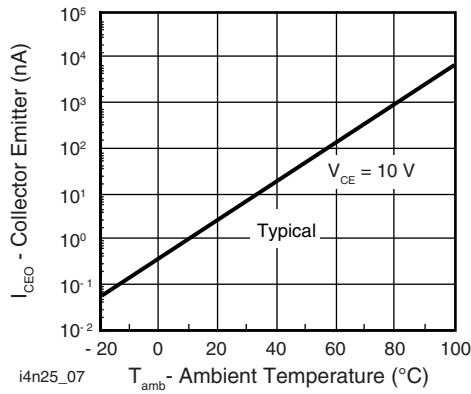

Fig. 7 - Collector Emitter Leakage Current vs. Temperature

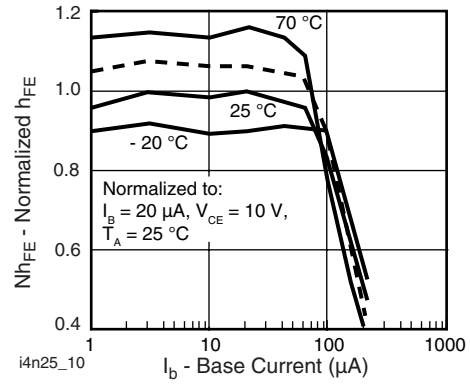

Fig. 10 - Normalized Non-Saturated  $h_{FE}$  vs. Base Current and Temperature

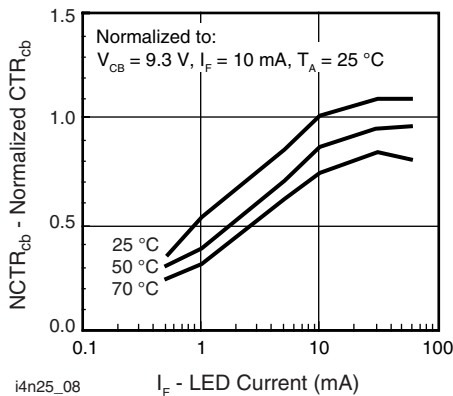

Fig. 8 - Normalized  $CTR_{cb}$  vs. LED Current and Temperature

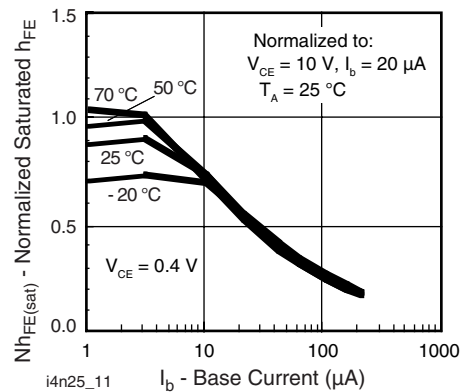

Fig. 11 - Normalized  $h_{FE}$  vs. Base Current and Temperature

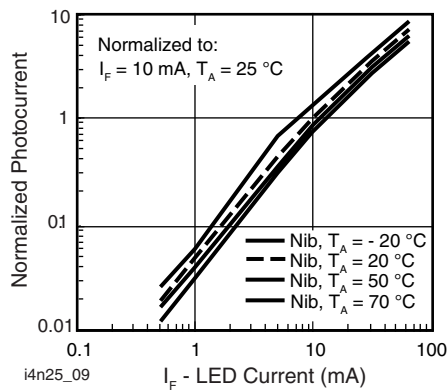

Fig. 9 - Normalized Photocurrent vs.  $I_F$  and Temperature

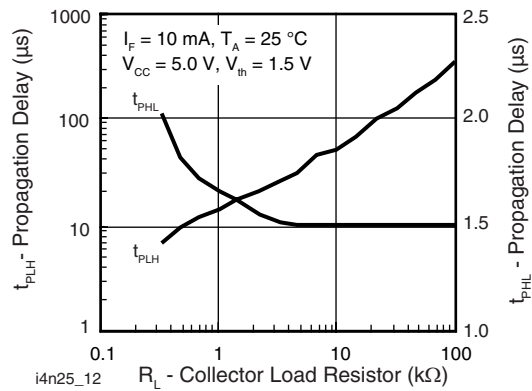
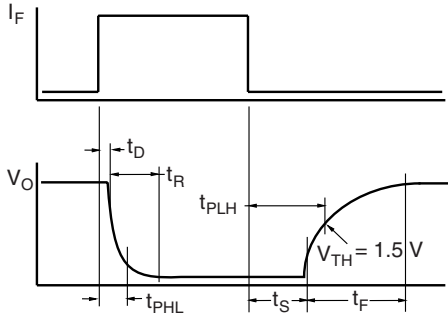

Fig. 12 - Propagation Delay vs. Collector Load Resistor

# 4N35-X, 4N36-X, 4N37-X, 4N38



Vishay Semiconductors Optocoupler, Phototransistor Output,  
with Base Connection



i4n25\_13

Fig. 13 - Switching Timing

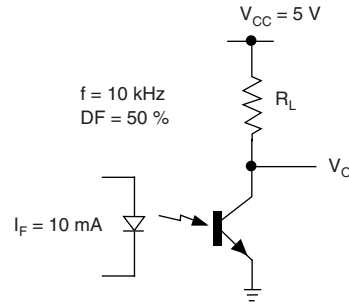

i4n25\_14

Fig. 14 - Switching Schematic

## PACKAGE DIMENSIONS in millimeters

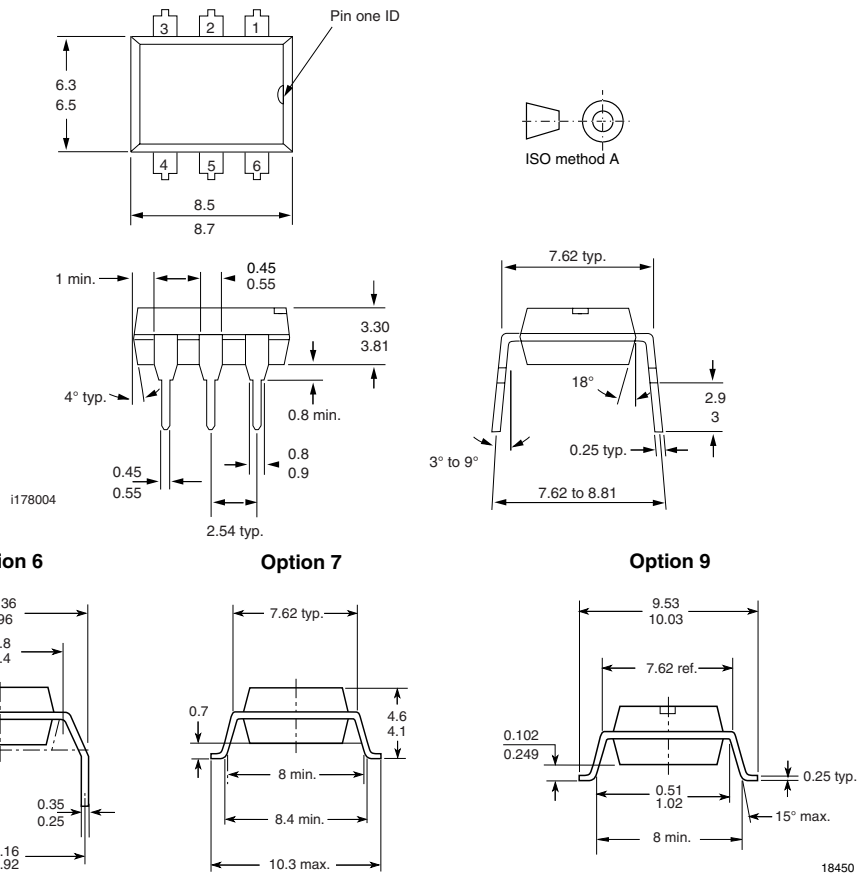

## PACKAGE MARKING

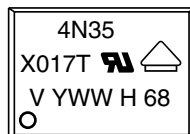

21764-23



## Disclaimer

All product specifications and data are subject to change without notice.

Vishay Intertechnology, Inc., its affiliates, agents, and employees, and all persons acting on its or their behalf (collectively, "Vishay"), disclaim any and all liability for any errors, inaccuracies or incompleteness contained herein or in any other disclosure relating to any product.

Vishay disclaims any and all liability arising out of the use or application of any product described herein or of any information provided herein to the maximum extent permitted by law. The product specifications do not expand or otherwise modify Vishay's terms and conditions of purchase, including but not limited to the warranty expressed therein, which apply to these products.

No license, express or implied, by estoppel or otherwise, to any intellectual property rights is granted by this document or by any conduct of Vishay.

The products shown herein are not designed for use in medical, life-saving, or life-sustaining applications unless otherwise expressly indicated. Customers using or selling Vishay products not expressly indicated for use in such applications do so entirely at their own risk and agree to fully indemnify Vishay for any damages arising or resulting from such use or sale. Please contact authorized Vishay personnel to obtain written terms and conditions regarding products designed for such applications.

Product names and markings noted herein may be trademarks of their respective owners.