



Is Now Part of



Datasheet.Company

**ON Semiconductor®**

To learn more about ON Semiconductor, please visit our website at  
[www.onsemi.com](http://www.onsemi.com)

ON Semiconductor and the ON Semiconductor logo are trademarks of Semiconductor Components Industries, LLC dba ON Semiconductor or its subsidiaries in the United States and/or other countries. ON Semiconductor owns the rights to a number of patents, trademarks, copyrights, trade secrets, and other intellectual property. A listing of ON Semiconductor's product/patent coverage may be accessed at [www.onsemi.com/site/pdf/Patent-Marking.pdf](http://www.onsemi.com/site/pdf/Patent-Marking.pdf). ON Semiconductor reserves the right to make changes without further notice to any products herein. ON Semiconductor makes no warranty, representation or guarantee regarding the suitability of its products for any particular purpose, nor does ON Semiconductor assume any liability arising out of the application or use of any product or circuit, and specifically disclaims any and all liability, including without limitation special, consequential or incidental damages. Buyer is responsible for its products and applications using ON Semiconductor products, including compliance with all laws, regulations and safety requirements or standards, regardless of any support or applications information provided by ON Semiconductor. "Typical" parameters which may be provided in ON Semiconductor data sheets and/or specifications can and do vary in different applications and actual performance may vary over time. All operating parameters, including "Typicals" must be validated for each customer application by customer's technical experts. ON Semiconductor does not convey any license under its patent rights nor the rights of others. ON Semiconductor products are not designed, intended, or authorized for use as a critical component in life support systems or any FDA Class 3 medical devices or medical devices with a same or similar classification in a foreign jurisdiction or any devices intended for implantation in the human body. Should Buyer purchase or use ON Semiconductor products for any such unintended or unauthorized application, Buyer shall indemnify and hold ON Semiconductor and its officers, employees, subsidiaries, affiliates, and distributors harmless against all claims, costs, damages, and expenses, and reasonable attorney fees arising out of, directly or indirectly, any claim of personal injury or death associated with such unintended or unauthorized use, even if such claim alleges that ON Semiconductor was negligent regarding the design or manufacture of the part. ON Semiconductor is an Equal Opportunity/Affirmative Action Employer. This literature is subject to all applicable copyright laws and is not for resale in any manner.



October 2015

# ES1DAF / ES1JAF Surface Mount Ultrafast Rectifier

## Features

- Fast Switching Speed – Maximum  $T_{rr}$  35 ns
  - Ultra Thin Profile - Maximum Height of 1.0 mm
  - Glass Passivated Junction
  - UL Flammability 94V-0 Classification
  - MSL 1
  - RoHS Compliant / Green Mold Compound
  - Industrial Device Qualified per AEC-Q101 Standards.
- \* see authorized use policy

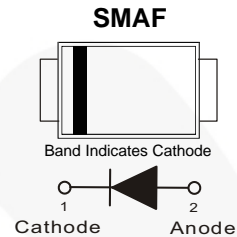

## Ordering Information

Part Number	Top Mark	Package	Packing Method
ES1DAF	ES1DAF	DO-214AD (SMAF)	Tape and Reel
ES1JAF	ES1JAF	DO-214AD (SMAF)	Tape and Reel

## Absolute Maximum Ratings

Stresses exceeding the absolute maximum ratings may damage the device. The device may not function or be operable above the recommended operating conditions and stressing the parts to these levels is not recommended. In addition, extended exposure to stresses above the recommended operating conditions may affect device reliability. The absolute maximum ratings are stress ratings only. Values are at  $T_A = 25^\circ\text{C}$  unless otherwise noted.

Symbol	Parameter	Value		Unit
		ES1DAF	ES1JAF	
$V_{RRM}$	Recurrent Peak Reverse Voltage	200	600	V
$V_{RMS}$	RMS Voltage	140	420	V
$V_R$	DC Blocking Voltage	200	600	V
$I_{F(AV)}$	Average Forward Current	1		A
$I_{FSM}$	Peak Forward Surge Current: 8.3 ms Single Half Sine-Wave Superimposed on Rated Load	30		A
$T_J$	Operating Junction Temperature Range	-55 to +150		$^\circ\text{C}$
$T_{STG}$	Storage Temperature Range	-55 to +150		$^\circ\text{C}$

ES1DAF / ES1JAF — Surface Mount Ultrafast Rectifier

## Thermal Characteristics

Values are at  $T_A = 25^\circ\text{C}$  unless otherwise noted.

Symbol	Parameter	Value	Unit
$\psi_{JL}$	Typical Thermal Characteristics, Junction-to-Lead <sup>(1)</sup>	24	$^\circ\text{C/W}$
$R_{\theta JA}$	Typical Thermal Resistance, Junction-to-Ambient <sup>(2)</sup>	150	$^\circ\text{C/W}$

### Notes:

1. Mounted on an FR4 PCB, single-sided copper, with  $48\text{cm}^2$  copper pad area.
2. Mounted on an FR4 PCB, single-sided copper, mini pad.

## Electrical Characteristics

Values are at  $T_A = 25^\circ\text{C}$  unless otherwise noted.

Symbol	Parameter	Conditions	Min.	Typ.	Max.	Unit
$V_F$	Forward Voltage	$I_F = 1\text{ A}$	ES1DAF		0.95	V
			ES1JAF		1.70	
$I_R$	Reverse Current	$V_R = V_{DC}$			1	$\mu\text{A}$
$t_{rr}$	Reverse Recovery Time	$I_F = 0.5\text{ A}$ , $I_R = 1\text{ A}$ , $I_{rr} = 0.25\text{ A}$			34	ns
$C_J$	Junction Capacitance	$V_R = 4\text{ V}$ , $f = 1\text{ MHz}$		15		pF

### Typical Performance Characteristics

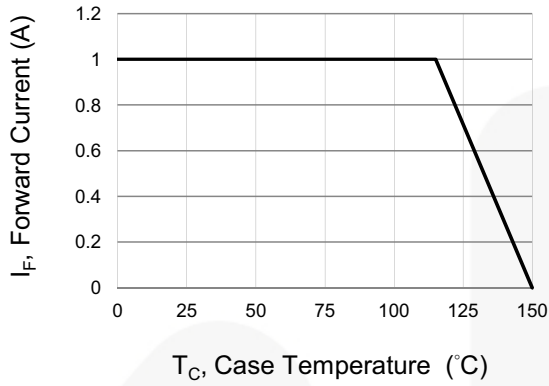

Figure 1. Forward Current Derating Curve

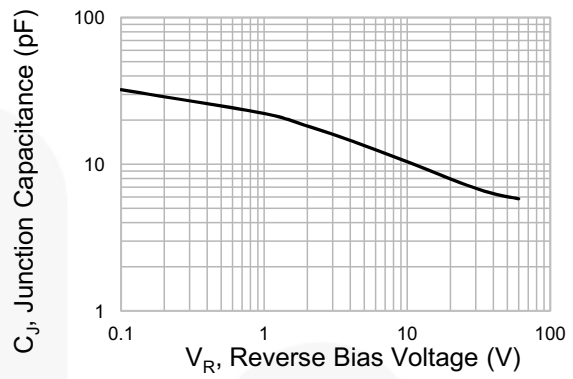

Figure 2. Typical Junction Capacitance

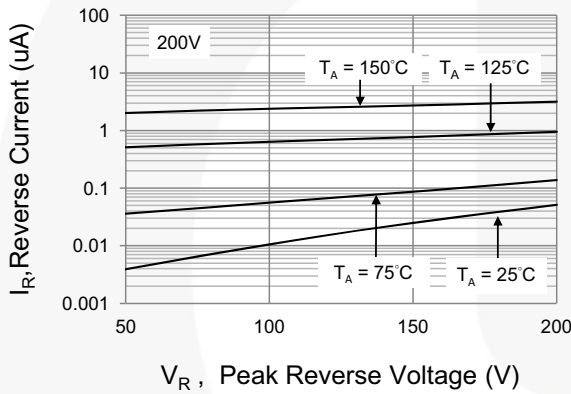

Figure 3. Typical Reverse Characteristics

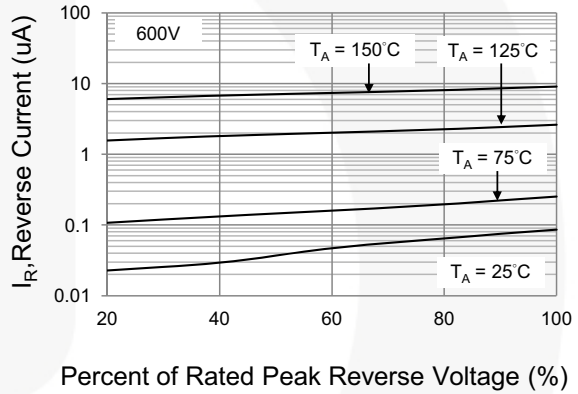

Figure 4. Typical Reverse Characteristics

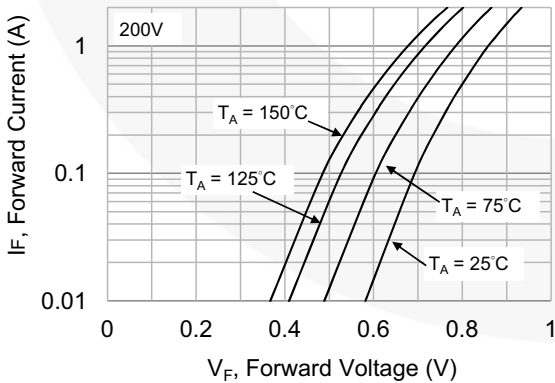

Figure 5. Typical Forward Characteristics

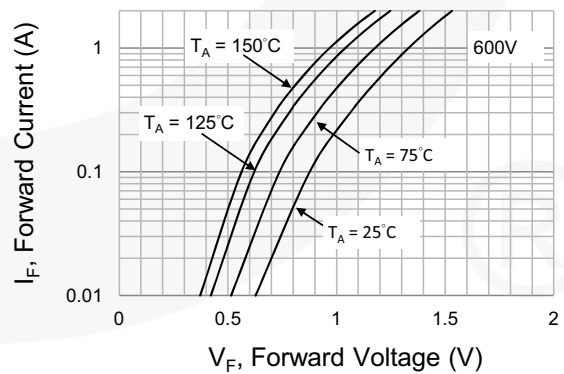
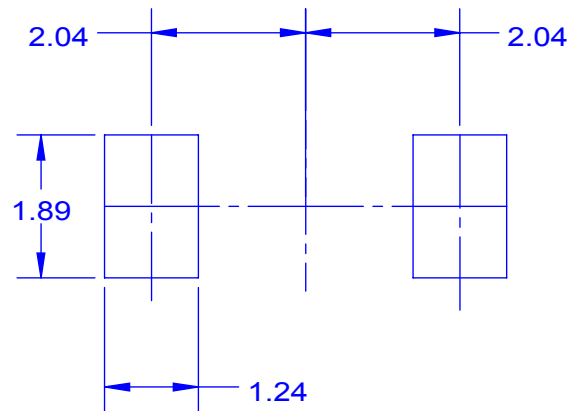
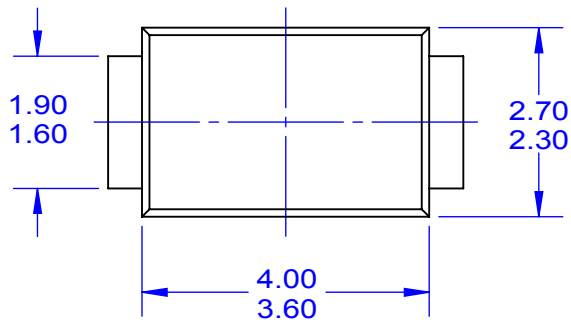
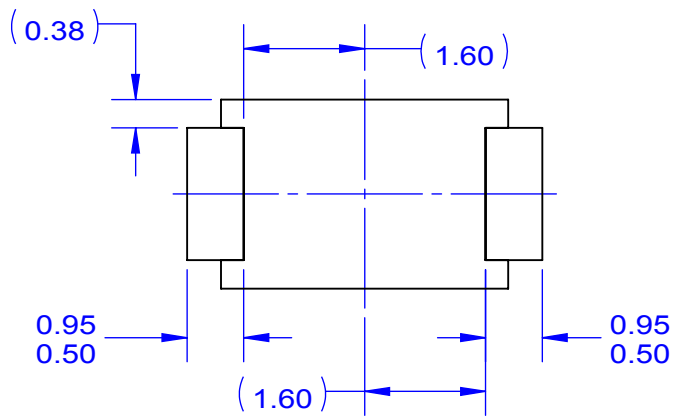
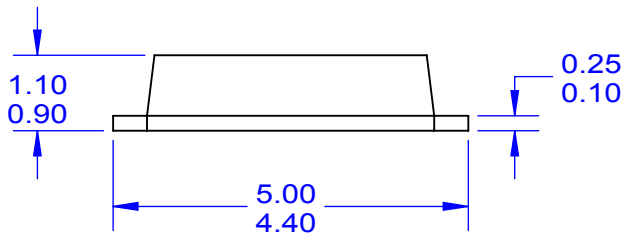

Figure 6. Typical Forward Characteristics



LAND PATTERN RECOMMENDATION



NOTES:

- A. THIS PACKAGE DOES NOT CONFORM TO ANY STANDARDS.
- B. ALL DIMENSIONS ARE IN MILLIMETERS.
- C. DIMENSIONS ARE EXCLUSIVE OF BURRS, MOLD FLASH AND TIE BAR PROTRUSIONS.
- D. LAND PATTERN RECOMMENDATION PER IPC SODFL4725X110N
- E. DRAWING FILE NAME: MKT-DO214AD REV3



ON Semiconductor and  are trademarks of Semiconductor Components Industries, LLC dba ON Semiconductor or its subsidiaries in the United States and/or other countries. ON Semiconductor owns the rights to a number of patents, trademarks, copyrights, trade secrets, and other intellectual property. A listing of ON Semiconductor's product/patent coverage may be accessed at [www.onsemi.com/site/pdf/Patent-Marking.pdf](http://www.onsemi.com/site/pdf/Patent-Marking.pdf). ON Semiconductor reserves the right to make changes without further notice to any products herein. ON Semiconductor makes no warranty, representation or guarantee regarding the suitability of its products for any particular purpose, nor does ON Semiconductor assume any liability arising out of the application or use of any product or circuit, and specifically disclaims any and all liability, including without limitation special, consequential or incidental damages. Buyer is responsible for its products and applications using ON Semiconductor products, including compliance with all laws, regulations and safety requirements or standards, regardless of any support or applications information provided by ON Semiconductor. "Typical" parameters which may be provided in ON Semiconductor data sheets and/or specifications can and do vary in different applications and actual performance may vary over time. All operating parameters, including "Typicals" must be validated for each customer application by customer's technical experts. ON Semiconductor does not convey any license under its patent rights nor the rights of others. ON Semiconductor products are not designed, intended, or authorized for use as a critical component in life support systems or any FDA Class 3 medical devices or medical devices with a same or similar classification in a foreign jurisdiction or any devices intended for implantation in the human body. Should Buyer purchase or use ON Semiconductor products for any such unintended or unauthorized application, Buyer shall indemnify and hold ON Semiconductor and its officers, employees, subsidiaries, affiliates, and distributors harmless against all claims, costs, damages, and expenses, and reasonable attorney fees arising out of, directly or indirectly, any claim of personal injury or death associated with such unintended or unauthorized use, even if such claim alleges that ON Semiconductor was negligent regarding the design or manufacture of the part. ON Semiconductor is an Equal Opportunity/Affirmative Action Employer. This literature is subject to all applicable copyright laws and is not for resale in any manner.

## PUBLICATION ORDERING INFORMATION

### LITERATURE FULFILLMENT:

Literature Distribution Center for ON Semiconductor  
19521 E. 32nd Pkwy, Aurora, Colorado 80011 USA  
**Phone:** 303-675-2175 or 800-344-3860 Toll Free USA/Canada  
**Fax:** 303-675-2176 or 800-344-3867 Toll Free USA/Canada  
**Email:** [orderlit@onsemi.com](mailto:orderlit@onsemi.com)

**N. American Technical Support:** 800-282-9855 Toll Free  
USA/Canada  
**Europe, Middle East and Africa Technical Support:**  
Phone: 421 33 790 2910  
**Japan Customer Focus Center**  
Phone: 81-3-5817-1050

**ON Semiconductor Website:** [www.onsemi.com](http://www.onsemi.com)  
**Order Literature:** <http://www.onsemi.com/orderlit>  
For additional information, please contact your local  
Sales Representative

# Mouser Electronics

Authorized Distributor

Click to View Pricing, Inventory, Delivery & Lifecycle Information:

[Fairchild Semiconductor:](#)

[ES1JAF](#)