



## N-Channel 60-V (D-S) MOSFET

PRODUCT SUMMARY				
Part Number	$V_{(BR)DSS}$ Min (V)	$r_{DS(on)}$ Max ( $\Omega$ )	$V_{GS(th)}$ (V)	$I_D$ (A)
2N7000	60	5 @ $V_{GS} = 10$ V	0.8 to 3	0.2
2N7002		7.5 @ $V_{GS} = 10$ V	1 to 2.5	0.115
VQ1000J		5.5 @ $V_{GS} = 10$ V	0.8 to 2.5	0.225
VQ1000P		5.5 @ $V_{GS} = 10$ V	0.8 to 2.5	0.225
BS170		5 @ $V_{GS} = 10$ V	0.8 to 3	0.5

### FEATURES

- Low On-Resistance: 2.5  $\Omega$
- Low Threshold: 2.1 V
- Low Input Capacitance: 22 pF
- Fast Switching Speed: 7 ns
- Low Input and Output Leakage

### BENEFITS

- Low Offset Voltage
- Low-Voltage Operation
- Easily Driven Without Buffer
- High-Speed Circuits
- Low Error Voltage

### APPLICATIONS

- Direct Logic-Level Interface: TTL/CMOS
- Drivers: Relays, Solenoids, Lamps, Hammers, Displays, Memories, Transistors, etc.
- Battery Operated Systems
- Solid-State Relays

Datasheet.Company

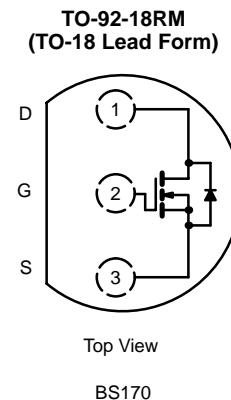
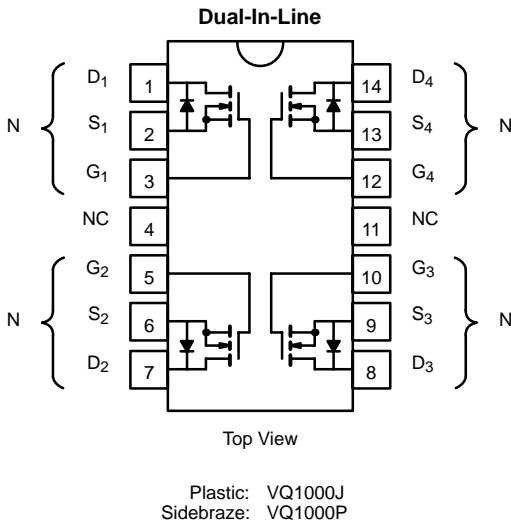
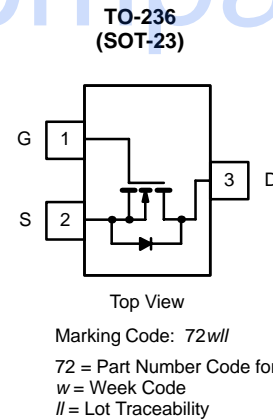
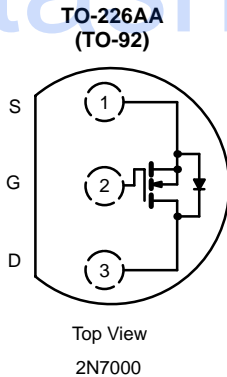



ABSOLUTE MAXIMUM RATINGS ( $T_A = 25^\circ\text{C}$ UNLESS OTHERWISE NOTED)									
Parameter	Symbol	2N7000	2N7002	Single		Total Quad	BS170	Unit	
				VQ1000J	VQ1000P	VQ1000J/P			
Drain-Source Voltage	$V_{DS}$	60	60	60	60		60	V	
Gate-Source Voltage—Non-Repetitive	$V_{GSM}$	$\pm 40$	$\pm 40$	$\pm 30$			$\pm 25$		
Gate-Source Voltage—Continuous	$V_{GS}$	$\pm 20$	$\pm 20$	$\pm 20$	$\pm 20$		$\pm 20$		
Continuous Drain Current ( $T_J = 150^\circ\text{C}$ )	$T_A = 25^\circ\text{C}$	$I_D$	0.2	0.115	0.225	0.225		0.5	A
	$T_A = 100^\circ\text{C}$		0.13	0.073	0.14	0.14		0.175	
Pulsed Drain Current <sup>a</sup>	$I_{DM}$	0.5	0.8	1	1				
Power Dissipation	$T_A = 25^\circ\text{C}$	$P_D$	0.4	0.2	1.3	1.3	2	0.83	W
	$T_A = 100^\circ\text{C}$		0.16	0.08	0.52	0.52	0.8		
Thermal Resistance, Junction-to-Ambient	$R_{thJA}$	312.5	625	96	96	62.5	156	$^\circ\text{C}/\text{W}$	
Operating Junction and Storage Temperature Range	$T_J, T_{stg}$	-55 to 150						$^\circ\text{C}$	

Notes

- a. Pulse width limited by maximum junction temperature.
- b.  $t_p \leq 50 \mu\text{s}$ .

SPECIFICATIONS—2N7000 AND 2N7002 ( $T_A = 25^\circ\text{C}$ UNLESS OTHERWISE NOTED)								
Parameter	Symbol	Test Conditions	Typ <sup>a</sup>	Limits				Unit
				2N7000		2N7002		
				Min	Max	Min	Max	
<b>Static</b>								
Drain-Source Breakdown Voltage	$V_{(BR)DSS}$	$V_{GS} = 0\text{ V}, I_D = 10 \mu\text{A}$	70	60		60		V
Gate-Threshold Voltage	$V_{GS(th)}$	$V_{DS} = V_{GS}, I_D = 1\text{ mA}$	2.1	0.8	3			
		$V_{DS} = V_{GS}, I_D = 0.25\text{ mA}$	2.0			1	2.5	
Gate-Body Leakage	$I_{GSS}$	$V_{DS} = 0\text{ V}, V_{GS} = \pm 15\text{ V}$			$\pm 10$			nA
		$V_{DS} = 0\text{ V}, V_{GS} = \pm 20\text{ V}$					$\pm 100$	
Zero Gate Voltage Drain Current	$I_{DSS}$	$V_{DS} = 48\text{ V}, V_{GS} = 0\text{ V}$			1			$\mu\text{A}$
		$T_C = 125^\circ\text{C}$			1000			
		$V_{DS} = 60\text{ V}, V_{GS} = 0\text{ V}$					1	
On-State Drain Current <sup>b</sup>	$I_{D(on)}$	$V_{DS} = 10\text{ V}, V_{GS} = 4.5\text{ V}$	0.35	0.075				A
		$V_{DS} = 7.5\text{ V}, V_{GS} = 10\text{ V}$	1			0.5		
		$V_{GS} = 4.5\text{ V}, I_D = 0.075\text{ A}$	4.5		5.3			
Drain-Source On-Resistance <sup>b</sup>	$r_{DS(on)}$	$V_{GS} = 5\text{ V}, I_D = 0.05\text{ A}$	3.2				7.5	$\Omega$
		$T_C = 125^\circ\text{C}$	5.8				13.5	
		$V_{GS} = 10\text{ V}, I_D = 0.5\text{ A}$	2.4		5		7.5	
		$T_J = 125^\circ\text{C}$	4.4		9		13.5	
Forward Transconductance <sup>b</sup>	$g_{fs}$	$V_{DS} = 10\text{ V}, I_D = 0.2\text{ A}$		100		80		mS
Common Source Output Conductance <sup>b</sup>	$g_{os}$	$V_{DS} = 5\text{ V}, I_D = 0.05\text{ A}$	0.5					
<b>Dynamic</b>								
Input Capacitance	$C_{iss}$	$V_{DS} = 25\text{ V}, V_{GS} = 0\text{ V}$ $f = 1\text{ MHz}$	22		60		50	pF
Output Capacitance	$C_{oss}$		11		25		25	
Reverse Transfer Capacitance	$C_{rss}$		2		5		5	



SPECIFICATIONS—2N7000 AND 2N7002 (T <sub>A</sub> = 25 °C UNLESS OTHERWISE NOTED)								
Parameter	Symbol	Test Conditions	Typ <sup>a</sup>	Limits				Unit
				2N7000		2N7002		
				Min	Max	Min	Max	
<b>Switching<sup>d</sup></b>								
Turn-On Time	t <sub>ON</sub>	V <sub>DD</sub> = 15 V, R <sub>L</sub> = 25 Ω I <sub>D</sub> ≅ 0.5 A, V <sub>GEN</sub> = 10 V, R <sub>G</sub> = 25 Ω	7		10			ns
Turn-Off Time	t <sub>OFF</sub>		7		10			
Turn-On Time	t <sub>ON</sub>	V <sub>DD</sub> = 30 V, R <sub>L</sub> = 150 Ω I <sub>D</sub> ≅ 0.2 A, V <sub>GEN</sub> = 10 V, R <sub>G</sub> = 25 Ω	7				20	
Turn-Off Time	t <sub>OFF</sub>		11				20	

SPECIFICATIONS—VQ1000J/P AND BS170 (T <sub>A</sub> = 25 °C UNLESS OTHERWISE NOTED)								
Parameter	Symbol	Test Conditions	Typ <sup>a</sup>	Limits				Unit
				VQ1000J/P		BS170		
				Min	Max	Min	Max	
<b>Static</b>								
Drain-Source Breakdown Voltage	V <sub>(BR)DSS</sub>	V <sub>GS</sub> = 0 V, I <sub>D</sub> = 100 μA	70	60		60		V
Gate-Threshold Voltage	V <sub>GS(th)</sub>	V <sub>DS</sub> = V <sub>GS</sub> , I <sub>D</sub> = 1 mA	2.1	0.8	2.5	0.8	3	
Gate-Body Leakage	I <sub>GSS</sub>	V <sub>DS</sub> = 0 V, V <sub>GS</sub> = ±10 V			±100			nA
		T <sub>J</sub> = 125 °C			±500			
Zero Gate Voltage Drain Current	I <sub>DSS</sub>	V <sub>DS</sub> = 0 V, V <sub>GS</sub> = ±15 V					±10	μA
		V <sub>DS</sub> = 25 V, V <sub>GS</sub> = 0 V					0.5	
		V <sub>DS</sub> = 48 V, V <sub>GS</sub> = 0 V, T <sub>J</sub> = 125 °C			500			
On-State Drain Current <sup>b</sup>	I <sub>D(on)</sub>	V <sub>DS</sub> = 10 V, V <sub>GS</sub> = 10 V	1	0.5				A
		V <sub>GS</sub> = 5 V, I <sub>D</sub> = 0.2 A	4		7.5			
Drain-Source On-Resistance <sup>b</sup>	r <sub>DS(on)</sub>	V <sub>GS</sub> = 10 V, I <sub>D</sub> = 0.2 A	2.3				5	Ω
		V <sub>GS</sub> = 10 V, I <sub>D</sub> = 0.3 A	2.3		5.5			
		T <sub>J</sub> = 125 °C	4.2		7.6			
		V <sub>DS</sub> = 10 V, I <sub>D</sub> = 0.2 A				100		
Forward Transconductance <sup>b</sup>	g <sub>fs</sub>	V <sub>DS</sub> = 10 V, I <sub>D</sub> = 0.5 A		100				mS
Common Source Output Conductance <sup>b</sup>	g <sub>os</sub>	V <sub>DS</sub> = 5 V, I <sub>D</sub> = 0.05 A	0.5					
<b>Dynamic</b>								
Input Capacitance	C <sub>iSS</sub>	V <sub>DS</sub> = 25 V, V <sub>GS</sub> = 0 V f = 1 MHz	22		60		60	pF
Output Capacitance	C <sub>oss</sub>		11		25			
Reverse Transfer Capacitance	C <sub>rSS</sub>		2		5			
<b>Switching<sup>d</sup></b>								
Turn-On Time	t <sub>ON</sub>	V <sub>DD</sub> = 15 V, R <sub>L</sub> = 23 Ω I <sub>D</sub> ≅ 0.6 A, V <sub>GEN</sub> = 10 V, R <sub>G</sub> = 25 Ω	7		10			ns
Turn-Off Time	t <sub>OFF</sub>		7		10			
Turn-On Time	t <sub>ON</sub>	V <sub>DD</sub> = 25 V, R <sub>L</sub> = 125 Ω I <sub>D</sub> ≅ 0.2 A, V <sub>GEN</sub> = 10 V, R <sub>G</sub> = 25 Ω	7				10	
Turn-Off Time	t <sub>OFF</sub>		7				10	

Notes

- a. For DESIGN AID ONLY, not subject to production testing.
- b. Pulse test: PW ≤ 80 μs duty cycle ≤ 1%.
- c. This parameter not registered with JEDEC.
- d. Switching time is essentially independent of operating temperature.

VNBF06

**TYPICAL CHARACTERISTICS ( $T_A = 25^\circ\text{C}$  UNLESS OTHERWISE NOTED)**

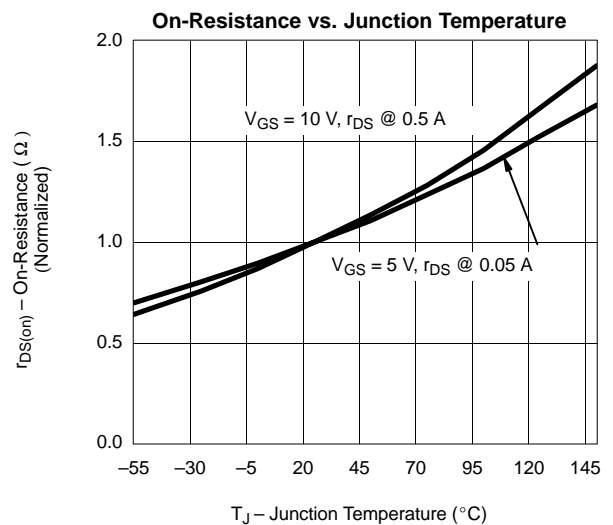
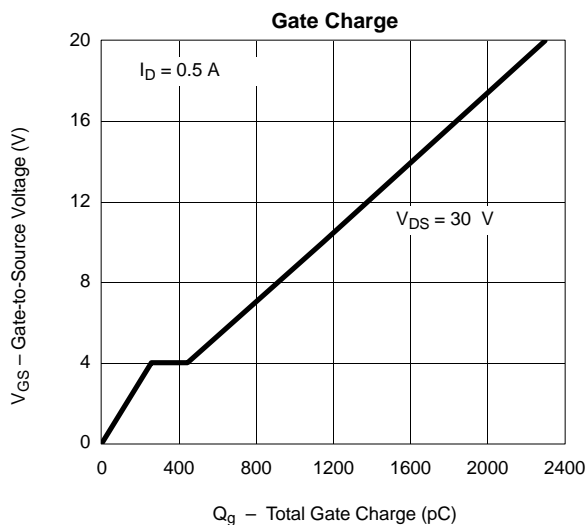
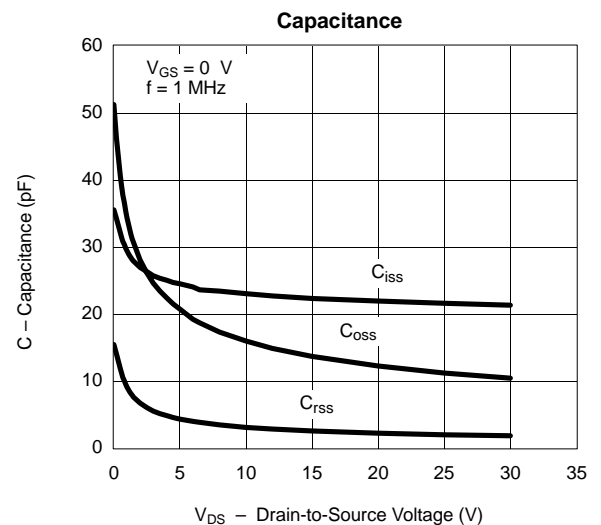
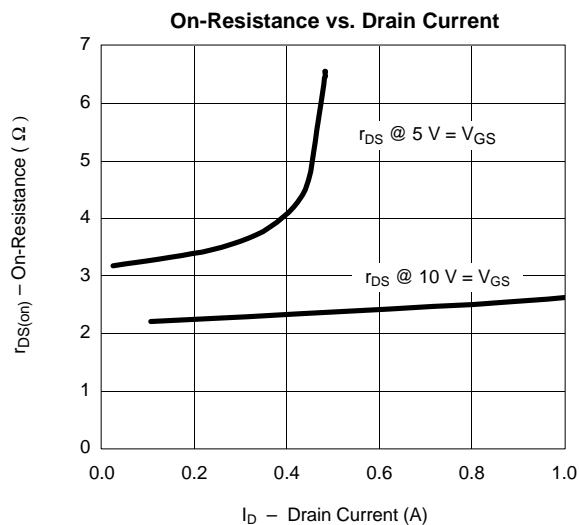
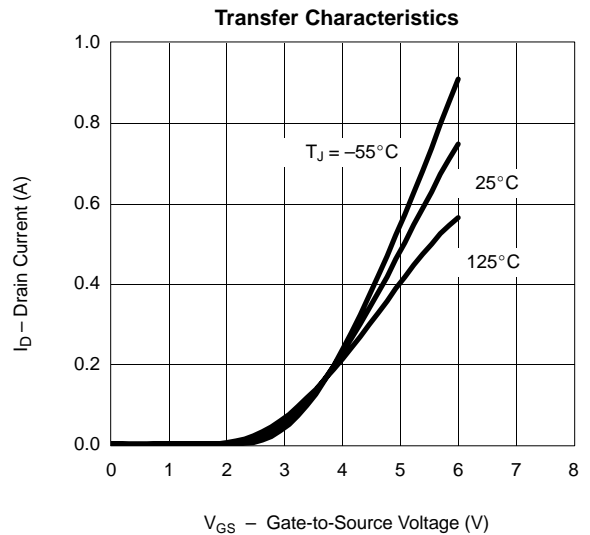
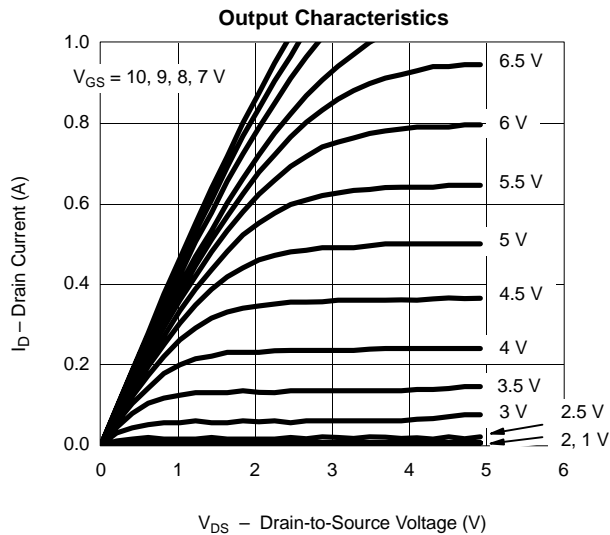



**TYPICAL CHARACTERISTICS ( $T_A = 25^\circ\text{C}$  UNLESS OTHERWISE NOTED)**

