

High voltage ultrafast diode

Main product characteristics

$I_{F(AV)}$	2 A
V_{RRM}	1200 V
T_j	175°C
V_F (typ)	1.0 V
t_{rr} (max)	75 ns

Features and benefits

- Low forward voltage drop
- High reliability
- High surge current capability
- Soft switching for reduced EMI disturbances
- Planar technology

Description

The STTH212, which is using ST ultrafast high voltage planar technology, is specially suited for free-wheeling, clamping, snubbing, demagnetization in power supplies and other power switching applications.

Housed in axial, SMB, and SMC packages, this diode will reduce the losses in high switching frequency operations.

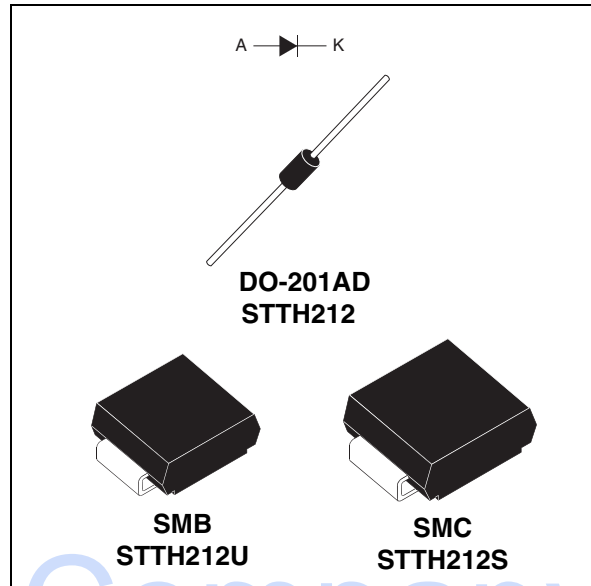

Order codes

Part Number	Marking
STTH212	STTH212
STTH212RL	STTH212
STTH212U	U22
STTH212S	S12

1 Electrical characteristics

Table 1. Absolute Ratings (limiting values)

Symbol	Parameter		Value	Unit	
V_{RRM}	Repetitive peak reverse voltage		1200	V	
$V_{(RMS)}$	RMS voltage		850	V	
$I_{F(AV)}$	Average forward current $\delta = 0.5$	DO-201AD	$T_1 = 105^\circ\text{C}$	2	A
		SMB	$T_1 = 90^\circ\text{C}$		
		SMC	$T_1 = 105^\circ\text{C}$		
$I_{F(RMS)}$	RMS forward current	DO-201AD, SMB, SMC		10	A
I_{FSM}	Forward surge current $t_p = 8.3\text{ms}$	DO-201AD, SMB, SMC		40	A
T_{stg}	Storage temperature range		-50 to + 175	$^\circ\text{C}$	
T_j	Maximum operating junction temperature		175	$^\circ\text{C}$	

Table 2. Thermal parameters

Symbol	Parameter		Value	Unit	
$R_{th(j-l)}$	Junction to lead	L = 10 mm	DO-201AD	20	$^\circ\text{C/W}$
			SMB	25	
			SMC	20	
$R_{th(j-a)}$	Junction to ambient	L = 10 mm	DO-201AD	75	$^\circ\text{C/W}$

Table 3. Static Electrical Characteristics

Symbol	Parameter	Test conditions		Min.	Typ	Max.	Unit
I_R	Reverse leakage current	$T_j = 25^\circ\text{C}$	$V_R = V_{RRM}$			10	μA
		$T_j = 125^\circ\text{C}$				100	
V_F	Forward voltage drop	$T_j = 25^\circ\text{C}$	$I_F = 2\text{A}$			1.75	V
		$T_j = 125^\circ\text{C}$			1.07	1.50	
		$T_j = 150^\circ\text{C}$			1.0	-	

To evaluate the conduction losses use the following equation: $P = 1.26 \times I_{F(AV)} + 0.12 I_{F(RMS)}^2$

Table 4. Dynamic Electrical Characteristics

Symbol	Parameter	Test conditions		Min.	Typ	Max.	Unit
t_{rr}	Reverse recovery time	$T_j = 25^\circ\text{C}$	$I_F = 1\text{A}$ $di_F/dt = -100\text{ A}/\mu\text{s}$ $V_R = 30\text{V}$			75	ns
t_{fr}	Forward recovery time	$T_j = 25^\circ\text{C}$	$I_F = 2\text{A}$ $di_F/dt = 50\text{ A}/\mu\text{s}$ $V_{FR} = 1.1 \times V_{Fmax}$			500	ns
V_{FP}	Forward recovery voltage					30	V

Figure 1. Conduction losses versus average forward current

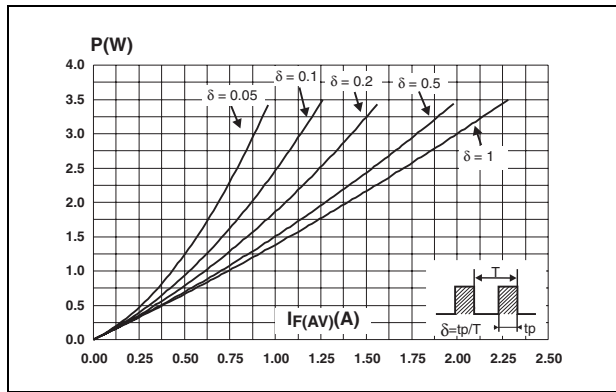

Figure 2. Forward voltage drop versus forward current

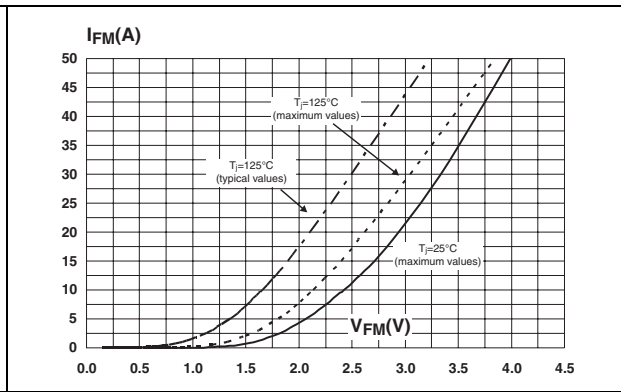

Figure 3. Relative variation of thermal impedance junction to ambient versus pulse duration (Epoxy printed circuit board FR4, $L_{Leads} = 10\text{mm}$)

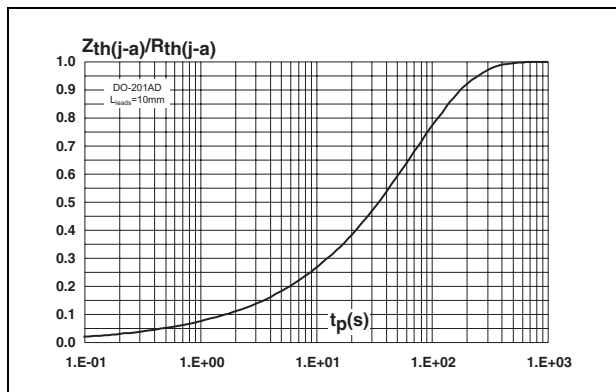

Figure 4. Relative variation of thermal impedance junction to ambient versus pulse duration (Epoxy printed circuit board FR4, $S_{CU} = 1\text{cm}^2$)

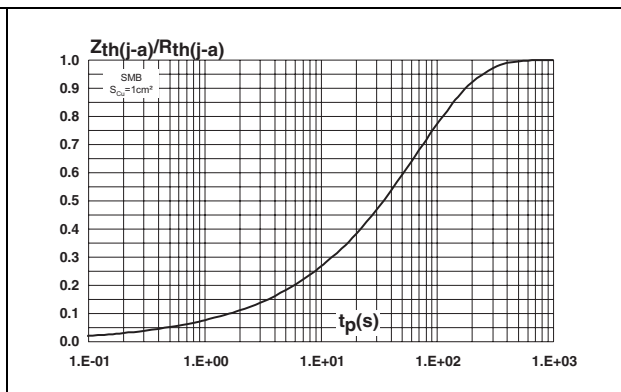

Figure 5. Relative variation of thermal impedance junction to ambient versus pulse duration (Epoxy printed circuit board FR4, $S_{CU} = 1\text{cm}^2$)

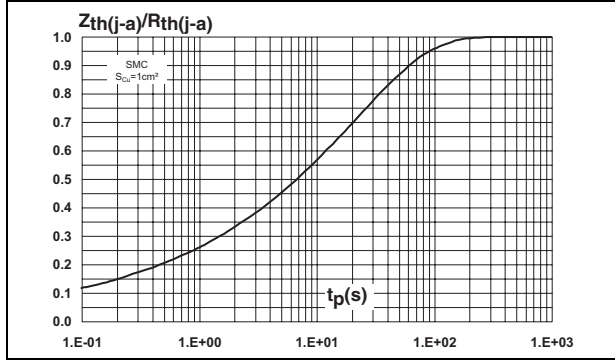

Figure 6. Reverse recovery current versus di_F/dt (typical values)

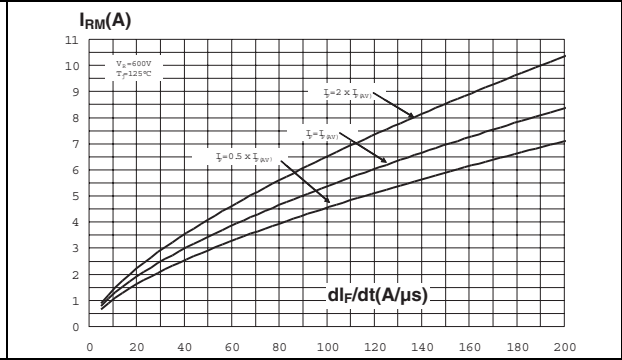

Figure 7. Reverse recovery time versus di_F/dt (typical values)

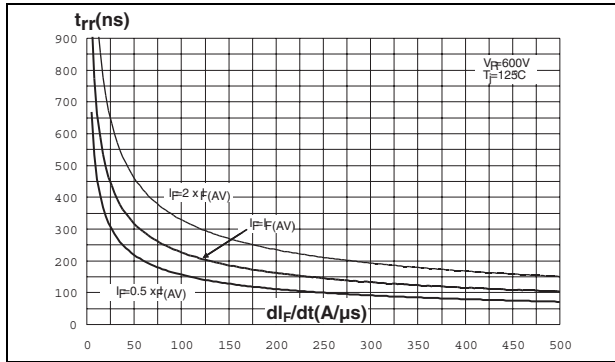

Figure 8. Reverse recovery charges versus di_F/dt (typical values)

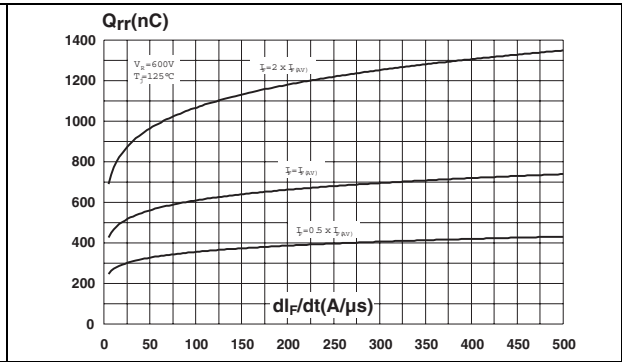

Figure 9. Softness factor versus di_F/dt (typical values)

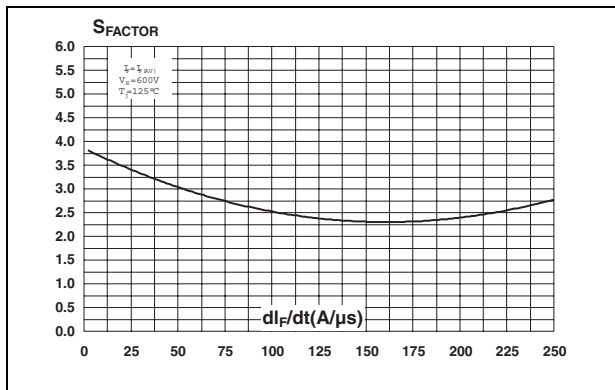

Figure 10. Relative variations of dynamic parameters versus junction temperature

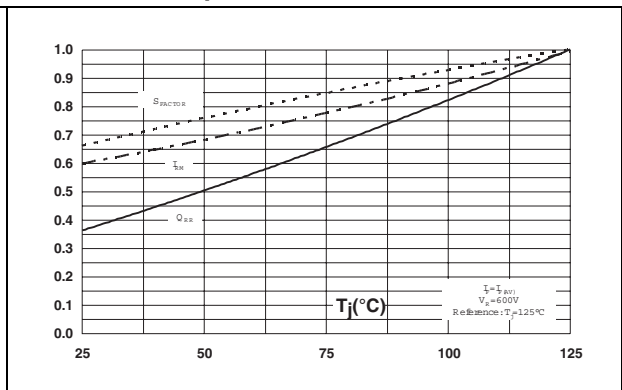

Figure 11. Transient peak forward voltage versus di_F/dt (typical values)

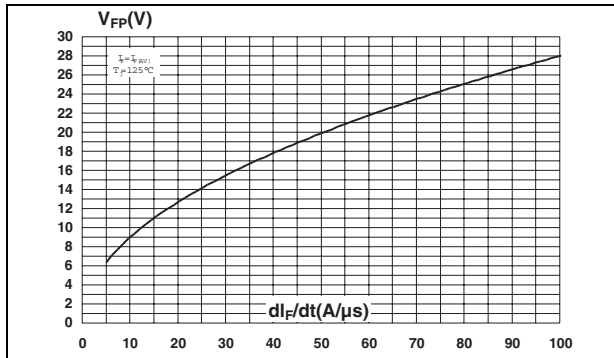

Figure 12. Forward recovery time versus di_F/dt (typical values)

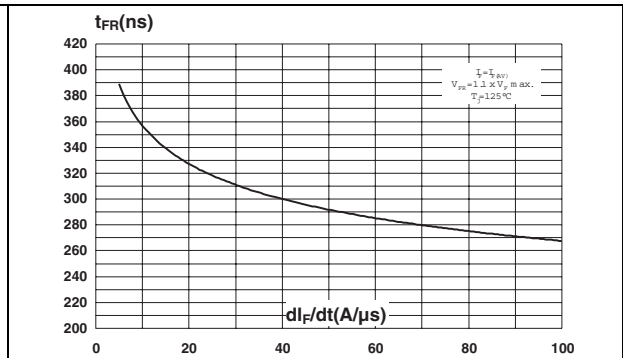

Figure 13. Junction capacitance versus reverse voltage applied (typical values)

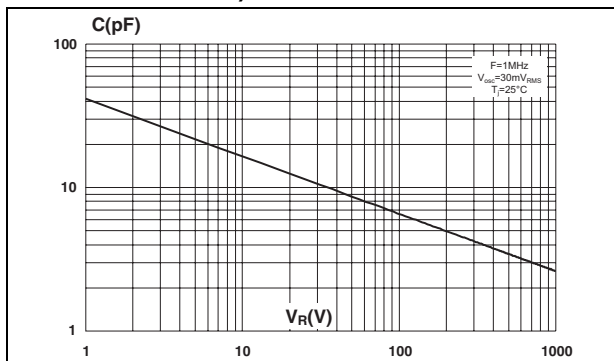

Figure 14. Thermal resistance versus lead length

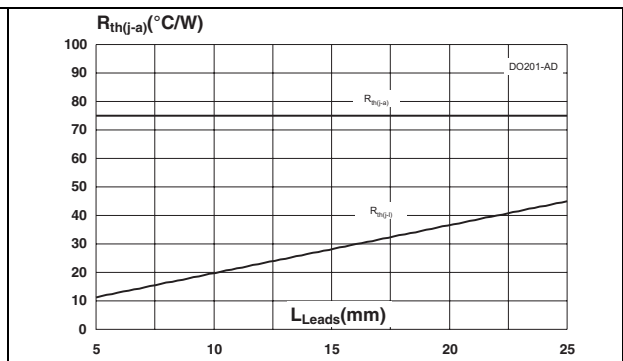

Figure 15. Thermal resistance junction to ambient versus copper surface under each lead (Epoxy printed circuit board FR4, $e_{Cu} = 35\mu m$)

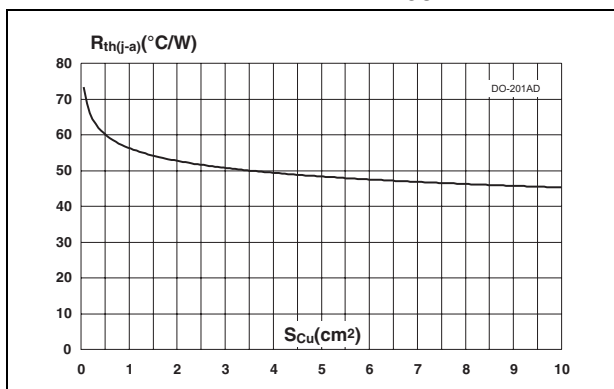
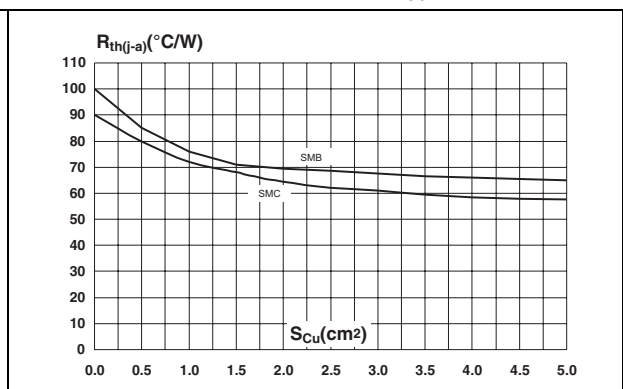

Figure 16. Thermal resistance junction to ambient versus copper surface under each lead (Epoxy printed circuit board FR4, $e_{Cu} = 35\mu m$)



2 Package mechanical data

Table 5. SMB dimensions

REF.	DIMENSIONS			
	Millimeters		Inches	
	Min.	Max.	Min.	Max.
A1	1.90	2.45	0.075	0.096
A2	0.05	0.20	0.002	0.008
b	1.95	2.20	0.077	0.087
c	0.15	0.41	0.006	0.016
E	5.10	5.60	0.201	0.220
E1	4.05	4.60	0.159	0.181
D	3.30	3.95	0.130	0.156
L	0.75	1.60	0.030	0.063

Figure 17. SMB references to dimensions table **Figure 18. SMB footprint dimensions (in millimetres)**

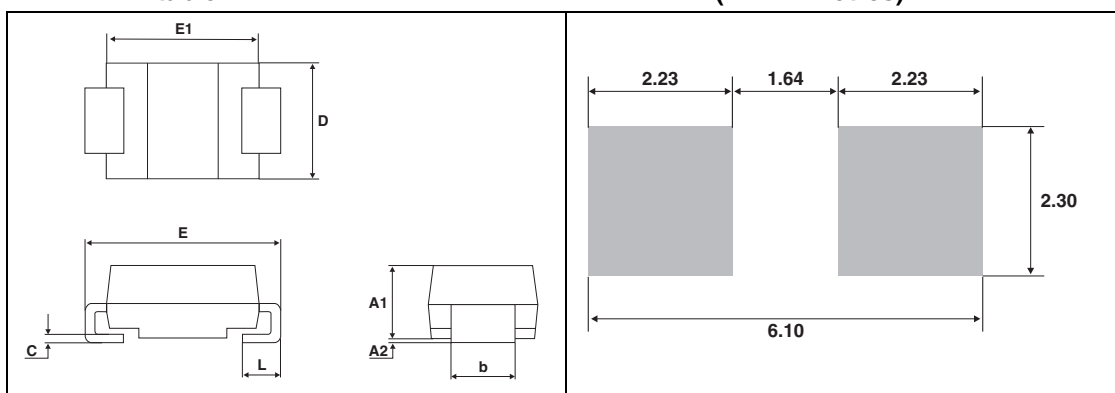

Table 6. SMC dimensions

REF.	DIMENSIONS			
	Millimeters		Inches	
	Min.	Max.	Min.	Max.
A1	1.90	2.45	0.075	0.096
A2	0.05	0.20	0.002	0.008
b	2.90	3.2	0.114	0.126
c	0.15	0.41	0.006	0.016
E	7.75	8.15	0.305	0.321
E1	6.60	7.15	0.260	0.281
E2	4.40	4.70	0.173	0.185
D	5.55	6.25	0.218	0.246
L	0.75	1.60	0.030	0.063

Figure 19. SMC references to dimensions table **Figure 20. SMC footprint dimensions (in millimetres)**

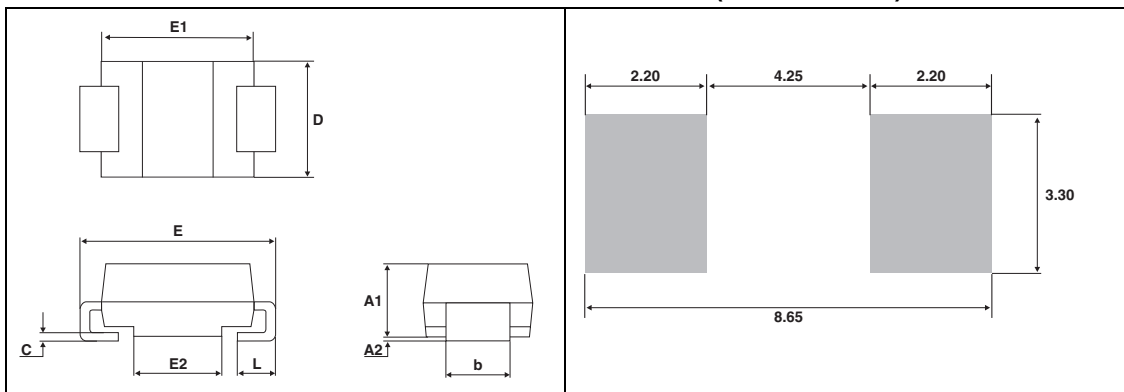

Table 7. DO-201AD dimensions

REF.	DIMENSIONS			
	Millimeters		Inches	
	Min.	Max.	Min.	Max.
A	-	9.5	-	0.37
B	25.4	-	1.00	-
C	-	5.3	-	0.21
D	-	1.3	-	0.051
E	-	1.25	-	0.048

Note: 1 The lead diameter D is not controlled over zone E .

2 The minimum length which must stay straight between the right angles after bending is 15 mm (0.59 inch).

3 Ordering information

Part Number	Marking	Package	Weight	Base qty	Delivery mode
STTH212	STTH212	DO-201AD	1.12 g	600	Ammopack
STTH212RL	STTH212			1900	Tape & reel
STTH212U	U22	SMB	0.11 g	2500	Tape & reel
STTH212S	S12	SMC	0.243 g	2500	Tape & reel

4 Revision history

Date	Revision	Description of Changes
28-Jun-2005	1	First issue.

Information furnished is believed to be accurate and reliable. However, STMicroelectronics assumes no responsibility for the consequences of use of such information nor for any infringement of patents or other rights of third parties which may result from its use. No license is granted by implication or otherwise under any patent or patent rights of STMicroelectronics. Specifications mentioned in this publication are subject to change without notice. This publication supersedes and replaces all information previously supplied. STMicroelectronics products are not authorized for use as critical components in life support devices or systems without express written approval of STMicroelectronics.

The ST logo is a registered trademark of STMicroelectronics.
All other names are the property of their respective owners

© 2005 STMicroelectronics - All rights reserved

STMicroelectronics group of companies

Australia - Belgium - Brazil - Canada - China - Czech Republic - Finland - France - Germany - Hong Kong - India - Israel - Italy - Japan -
Malaysia - Malta - Morocco - Singapore - Spain - Sweden - Switzerland - United Kingdom - United States of America

www.st.com



Mouser Electronics

Authorized Distributor

Click to View Pricing, Inventory, Delivery & Lifecycle Information:

[STMicroelectronics:](#)

[STTH212S](#) [STTH212U](#)