

Type DCMC 85 °C High Capacitance, Screw Terminal, Aluminum

Highest Capacitance Screw Terminal Type



With more capacitance and often more ripple-current capability than the best-value Type 3186 capacitor, the Type DCMC capacitor is the better choice for high-capacitance, power supply filters and energy storage applications such as welding equipment, UPS systems and computer hold-up power. The extended cathode foil of the DCMC assures cool operation with heatflow from the capacitor element to the can.

Highlights

- Highest capacitance value
- Right for Power Supply and UPS systems
- Thermal-Pak™ extended cathode construction

Specifications

| | | | | | | | | |
|---|---|-------|-------|--------|--------|-------|-------|-------------|
| Temperature Range | -40 °C to +85 °C | | | | | | | |
| Rated Voltage Range | 6.3 Vdc to 550 Vdc | | | | | | | |
| Capacitance Range | 110 µF to 2.7 F | | | | | | | |
| Capacitance Tolerance | -10% +75% ≤ 100 Vdc -10% +50% ≥ 160 Vdc | | | | | | | |
| Leakage Current | ≤ 6 \sqrt{CV} µA, 6 mA max, at 5 min | | | | | | | |
| Ripple Current Multipliers | Ambient Temperature | | | | | | | |
| | | 45 °C | 55 °C | 65 °C | 75 °C | 85 °C | | |
| | | 2.24 | 2.00 | 1.73 | 1.41 | 1.00 | | |
| | Frequency | | | | | | | |
| | | 50 Hz | 60 Hz | 120 Hz | 360 Hz | 1 kHz | 5 kHz | 10 kHz & up |
| | 1 3/8" & 1 3/4" Diameters 6.3 to 160 V 200 to 350 V 400 to 550 V | 0.92 | 0.94 | 1.00 | 1.05 | 1.10 | 1.10 | 1.12 |
| | | 0.80 | 0.85 | 1.00 | 1.17 | 1.30 | 1.30 | 1.32 |
| | | 0.78 | 0.83 | 1.00 | 1.20 | 1.35 | 1.36 | 1.40 |
| | 2" & 2 1/2" Diameters 6.3 to 160 V 200 to 350 V 400 to 550 V | 0.93 | 0.95 | 1.00 | 1.04 | 1.07 | 1.11 | 1.12 |
| | | 0.81 | 0.87 | 1.00 | 1.13 | 1.20 | 1.24 | 1.26 |
| 0.79 | | 0.83 | 1.00 | 1.17 | 1.26 | 1.30 | 1.34 | |
| 3" & 3 1/2" Diameters 6.3 to 160 V 200 to 350 V 400 to 550 V | 0.95 | 0.96 | 1.00 | 1.02 | 1.04 | 1.05 | 1.05 | |
| | 0.85 | 0.88 | 1.00 | 1.08 | 1.12 | 1.14 | 1.17 | |
| | 0.82 | 0.84 | 1.00 | 1.13 | 1.20 | 1.24 | 1.27 | |
| Low Temperature Characteristics | Impedance ratio: $Z_{-20^{\circ}\text{C}}/Z_{+25^{\circ}\text{C}}$ ≤ 20 (6.3–10 Vdc) ≤ 8 (16–50 Vdc) ≤ 4 (63–100 Vdc) ≤ 3 (150–550 Vdc) | | | | | | | |
| Endurance Life Test | 2000 h @ full load at 85 °C Δ Capacitance ±20% ESR 200% of limit DCL 100% of limit | | | | | | | |
| Shelf Life Test | 500 h @ 85 °C Capacitance 100% of limit ESR 100% of limit DCL 100% of limit | | | | | | | |
| Vibration | 5 to 55 Hz, 0.06" and 10 g max, 1.5 h each of 2 axes | | | | | | | |
| RoHS Compliant | | | | | | | | |

Type DCMC 85 °C High Capacitance, Screw Terminal, Aluminum

Highest Capacitance Screw Terminal Type

Part Numbering System

| DCMC | 472 | U | 400 | DC | 2 | B | S |
|--------------------|----------------------|------------------|----------------|------------------|-------------------|-----------------------------|---------------------------|
| Type | Capacitance | Tolerance | Voltage | Case Code | Insulation | Terminal | Can Style |
| 100 = 10 μ F | 101 = 100 μ F | M = \pm 20% | 6R3 = 6.3 Vdc | 0 = None | 0 = None | A = Low Post | Blank = Standard Can |
| 492 = 4900 μ F | 433 = 43,000 μ F | U = -10%+75% | 063 = 63 Vdc | 1 = Polyester | 1 = Polyester | D = High Current, Low Post | S = Stud Bottom |
| | | T = 10%+50% | 400 = 400 Vdc | 2 = PVC | 2 = PVC | E = High Current, High Post | P = Stud with Thermal Pad |
| | | | | | | F or M = M5 Post | |
| | | | | | | G = M6 Low Post | |
| | | | | | | H = M6 High Post | |

Polyester insulation is not available for 3.5-inch diameter units.
Standard insulation is 0.008-in PVC sleeve with 0.01-in polypropylene end disk.

Outline Drawing

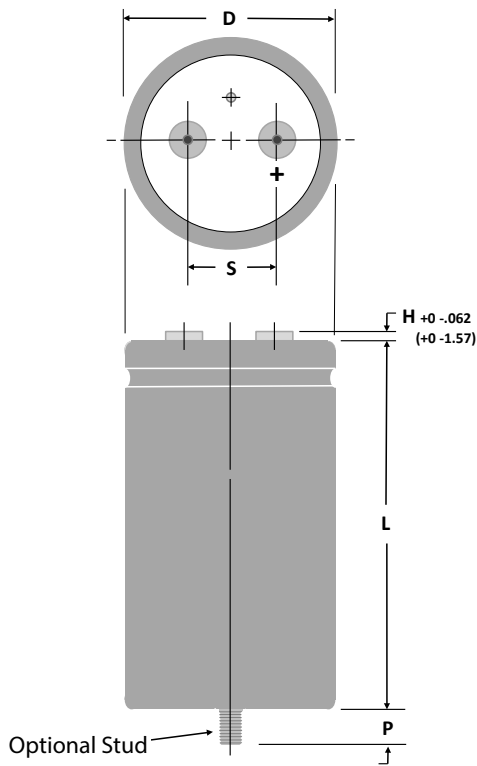

Stud Dimensions

| Case Diam. | Stud Thread | P \pm 0.039" (\pm 1.0 mm) |
|------------|-------------|--------------------------------|
| 1.375 | M8 | 0.470" (12.0) |
| 1.750 | M8 | 0.470" (12.0) |
| 2.000 | M12 | 0.630" (16.0) |
| 2.500 | M12 | 0.630" (16.0) |
| 3.000 | M12 | 0.630" (16.0) |
| 3.500 | M12 | 0.630" (16.0) |

NOTE: With the stud-mount feature, a thermally-conductive disk can be inserted in the bottom flush with the outer insulating sleeve. This reduces the thermal resistance through the can bottom by 0.3 °C/W. Can Style P.

Terminal Dimensions

| Terminal Style | For Case | | Post Diameter | | H max | | Thread | min Full Thread | | Torque | |
|--------------------|------------------------------------|------|---------------|------|-------|-----|--------|-----------------|------|--------|------|
| | Diameters | Code | in | mm | in | mm | | in | mm | in-lb | N-m |
| Low Post | 1 $\frac{3}{8}$ to 3 | A | 0.314 | 8.0 | 0.094 | 2.4 | 10-32 | 0.218 | 5.5 | 25 | 2.82 |
| High Post | 1 $\frac{3}{8}$ to 3 | B | 0.314 | 8.0 | 0.281 | 7.1 | 10-32 | 0.375 | 9.5 | 25 | 2.82 |
| High Current, Low | 2 $\frac{1}{2}$ to 3 $\frac{1}{2}$ | D | 0.684 | 17.4 | 0.125 | 3.2 | ¼-28 | 0.344 | 8.7 | 60 | 6.78 |
| High Current, High | 2 $\frac{1}{2}$ to 3 $\frac{1}{2}$ | E | 0.684 | 17.4 | 0.281 | 7.1 | ¼-28 | 0.469 | 11.9 | 60 | 6.78 |
| M5 Post, Small | 1 $\frac{3}{8}$ to 2 | M | 0.314 | 8.0 | 0.281 | 7.1 | M5 | 0.375 | 9.5 | 25 | 2.82 |
| M5 Post | 2 $\frac{1}{2}$ & 3 | F | 0.512 | 13.0 | 0.230 | 5.8 | M5 | 0.344 | 8.7 | 25 | 2.82 |
| M6 Low Post | 2 $\frac{1}{2}$ to 3 $\frac{1}{2}$ | G | 0.684 | 17.4 | 0.125 | 3.2 | M6 | 0.344 | 8.7 | 60 | 6.78 |
| M6 High Post | 2 $\frac{1}{2}$ to 3 $\frac{1}{2}$ | H | 0.684 | 17.4 | 0.281 | 7.1 | M6 | 0.469 | 11.9 | 60 | 6.78 |

NOTE: Only high post and M5 post terminals are available at 550 Vdc as they meet the required creepage distance.

Type DCMC 85 °C High Capacitance, Screw Terminal, Aluminum

Highest Capacitance Screw Terminal Type

Uninsulated Case Dimensions

For insulated case, add 0.024"(0.610 mm) to "D" and 0.030"(0.762 mm) to height.

| Case Code | Diam. (D) | | Length (L) | | Terminals (S) | | Typical Weight | |
|-----------|--------------|---------|--------------|----------|---------------|---------|----------------|------|
| | ±.031 Inches | ±.78 mm | ±.062 Inches | ±1.57 mm | ±0.015 Inches | ±.38 mm | oz | g |
| AK | 1.375 | 34.93 | 1.625 | 41.28 | 0.50 | 12.70 | 1.9 | 54 |
| AA | 1.375 | 34.93 | 2.125 | 53.98 | 0.50 | 12.70 | 2.0 | 57 |
| AH | 1.375 | 34.93 | 2.625 | 66.68 | 0.50 | 12.70 | 2.7 | 77 |
| AB | 1.375 | 34.93 | 3.125 | 79.38 | 0.50 | 12.70 | 3.3 | 94 |
| AJ | 1.375 | 34.93 | 3.625 | 92.08 | 0.50 | 12.70 | 3.8 | 108 |
| AC | 1.375 | 34.93 | 4.125 | 104.78 | 0.50 | 12.70 | 4.4 | 125 |
| AD | 1.375 | 34.93 | 4.625 | 117.48 | 0.50 | 12.70 | 5.1 | 145 |
| AE | 1.375 | 34.93 | 5.125 | 130.18 | 0.50 | 12.70 | 6.8 | 193 |
| AF | 1.375 | 34.93 | 5.625 | 142.88 | 0.50 | 12.70 | 8.1 | 230 |
| EA | 1.750 | 44.45 | 2.125 | 53.98 | 0.75 | 19.05 | 2.7 | 76 |
| EH | 1.750 | 44.45 | 2.625 | 66.68 | 0.75 | 19.05 | 3.8 | 108 |
| EB | 1.750 | 44.45 | 3.125 | 79.38 | 0.75 | 19.05 | 5.1 | 145 |
| EJ | 1.750 | 44.45 | 3.625 | 92.08 | 0.75 | 19.05 | 6.8 | 193 |
| EC | 1.750 | 44.45 | 4.125 | 104.78 | 0.75 | 19.05 | 8.1 | 230 |
| ED | 1.750 | 44.45 | 4.625 | 117.48 | 0.75 | 19.05 | 9.0 | 255 |
| EE | 1.750 | 44.45 | 5.125 | 130.18 | 0.75 | 19.05 | 9.5 | 269 |
| EF | 1.750 | 44.45 | 5.625 | 142.88 | 0.75 | 19.05 | 10.5 | 298 |
| BA | 2.000 | 50.80 | 2.125 | 53.98 | 0.88 | 22.23 | 5.4 | 153 |
| BH | 2.000 | 50.80 | 2.625 | 66.68 | 0.88 | 22.23 | 6.1 | 173 |
| BB | 2.000 | 50.80 | 3.125 | 79.38 | 0.88 | 22.23 | 6.8 | 193 |
| BJ | 2.000 | 50.80 | 3.625 | 92.08 | 0.88 | 22.23 | 8.2 | 232 |
| BC | 2.000 | 50.80 | 4.125 | 104.78 | 0.88 | 22.23 | 9.5 | 269 |
| BD | 2.000 | 50.80 | 4.625 | 117.48 | 0.88 | 22.23 | 10.3 | 292 |
| BE | 2.000 | 50.80 | 5.125 | 130.18 | 0.88 | 22.23 | 10.7 | 303 |
| BF | 2.000 | 50.80 | 5.625 | 142.88 | 0.88 | 22.23 | 13.0 | 369 |
| CH | 2.500 | 63.50 | 2.625 | 66.68 | 1.13 | 28.58 | 9.2 | 261 |
| CB | 2.500 | 63.50 | 3.125 | 79.38 | 1.13 | 28.58 | 10.4 | 295 |
| CJ | 2.500 | 63.50 | 3.625 | 92.08 | 1.13 | 28.58 | 12.7 | 361 |
| CC | 2.500 | 63.50 | 4.125 | 104.78 | 1.13 | 28.58 | 15.0 | 425 |
| CD | 2.500 | 63.50 | 4.625 | 117.48 | 1.13 | 28.58 | 17.2 | 488 |
| CE | 2.500 | 63.50 | 5.125 | 130.18 | 1.13 | 28.58 | 19.3 | 547 |
| CF | 2.500 | 63.50 | 5.625 | 142.88 | 1.13 | 28.58 | 21.4 | 607 |
| DB | 3.000 | 76.20 | 3.125 | 79.38 | 1.25 | 31.75 | 16.7 | 473 |
| DJ | 3.000 | 76.20 | 3.625 | 92.08 | 1.25 | 31.75 | 20.0 | 567 |
| DC | 3.000 | 76.20 | 4.125 | 104.78 | 1.25 | 31.75 | 22.2 | 629 |
| DD | 3.000 | 76.20 | 4.625 | 117.48 | 1.25 | 31.75 | 25.5 | 723 |
| DE | 3.000 | 76.20 | 5.125 | 130.18 | 1.25 | 31.75 | 30.0 | 850 |
| DF | 3.000 | 76.20 | 5.625 | 142.88 | 1.25 | 31.75 | 31.9 | 904 |
| DP | 3.000 | 76.20 | 5.875 | 149.23 | 1.25 | 31.75 | 32.8 | 931 |
| DN | 3.000 | 76.20 | 7.625 | 193.68 | 1.25 | 31.75 | 39.5 | 1119 |
| DG | 3.000 | 76.20 | 8.625 | 219.08 | 1.25 | 31.75 | 43.3 | 1227 |
| FC | 3.500 | 88.90 | 4.125 | 104.78 | 1.25 | 31.75 | 30.0 | 850 |
| FD | 3.500 | 88.90 | 4.625 | 117.48 | 1.25 | 31.75 | 34.4 | 976 |
| FE | 3.500 | 88.90 | 5.125 | 130.18 | 1.25 | 31.75 | 40.5 | 1148 |
| FF | 3.500 | 88.90 | 5.625 | 142.88 | 1.25 | 31.75 | 43.1 | 1221 |
| FP | 3.500 | 88.90 | 5.875 | 149.23 | 1.25 | 31.75 | 44.3 | 1257 |
| FN | 3.500 | 88.90 | 7.625 | 193.68 | 1.25 | 31.75 | 53.3 | 1512 |
| FG | 3.500 | 88.90 | 8.625 | 219.08 | 1.25 | 31.75 | 58.5 | 1658 |

Type DCMC 85 °C High Capacitance, Screw Terminal, Aluminum

Highest Capacitance Screw Terminal Type Ratings

| Cap. (µF) | Catalog Part Number | ESR Max. @ 25 °C 120 Hz (mΩ) | Ripple Max. @ 85°C 120 Hz (A) | Nominal Size D x L (inches) |
|------------------------------|---------------------|------------------------------|-------------------------------|-----------------------------|
| 6.3 Vdc (8 Vdc Surge) | | | | |
| 28000 | DCMC283U6R3AK2B | 46.9 | 4.1 | 1 3/8 x 1 5/8 |
| 57000 | DCMC573U6R3AA2B | 26.5 | 6.1 | 1 3/8 x 2 1/8 |
| 68000 | DCMC683U6R3AH2B | 18.8 | 7.8 | 1 3/8 x 2 5/8 |
| 91000 | DCMC913U6R3AB2B | 14.7 | 9.4 | 1 3/8 x 3 1/8 |
| 100000 | DCMC104U6R3EA2B | 18.8 | 8.8 | 1 3/4 x 2 1/8 |
| 110000 | DCMC114U6R3AJ2B | 12.8 | 11.2 | 1 3/8 x 3 5/8 |
| 120000 | DCMC124U6R3EH2B | 14.3 | 11.0 | 1 3/4 x 2 5/8 |
| 130000 | DCMC134U6R3AC2B | 11.0 | 13.0 | 1 3/8 x 4 1/8 |
| 130000 | DCMC134U6R3BA2B | 14.2 | 11.9 | 2 x 2 1/8 |
| 150000 | DCMC154U6R3BH2B | 9.9 | 11.6 | 2 x 2 5/8 |
| 160000 | DCMC164U6R3AD2B | 9.8 | 12.5 | 1 3/8 x 4 5/8 |
| 160000 | DCMC164U6R3EB2B | 11.0 | 12.6 | 1 3/4 x 3 1/8 |
| 180000 | DCMC184U6R3AE2B | 8.9 | 14.7 | 1 3/8 x 5 1/8 |
| 200000 | DCMC204U6R3AF2B | 8.3 | 16.0 | 1 3/8 x 5 5/8 |
| 200000 | DCMC204U6R3EJ2B | 9.1 | 15.9 | 1 3/4 x 3 5/8 |
| 210000 | DCMC214U6R3BB2B | 7.8 | 17.8 | 2 x 3 1/8 |
| 240000 | DCMC244U6R3EC2B | 7.9 | 18.3 | 1 3/4 x 4 1/8 |
| 260000 | DCMC264U6R3BJ2B | 6.5 | 15.6 | 2 x 3 5/8 |
| 260000 | DCMC264U6R3CH2B | 6.9 | 16.2 | 2 1/2 x 2 5/8 |
| 280000 | DCMC284U6R3ED2B | 7.0 | 17.1 | 1 3/4 x 4 5/8 |
| 310000 | DCMC314U6R3BC2B | 5.6 | 20.2 | 2 x 4 1/8 |
| 320000 | DCMC324U6R3EE2B | 6.4 | 19.7 | 1 3/4 x 5 1/8 |
| 350000 | DCMC354U6R3CB2B | 5.3 | 22.6 | 2 1/2 x 3 1/8 |
| 360000 | DCMC364U6R3EF2B | 6.0 | 22.0 | 1 3/4 x 5 5/8 |
| 370000 | DCMC374U6R3BD2B | 5.0 | 24.9 | 2 x 4 5/8 |
| 420000 | DCMC424U6R3BE2B | 4.5 | 23.0 | 2 x 5 1/8 |
| 440000 | DCMC444U6R3CJ2B | 4.3 | 25.0 | 2 1/2 x 3 5/8 |
| 470000 | DCMC474U6R3BF2B | 4.2 | 26.7 | 2 x 5 5/8 |
| 520000 | DCMC524U6R3DB2B | 4.1 | 28.3 | 3 x 3 1/8 |
| 530000 | DCMC534U6R3CC2D | 3.8 | 30.4 | 2 1/2 x 4 1/8 |
| 610000 | DCMC614U6R3CD2D | 3.4 | 33.4 | 2 1/2 x 4 5/8 |
| 650000 | DCMC654U6R3DJ2D | 3.3 | 34.6 | 3 x 3 5/8 |
| 700000 | DCMC704U6R3CE2D | 3.1 | 33.3 | 2 1/2 x 5 1/8 |
| 780000 | DCMC784U6R3DC2D | 2.9 | 35.7 | 3 x 4 1/8 |
| 790000 | DCMC794U6R3CF2D | 2.8 | 37.9 | 2 1/2 x 5 5/8 |
| 910000 | DCMC914U6R3DD2D | 2.6 | 41.0 | 3 x 4 5/8 |
| 1000000 | DCMC105U6R3DE2D | 2.4 | 44.4 | 3 x 5 1/8 |
| 1100000 | DCMC115U6R3DF2D | 2.4 | 45.0 | 3 x 5 5/8 |
| 1100000 | DCMC115U6R3FC2D | 3.0 | 41.4 | 3 1/2 x 4 1/8 |
| 1200000 | DCMC125U6R3DP2D | 2.4 | 51.5 | 3 x 5 7/8 |
| 1200000 | DCMC125U6R3FD2D | 2.6 | 43.2 | 3 1/2 x 4 5/8 |
| 1400000 | DCMC145U6R3FE2D | 2.4 | 47.1 | 3 1/2 x 5 1/8 |
| 1600000 | DCMC165U6R3DN2D | 2.4 | 49.3 | 3 x 7 5/8 |
| 1600000 | DCMC165U6R3FF2D | 2.4 | 47.9 | 3 1/2 x 5 5/8 |
| 1700000 | DCMC175U6R3FP2D | 2.4 | 49.4 | 3 1/2 x 5 7/8 |
| 1900000 | DCMC195U6R3DG2D | 2.4 | 49.9 | 3 x 8 5/8 |
| 2300000 | DCMC235U6R3FN2D | 2.4 | 54.1 | 3 1/2 x 7 5/8 |

| Cap. (µF) | Catalog Part Number | ESR Max. @ 25 °C 120 Hz (mΩ) | Ripple Max. @ 85°C 120 Hz (A) | Nominal Size D x L (inches) |
|------------------------------|---------------------|------------------------------|-------------------------------|-----------------------------|
| 2700000 | DCMC275U6R3FG2D | 2.4 | 56.5 | 3 1/2 x 8 5/8 |
| 10 Vdc (12 Vdc Surge) | | | | |
| 24000 | DCMC243U010AK2B | 46.9 | 4.1 | 1 3/8 x 1 5/8 |
| 44000 | DCMC443U010AA2B | 26.5 | 6.1 | 1 3/8 x 2 1/8 |
| 57000 | DCMC573U010AH2B | 20.1 | 7.5 | 1 3/8 x 2 5/8 |
| 76000 | DCMC763U010AB2B | 15.5 | 9.2 | 1 3/8 x 3 1/8 |
| 79000 | DCMC793U010EA2B | 18.8 | 8.8 | 1 3/4 x 2 1/8 |
| 96000 | DCMC963U010AJ2B | 12.8 | 11.2 | 1 3/8 x 3 5/8 |
| 100000 | DCMC104U010EH2B | 14.3 | 11.0 | 1 3/4 x 2 5/8 |
| 100000 | DCMC104U010BA2B | 17.6 | 10.3 | 2 x 2 1/8 |
| 110000 | DCMC114U010AC2B | 11.0 | 13.5 | 1 3/8 x 4 1/8 |
| 130000 | DCMC134U010AD2B | 9.8 | 11.6 | 1 3/8 x 4 5/8 |
| 140000 | DCMC144U010EB2B | 11.0 | 11.8 | 1 3/4 x 3 1/8 |
| 140000 | DCMC144U010BH2B | 13.4 | 11.4 | 2 x 2 5/8 |
| 150000 | DCMC154U010AE2B | 8.9 | 14.7 | 1 3/8 x 5 1/8 |
| 170000 | DCMC174U010AF2B | 8.3 | 16.0 | 1 3/8 x 5 5/8 |
| 170000 | DCMC174U010EJ2B | 9.1 | 15.9 | 1 3/4 x 3 5/8 |
| 180000 | DCMC184U010BB2B | 10.5 | 15.4 | 2 x 3 1/8 |
| 210000 | DCMC214U010EC2B | 7.9 | 18.3 | 1 3/4 x 4 1/8 |
| 220000 | DCMC224U010BJ2B | 8.7 | 13.5 | 2 x 3 5/8 |
| 220000 | DCMC224U010CH2B | 8.8 | 14.4 | 2 1/2 x 2 5/8 |
| 240000 | DCMC244U010ED2B | 7.0 | 17.1 | 1 3/4 x 4 5/8 |
| 270000 | DCMC274U010BC2B | 7.5 | 17.4 | 2 x 4 1/8 |
| 280000 | DCMC284U010EE2B | 6.4 | 19.7 | 1 3/4 x 5 1/8 |
| 290000 | DCMC294U010CB2B | 6.7 | 20.0 | 2 1/2 x 3 1/8 |
| 310000 | DCMC314U010EF2B | 6.0 | 22.0 | 1 3/4 x 5 5/8 |
| 310000 | DCMC314U010BD2B | 6.7 | 21.5 | 2 x 4 5/8 |
| 350000 | DCMC354U010BE2B | 6.1 | 19.8 | 2 x 5 1/8 |
| 370000 | DCMC374U010CJ2B | 5.5 | 22.1 | 2 1/2 x 3 5/8 |
| 400000 | DCMC404U010BF2B | 5.7 | 22.9 | 2 x 5 5/8 |
| 430000 | DCMC434U010DB2B | 4.1 | 28.3 | 3 x 3 1/8 |
| 440000 | DCMC444U010CC2B | 4.8 | 26.9 | 2 1/2 x 4 1/8 |
| 510000 | DCMC514U010CD2B | 4.3 | 29.5 | 2 1/2 x 4 5/8 |
| 540000 | DCMC544U010DJ2D | 3.3 | 34.6 | 3 x 3 5/8 |
| 590000 | DCMC594U010CE2B | 3.9 | 29.5 | 2 1/2 x 5 1/8 |
| 640000 | DCMC644U010DC2D | 2.9 | 35.7 | 3 x 4 1/8 |
| 660000 | DCMC664U010CF2D | 3.6 | 33.5 | 2 1/2 x 5 5/8 |
| 750000 | DCMC754U010DD2D | 2.6 | 41.0 | 3 x 4 5/8 |
| 860000 | DCMC864U010DE2D | 2.4 | 44.4 | 3 x 5 1/8 |
| 900000 | DCMC904U010FC2D | 2.9 | 41.6 | 3 1/2 x 4 1/8 |
| 940000 | DCMC944U010DF2D | 2.3 | 47.1 | 3 x 5 5/8 |
| 1000000 | DCMC105U010DP2D | 2.3 | 52.8 | 3 x 5 7/8 |
| 1000000 | DCMC105U010FD2D | 2.8 | 42.0 | 3 1/2 x 4 5/8 |
| 1200000 | DCMC125U010FE2D | 2.5 | 46.3 | 3 1/2 x 5 1/8 |
| 1300000 | DCMC135U010FF2D | 2.2 | 50.3 | 3 1/2 x 5 5/8 |
| 1400000 | DCMC145U010DN2D | 2.1 | 52.7 | 3 x 7 5/8 |
| 1400000 | DCMC145U010FP2D | 2.1 | 52.7 | 3 1/2 x 5 7/8 |
| 1600000 | DCMC165U010DG2D | 2.1 | 54.2 | 3 x 8 5/8 |

Type DCMC 85 °C High Capacitance, Screw Terminal, Aluminum

Highest Capacitance Screw Terminal Type

| Cap. (μ F) | Catalog Part Number | ESR Max. @ 25 °C 120 Hz (m Ω) | Ripple Max. @ 85°C 120 Hz (A) | Nominal Size D x L (inches) |
|------------------------------|------------------------|--|--|--------------------------------------|
| 1900000 | DCMC195U010FN2D | 1.8 | 64.3 | 3 1/2 x 7 5/8 |
| 2200000 | DCMC225U010FG2D | 1.5 | 70.6 | 3 1/2 x 8 5/8 |
| 16 Vdc (20 Vdc Surge) | | | | |
| 21000 | DCMC213U016AK2B | 46.9 | 4.1 | 1 3/8 x 1 5/8 |
| 35000 | DCMC353U016AA2B | 26.5 | 6.1 | 1 3/8 x 2 1/8 |
| 49000 | DCMC493U016AH2B | 20.1 | 7.5 | 1 3/8 x 2 5/8 |
| 57000 | DCMC573U016EA2B | 18.8 | 8.3 | 1 3/4 x 2 1/8 |
| 62000 | DCMC623U016AB2B | 15.5 | 9.7 | 1 3/8 x 3 1/8 |
| 73000 | DCMC733U016BA2B | 17.6 | 9.5 | 2 x 2 1/8 |
| 76000 | DCMC763U016AJ2B | 12.8 | 11.7 | 1 3/8 x 3 5/8 |
| 77000 | DCMC773U016EH2B | 15.3 | 11.1 | 1 3/4 x 2 5/8 |
| 90000 | DCMC903U016AC2B | 11.0 | 13.5 | 1 3/8 x 4 1/8 |
| 99000 | DCMC993U016AD2B | 9.8 | 11.6 | 1 3/8 x 4 5/8 |
| 100000 | DCMC104U016EB2B | 12.5 | 11.1 | 1 3/4 x 3 1/8 |
| 110000 | DCMC114U016AE2B | 8.9 | 14.0 | 1 3/8 x 5 1/8 |
| 110000 | DCMC114U016BH2B | 13.4 | 12.0 | 2 x 2 5/8 |
| 130000 | DCMC134U016AF2B | 8.3 | 16.0 | 1 3/8 x 5 5/8 |
| 130000 | DCMC134U016EJ2B | 10.9 | 14.6 | 1 3/4 x 3 5/8 |
| 130000 | DCMC134U016BB2B | 10.5 | 15.4 | 2 x 3 1/8 |
| 150000 | DCMC154U016EC2B | 9.7 | 16.5 | 1 3/4 x 4 1/8 |
| 160000 | DCMC164U016BJ2B | 8.7 | 13.5 | 2 x 3 5/8 |
| 160000 | DCMC164U016CH2B | 8.8 | 14.4 | 2 1/2 x 2 5/8 |
| 180000 | DCMC184U016ED2B | 8.8 | 15.3 | 1 3/4 x 4 5/8 |
| 200000 | DCMC204U016BC2B | 7.5 | 17.4 | 2 x 4 1/8 |
| 210000 | DCMC214U016EE2B | 8.2 | 17.5 | 1 3/4 x 5 1/8 |
| 220000 | DCMC224U016CB2B | 6.7 | 20.0 | 2 1/2 x 3 1/8 |
| 230000 | DCMC234U016EF2B | 7.8 | 19.3 | 1 3/4 x 5 5/8 |
| 230000 | DCMC234U016BD2B | 6.7 | 21.5 | 2 x 4 5/8 |
| 260000 | DCMC264U016BE2B | 6.1 | 19.8 | 2 x 5 1/8 |
| 270000 | DCMC274U016CJ2B | 5.5 | 22.1 | 2 1/2 x 3 5/8 |
| 290000 | DCMC294U016BF2B | 5.7 | 22.9 | 2 x 5 5/8 |
| 320000 | DCMC324U016CC2B | 5.0 | 25.6 | 2 1/2 x 4 1/8 |
| 320000 | DCMC324U016DB2B | 4.2 | 28.9 | 3 x 3 1/8 |
| 380000 | DCMC384U016CD2B | 4.6 | 28.5 | 2 1/2 x 4 5/8 |
| 400000 | DCMC404U016DJ2D | 3.6 | 33.3 | 3 x 3 5/8 |
| 430000 | DCMC434U016CE2B | 4.4 | 27.9 | 2 1/2 x 5 1/8 |
| 480000 | DCMC484U016DC2D | 3.3 | 33.8 | 3 x 4 1/8 |
| 490000 | DCMC494U016CF2D | 4.2 | 31.2 | 2 1/2 x 5 5/8 |
| 560000 | DCMC564U016DD2D | 3.1 | 37.5 | 3 x 4 5/8 |
| 650000 | DCMC654U016DE2D | 2.8 | 40.5 | 3 x 5 1/8 |
| 700000 | DCMC704U016FC2D | 2.9 | 41.6 | 3 1/2 x 4 1/8 |
| 710000 | DCMC714U016DF2D | 2.8 | 42.8 | 3 x 5 5/8 |
| 750000 | DCMC754U016DP2D | 2.8 | 48.3 | 3 x 5 7/8 |
| 810000 | DCMC814U016FD2D | 2.8 | 42.1 | 3 1/2 x 4 5/8 |
| 930000 | DCMC934U016FE2D | 2.5 | 46.2 | 3 1/2 x 5 1/8 |
| 1000000 | DCMC105U016FF2D | 2.4 | 48.3 | 3 1/2 x 5 5/8 |
| 1000000 | DCMC105U016DN2D | 2.6 | 47.5 | 3 x 7 5/8 |
| 1500000 | DCMC155U016FN2D | 2.3 | 55.4 | 3 1/2 x 7 5/8 |

| Cap. (μ F) | Catalog Part Number | ESR Max. @ 25 °C 120 Hz (m Ω) | Ripple Max. @ 85°C 120 Hz (A) | Nominal Size D x L (inches) |
|------------------------------|------------------------|--|--|--------------------------------------|
| 1700000 | DCMC175U016FG2D | 2.3 | 58.2 | 3 1/2 x 8 5/8 |
| 25 Vdc (30 Vdc Surge) | | | | |
| 12000 | DCMC123U025AK2B | 37.1 | 4.7 | 1 3/8 x 1 5/8 |
| 20000 | DCMC203U025AA2B | 23.6 | 6.5 | 1 3/8 x 2 1/8 |
| 24000 | DCMC243U025AH2B | 20.1 | 7.5 | 1 3/8 x 2 5/8 |
| 33000 | DCMC333U025AB2B | 19.3 | 8.2 | 1 3/8 x 3 1/8 |
| 36000 | DCMC363U025EA2B | 21.8 | 8.2 | 1 3/4 x 2 1/8 |
| 42000 | DCMC423U025AJ2B | 19.4 | 9.1 | 1 3/8 x 3 5/8 |
| 43000 | DCMC433U025EH2B | 19.4 | 9.5 | 1 3/4 x 2 5/8 |
| 47000 | DCMC473U025BA2B | 21.8 | 9.3 | 2 x 2 1/8 |
| 52000 | DCMC523U025AC2B | 17.6 | 10.7 | 1 3/8 x 4 1/8 |
| 59000 | DCMC593U025BH2B | 16.5 | 9.0 | 2 x 2 5/8 |
| 60000 | DCMC603U025EB2B | 15.2 | 10.1 | 1 3/4 x 3 1/8 |
| 61000 | DCMC613U025AD2B | 16.4 | 10.3 | 1 3/8 x 4 5/8 |
| 71000 | DCMC713U025AE2B | 15.2 | 11.3 | 1 3/8 x 5 1/8 |
| 76000 | DCMC763U025BB2B | 12.2 | 13.2 | 2 x 3 1/8 |
| 77000 | DCMC773U025EJ2B | 12.8 | 13.4 | 1 3/4 x 3 5/8 |
| 80000 | DCMC803U025AF2B | 14.0 | 13.3 | 1 3/8 x 5 5/8 |
| 90000 | DCMC903U025CH2B | 9.5 | 16.7 | 2 1/2 x 2 5/8 |
| 94000 | DCMC943U025EC2B | 11.2 | 11.8 | 1 3/4 x 4 1/8 |
| 98000 | DCMC983U025BJ2B | 9.8 | 13.6 | 2 x 3 5/8 |
| 110000 | DCMC114U025ED2B | 10.2 | 14.2 | 1 3/4 x 4 5/8 |
| 120000 | DCMC124U025BC2B | 8.3 | 16.6 | 2 x 4 1/8 |
| 130000 | DCMC134U025EE2B | 9.6 | 16.1 | 1 3/4 x 5 1/8 |
| 130000 | DCMC134U025CB2B | 7.6 | 18.9 | 2 1/2 x 3 1/8 |
| 140000 | DCMC144U025BD2B | 7.3 | 19.9 | 2 x 4 5/8 |
| 150000 | DCMC154U025EF2B | 9.1 | 18.4 | 1 3/4 x 5 5/8 |
| 160000 | DCMC164U025BE2B | 6.6 | 19.1 | 2 x 5 1/8 |
| 160000 | DCMC164U025CJ2B | 6.4 | 20.5 | 2 1/2 x 3 5/8 |
| 190000 | DCMC194U025BF2B | 6.1 | 22.2 | 2 x 5 5/8 |
| 190000 | DCMC194U025DB2B | 5.0 | 25.5 | 3 x 3 1/8 |
| 200000 | DCMC204U025CC2B | 5.8 | 24.6 | 2 1/2 x 4 1/8 |
| 230000 | DCMC234U025CD2B | 5.2 | 26.8 | 2 1/2 x 4 5/8 |
| 240000 | DCMC244U025DJ2D | 4.3 | 30.5 | 3 x 3 5/8 |
| 270000 | DCMC274U025CE2B | 5.0 | 26.0 | 2 1/2 x 5 1/8 |
| 300000 | DCMC304U025DC2D | 3.9 | 31.0 | 3 x 4 1/8 |
| 310000 | DCMC314U025CF2B | 4.6 | 29.8 | 2 1/2 x 5 5/8 |
| 350000 | DCMC354U025DD2D | 3.5 | 35.1 | 3 x 4 5/8 |
| 400000 | DCMC404U025DE2D | 3.3 | 37.5 | 3 x 5 1/8 |
| 430000 | DCMC434U025FC2D | 3.8 | 36.0 | 3 1/2 x 4 1/8 |
| 460000 | DCMC464U025DF2D | 3.2 | 39.9 | 3 x 5 5/8 |
| 490000 | DCMC494U025DP2D | 3.1 | 46.0 | 3 x 5 7/8 |
| 500000 | DCMC504U025FD2D | 3.5 | 37.6 | 3 1/2 x 4 5/8 |
| 580000 | DCMC584U025FE2D | 3.2 | 40.3 | 3 1/2 x 5 1/8 |
| 660000 | DCMC664U025FF2D | 3.1 | 42.8 | 3 1/2 x 5 5/8 |
| 670000 | DCMC674U025DN2D | 3.1 | 44.0 | 3 x 7 5/8 |
| 700000 | DCMC704U025FP2D | 2.9 | 44.9 | 3 1/2 x 5 7/8 |
| 780000 | DCMC784U025DG2D | 3.0 | 44.9 | 3 x 8 5/8 |

Type DCMC 85 °C High Capacitance, Screw Terminal, Aluminum

Highest Capacitance Screw Terminal Type

| Cap. (µF) | Catalog Part Number | ESR Max. @ 25 °C 120 Hz (mΩ) | Ripple Max. @ 85°C 120 Hz (A) | Nominal Size D x L (inches) |
|------------------------------|---------------------|------------------------------|-------------------------------|-----------------------------|
| 950000 | DCMC954U025FN2D | 3.0 | 48.7 | 3 1/2 x 7 5/8 |
| 1100000 | DCMC115U025FG2D | 2.9 | 51.1 | 3 1/2 x 8 5/8 |
| 35 Vdc (40 Vdc Surge) | | | | |
| 8200 | DCMC822U035AK2B | 41.7 | 4.4 | 1 3/8 x 1 5/8 |
| 14000 | DCMC143U035AA2B | 26.7 | 6.1 | 1 3/8 x 2 1/8 |
| 16000 | DCMC163U035AH2B | 23.2 | 7.0 | 1 3/8 x 2 5/8 |
| 23000 | DCMC233U035AB2B | 21.9 | 7.7 | 1 3/8 x 3 1/8 |
| 25000 | DCMC253U035EA2B | 22.3 | 8.1 | 1 3/4 x 2 1/8 |
| 30000 | DCMC303U035AJ2B | 21.6 | 8.6 | 1 3/8 x 3 5/8 |
| 30000 | DCMC303U035EH2B | 19.2 | 9.5 | 1 3/4 x 2 5/8 |
| 32000 | DCMC323U035BA2B | 24.5 | 8.8 | 2 x 2 1/8 |
| 36000 | DCMC363U035AC2B | 20.1 | 10.0 | 1 3/8 x 4 1/8 |
| 41000 | DCMC413U035BH2B | 20.1 | 8.1 | 2 x 2 5/8 |
| 42000 | DCMC423U035EB2B | 15.5 | 10.0 | 1 3/4 x 3 1/8 |
| 43000 | DCMC433U035AD2B | 17.8 | 9.9 | 1 3/8 x 4 5/8 |
| 49000 | DCMC493U035AE2B | 15.5 | 11.2 | 1 3/8 x 5 1/8 |
| 53000 | DCMC533U035BB2B | 15.9 | 11.6 | 2 x 3 1/8 |
| 54000 | DCMC543U035EJ2B | 13.2 | 13.2 | 1 3/4 x 3 5/8 |
| 56000 | DCMC563U035AF2B | 14.1 | 13.3 | 1 3/8 x 5 5/8 |
| 63000 | DCMC633U035CH2B | 14.8 | 13.4 | 2 1/2 x 2 5/8 |
| 66000 | DCMC663U035EC2B | 11.8 | 11.5 | 1 3/4 x 4 1/8 |
| 69000 | DCMC693U035BJ2B | 13.2 | 11.7 | 2 x 3 5/8 |
| 78000 | DCMC783U035ED2B | 10.6 | 13.9 | 1 3/4 x 4 5/8 |
| 84000 | DCMC843U035BC2B | 11.6 | 14.0 | 2 x 4 1/8 |
| 88000 | DCMC883U035CB2B | 11.5 | 14.7 | 2 1/2 x 3 1/8 |
| 90000 | DCMC903U035EE2B | 9.8 | 16.6 | 1 3/4 x 5 1/8 |
| 99000 | DCMC993U035BD2B | 10.5 | 16.6 | 2 x 4 5/8 |
| 100000 | DCMC104U035EF2B | 9.4 | 18.1 | 1 3/4 x 5 5/8 |
| 110000 | DCMC114U035BE2B | 9.8 | 15.6 | 2 x 5 1/8 |
| 110000 | DCMC114U035CJ2B | 9.4 | 16.9 | 2 1/2 x 3 5/8 |
| 130000 | DCMC134U035BF2B | 9.4 | 17.9 | 2 x 5 5/8 |
| 130000 | DCMC134U035DB2B | 6.9 | 21.8 | 3 x 3 1/8 |
| 140000 | DCMC144U035CC2B | 8.2 | 20.6 | 2 1/2 x 4 1/8 |
| 160000 | DCMC164U035CD2B | 7.4 | 22.5 | 2 1/2 x 4 5/8 |
| 170000 | DCMC174U035DJ2B | 5.7 | 26.4 | 3 x 3 5/8 |
| 190000 | DCMC194U035CE2B | 6.8 | 22.3 | 2 1/2 x 5 1/8 |
| 210000 | DCMC214U035CF2B | 6.1 | 24.7 | 2 1/2 x 5 5/8 |
| 210000 | DCMC214U035DC2B | 5.2 | 28.0 | 3 x 4 1/8 |
| 240000 | DCMC244U035DD2D | 4.7 | 30.5 | 3 x 4 5/8 |
| 280000 | DCMC284U035DE2D | 4.4 | 32.6 | 3 x 5 1/8 |
| 300000 | DCMC304U035FC2D | 4.9 | 31.7 | 3 1/2 x 4 1/8 |
| 320000 | DCMC324U035DF2D | 4.0 | 35.5 | 3 x 5 5/8 |
| 340000 | DCMC344U035DP2D | 3.9 | 40.9 | 3 x 5 7/8 |
| 350000 | DCMC354U035FD2D | 4.5 | 33.0 | 3 1/2 x 4 5/8 |
| 410000 | DCMC414U035FE2D | 4.0 | 36.2 | 3 1/2 x 5 1/8 |
| 460000 | DCMC464U035FF2D | 3.6 | 39.2 | 3 1/2 x 5 5/8 |
| 470000 | DCMC474U035DN2D | 3.8 | 39.8 | 3 x 7 5/8 |
| 490000 | DCMC494U035FP2D | 3.5 | 41.1 | 3 1/2 x 5 7/8 |

| Cap. (µF) | Catalog Part Number | ESR Max. @ 25 °C 120 Hz (mΩ) | Ripple Max. @ 85°C 120 Hz (A) | Nominal Size D x L (inches) |
|------------------------------|---------------------|------------------------------|-------------------------------|-----------------------------|
| 550000 | DCMC554U035DG2D | 3.6 | 40.9 | 3 x 8 5/8 |
| 680000 | DCMC684U035FN2D | 3.4 | 45.7 | 3 1/2 x 7 5/8 |
| 790000 | DCMC794U035FG2D | 3.3 | 48.4 | 3 1/2 x 8 5/8 |
| 50 Vdc (65 Vdc Surge) | | | | |
| 5900 | DCMC592U050AK2B | 47.9 | 4.1 | 1 3/8 x 1 5/8 |
| 10000 | DCMC103U050AA2B | 30.9 | 5.6 | 1 3/8 x 2 1/8 |
| 12000 | DCMC123U050AH2B | 25.9 | 6.7 | 1 3/8 x 2 5/8 |
| 16000 | DCMC163U050AB2B | 23.6 | 7.4 | 1 3/8 x 3 1/8 |
| 18000 | DCMC183U050EA2B | 22.8 | 8.0 | 1 3/4 x 2 1/8 |
| 21000 | DCMC213U050AJ2B | 19.6 | 9.0 | 1 3/8 x 3 5/8 |
| 21000 | DCMC213U050EH2B | 20.2 | 9.3 | 1 3/4 x 2 5/8 |
| 23000 | DCMC233U050BA2B | 25.3 | 8.6 | 2 x 2 1/8 |
| 26000 | DCMC263U050AC2B | 18.7 | 10.4 | 1 3/8 x 4 1/8 |
| 29000 | DCMC293U050BH2B | 20.8 | 8.0 | 2 x 2 5/8 |
| 30000 | DCMC303U050EB2B | 15.6 | 9.9 | 1 3/4 x 3 1/8 |
| 31000 | DCMC313U050AD2B | 17.9 | 9.9 | 1 3/8 x 4 5/8 |
| 35000 | DCMC353U050AE2B | 15.9 | 11.0 | 1 3/8 x 5 1/8 |
| 38000 | DCMC383U050EJ2B | 13.5 | 12.5 | 1 3/4 x 3 5/8 |
| 38000 | DCMC383U050BB2B | 16.3 | 11.9 | 2 x 3 1/8 |
| 40000 | DCMC403U050AF2B | 14.4 | 13.1 | 1 3/8 x 5 5/8 |
| 45000 | DCMC453U050CH2B | 15.1 | 13.3 | 2 1/2 x 2 5/8 |
| 47000 | DCMC473U050EC2B | 12.0 | 11.4 | 1 3/4 x 4 1/8 |
| 49000 | DCMC493U050BJ2B | 13.6 | 11.6 | 2 x 3 5/8 |
| 56000 | DCMC563U050ED2B | 10.8 | 13.8 | 1 3/4 x 4 5/8 |
| 60000 | DCMC603U050BC2B | 11.9 | 13.8 | 2 x 4 1/8 |
| 63000 | DCMC633U050CB2B | 12.0 | 14.4 | 2 1/2 x 3 1/8 |
| 64000 | DCMC643U050EE2B | 9.8 | 16.6 | 1 3/4 x 5 1/8 |
| 71000 | DCMC713U050BD2B | 10.8 | 16.4 | 2 x 4 5/8 |
| 73000 | DCMC733U050EF2B | 9.5 | 18.0 | 1 3/4 x 5 5/8 |
| 81000 | DCMC813U050CJ2B | 10.3 | 15.2 | 2 1/2 x 3 5/8 |
| 82000 | DCMC823U050BE2B | 10.0 | 16.4 | 2 x 5 1/8 |
| 93000 | DCMC933U050BF2B | 9.5 | 17.7 | 2 x 5 5/8 |
| 94000 | DCMC943U050DB2B | 9.1 | 18.9 | 3 x 3 1/8 |
| 99000 | DCMC993U050CC2B | 8.9 | 19.8 | 2 1/2 x 4 1/8 |
| 120000 | DCMC124U050CD2B | 7.9 | 21.8 | 2 1/2 x 4 5/8 |
| 120000 | DCMC124U050DJ2B | 7.7 | 22.7 | 3 x 3 5/8 |
| 130000 | DCMC134U050CE2B | 7.2 | 21.7 | 2 1/2 x 5 1/8 |
| 150000 | DCMC154U050CF2B | 6.7 | 23.7 | 2 1/2 x 5 5/8 |
| 150000 | DCMC154U050DC2B | 6.9 | 24.2 | 3 x 4 1/8 |
| 170000 | DCMC174U050DD2B | 6.1 | 26.7 | 3 x 4 5/8 |
| 200000 | DCMC204U050DE2B | 5.9 | 28.1 | 3 x 5 1/8 |
| 200000 | DCMC204U050FC2D | 6.4 | 27.9 | 3 1/2 x 4 1/8 |
| 230000 | DCMC234U050DF2D | 5.6 | 30.0 | 3 x 5 5/8 |
| 230000 | DCMC234U050FD2D | 5.7 | 33.8 | 3 1/2 x 4 5/8 |
| 240000 | DCMC244U050DP2D | 5.4 | 30.2 | 3 x 5 7/8 |
| 270000 | DCMC274U050FE2D | 5.4 | 31.3 | 3 1/2 x 5 1/8 |
| 310000 | DCMC314U050FF2D | 5.1 | 33.2 | 3 1/2 x 5 5/8 |
| 320000 | DCMC324U050FP2D | 4.9 | 34.8 | 3 1/2 x 5 7/8 |

Type DCMC 85 °C High Capacitance, Screw Terminal, Aluminum

Highest Capacitance Screw Terminal Type

| Cap. (µF) | Catalog Part Number | ESR Max. @ 25 °C 120 Hz (mΩ) | Ripple Max. @ 85°C 120 Hz (A) | Nominal Size D x L (inches) |
|------------------------------|---------------------|------------------------------|-------------------------------|-----------------------------|
| 350000 | DCMC354U050DN2D | 4.5 | 37.5 | 3 x 7 5/8 |
| 390000 | DCMC394U050DG2D | 4.1 | 38.6 | 3 x 8 5/8 |
| 450000 | DCMC454U050FN2D | 4.2 | 41.3 | 3 1/2 x 7 5/8 |
| 520000 | DCMC524U050FG2D | 3.8 | 44.9 | 3 1/2 x 8 5/8 |
| 63 Vdc (75 Vdc Surge) | | | | |
| 4100 | DCMC412U063AK2B | 60.6 | 3.6 | 1 3/8 x 1 5/8 |
| 7000 | DCMC702U063AA2B | 39.0 | 5.0 | 1 3/8 x 2 1/8 |
| 8300 | DCMC832U063AH2B | 32.7 | 5.9 | 1 3/8 x 2 5/8 |
| 12000 | DCMC123U063AB2B | 28.6 | 6.8 | 1 3/8 x 3 1/8 |
| 13000 | DCMC133U063EA2B | 27.9 | 7.2 | 1 3/4 x 2 1/8 |
| 15000 | DCMC153U063AJ2B | 26.1 | 7.8 | 1 3/8 x 3 5/8 |
| 15000 | DCMC153U063EH2B | 25.6 | 8.2 | 1 3/4 x 2 5/8 |
| 15000 | DCMC153U063BA2B | 28.0 | 8.2 | 2 x 2 1/8 |
| 18000 | DCMC183U063AC2B | 22.0 | 9.6 | 1 3/8 x 4 1/8 |
| 18000 | DCMC183U063BH2B | 22.6 | 7.7 | 2 x 2 5/8 |
| 21000 | DCMC213U063AD2B | 19.3 | 8.9 | 1 3/8 x 4 5/8 |
| 21000 | DCMC213U063EB2B | 19.5 | 9.4 | 1 3/4 x 3 1/8 |
| 25000 | DCMC253U063AE2B | 17.3 | 10.6 | 1 3/8 x 5 1/8 |
| 25000 | DCMC253U063BB2B | 18.1 | 10.8 | 2 x 3 1/8 |
| 27000 | DCMC273U063EJ2B | 16.2 | 11.9 | 1 3/4 x 3 5/8 |
| 28000 | DCMC283U063AF2B | 15.8 | 12.5 | 1 3/8 x 5 5/8 |
| 29000 | DCMC293U063CH2B | 26.8 | 9.9 | 2 1/2 x 2 5/8 |
| 32000 | DCMC323U063BJ2B | 15.1 | 10.2 | 2 x 3 5/8 |
| 33000 | DCMC333U063EC2B | 14.2 | 11.3 | 1 3/4 x 4 1/8 |
| 39000 | DCMC393U063ED2B | 12.8 | 12.7 | 1 3/4 x 4 5/8 |
| 39000 | DCMC393U063BC2B | 13.3 | 13.1 | 2 x 4 1/8 |
| 41000 | DCMC413U063CB2B | 19.3 | 11.4 | 2 1/2 x 3 1/8 |
| 45000 | DCMC453U063EE2B | 11.8 | 15.1 | 1 3/4 x 5 1/8 |
| 46000 | DCMC463U063BD2B | 12.1 | 15.5 | 2 x 4 5/8 |
| 51000 | DCMC513U063EF2B | 11.2 | 16.6 | 1 3/4 x 5 5/8 |
| 52000 | DCMC523U063CJ2B | 17.1 | 11.8 | 2 1/2 x 3 5/8 |
| 53000 | DCMC533U063BE2B | 11.3 | 15.5 | 2 x 5 1/8 |
| 60000 | DCMC603U063BF2B | 10.7 | 16.7 | 2 x 5 5/8 |
| 61000 | DCMC613U063DB2B | 14.9 | 14.8 | 3 x 3 1/8 |
| 64000 | DCMC643U063CC2B | 13.7 | 16.0 | 2 1/2 x 4 1/8 |
| 76000 | DCMC763U063CD2B | 11.8 | 17.8 | 2 1/2 x 4 5/8 |
| 78000 | DCMC783U063DJ2B | 12.1 | 18.1 | 3 x 3 5/8 |
| 87000 | DCMC873U063CE2B | 11.0 | 17.6 | 2 1/2 x 5 1/8 |
| 95000 | DCMC953U063DC2B | 10.8 | 18.6 | 3 x 4 1/8 |
| 99000 | DCMC993U063CF2B | 10.5 | 19.7 | 2 1/2 x 5 5/8 |
| 110000 | DCMC114U063DD2B | 9.9 | 21.0 | 3 x 4 5/8 |
| 130000 | DCMC134U063DE2B | 8.8 | 23.0 | 3 x 5 1/8 |
| 130000 | DCMC134U063FC2D | 9.9 | 22.3 | 3 1/2 x 4 1/8 |
| 150000 | DCMC154U063DF2B | 7.9 | 25.3 | 3 x 5 5/8 |
| 150000 | DCMC154U063FD2D | 9.0 | 26.8 | 3 1/2 x 4 5/8 |
| 160000 | DCMC164U063DP2B | 7.5 | 25.5 | 3 x 5 7/8 |
| 180000 | DCMC184U063FE2D | 7.9 | 25.7 | 3 1/2 x 5 1/8 |
| 200000 | DCMC204U063FF2D | 7.2 | 28.0 | 3 1/2 x 5 5/8 |

| Cap. (µF) | Catalog Part Number | ESR Max. @ 25 °C 120 Hz (mΩ) | Ripple Max. @ 85°C 120 Hz (A) | Nominal Size D x L (inches) |
|------------------------------|---------------------|------------------------------|-------------------------------|-----------------------------|
| 210000 | DCMC214U063FP2D | 6.8 | 29.4 | 3 1/2 x 5 7/8 |
| 230000 | DCMC234U063DN2D | 6.5 | 31.2 | 3 x 7 5/8 |
| 250000 | DCMC254U063DG2D | 5.7 | 32.6 | 3 x 8 5/8 |
| 300000 | DCMC304U063FN2D | 5.8 | 35.3 | 3 1/2 x 7 5/8 |
| 350000 | DCMC354U063FG2D | 5.2 | 38.5 | 3 1/2 x 8 5/8 |
| 75 Vdc (95 Vdc Surge) | | | | |
| 3200 | DCMC322U075AK2B | 76.2 | 3.2 | 1 3/8 x 1 5/8 |
| 5300 | DCMC532U075AA2B | 50.7 | 4.4 | 1 3/8 x 2 1/8 |
| 6400 | DCMC642U075AH2B | 41.7 | 5.2 | 1 3/8 x 2 5/8 |
| 9000 | DCMC902U075AB2B | 38.6 | 5.8 | 1 3/8 x 3 1/8 |
| 9900 | DCMC992U075EA2B | 55.6 | 5.1 | 1 3/4 x 2 1/8 |
| 12000 | DCMC123U075AJ2B | 34.3 | 6.8 | 1 3/8 x 3 5/8 |
| 12000 | DCMC123U075EH2B | 47.3 | 6.1 | 1 3/4 x 2 5/8 |
| 12000 | DCMC123U075BA2B | 34.8 | 7.4 | 2 x 2 1/8 |
| 14000 | DCMC143U075AC2B | 30.5 | 8.1 | 1 3/8 x 4 1/8 |
| 14000 | DCMC143U075BH2B | 27.5 | 6.9 | 2 x 2 5/8 |
| 16000 | DCMC163U075EB2B | 34.1 | 6.7 | 1 3/4 x 3 1/8 |
| 17000 | DCMC173U075AD2B | 26.2 | 8.2 | 1 3/8 x 4 5/8 |
| 19000 | DCMC193U075AE2B | 23.8 | 9.0 | 1 3/8 x 5 1/8 |
| 19000 | DCMC193U075BB2B | 21.4 | 10.0 | 2 x 3 1/8 |
| 21000 | DCMC213U075EJ2B | 26.9 | 9.3 | 1 3/4 x 3 5/8 |
| 22000 | DCMC223U075AF2B | 21.4 | 10.8 | 1 3/8 x 5 5/8 |
| 23000 | DCMC233U075CH2B | 30.0 | 9.4 | 2 1/2 x 2 5/8 |
| 25000 | DCMC253U075BJ2B | 18.0 | 9.3 | 2 x 3 5/8 |
| 26000 | DCMC263U075EC2B | 22.3 | 9.0 | 1 3/4 x 4 1/8 |
| 30000 | DCMC303U075ED2B | 19.2 | 10.4 | 1 3/4 x 4 5/8 |
| 30000 | DCMC303U075BC2B | 15.6 | 12.1 | 2 x 4 1/8 |
| 32000 | DCMC323U075CB2B | 21.6 | 10.7 | 2 1/2 x 3 1/8 |
| 35000 | DCMC353U075EE2B | 16.9 | 12.6 | 1 3/4 x 5 1/8 |
| 35000 | DCMC353U075BD2B | 13.9 | 14.4 | 2 x 4 5/8 |
| 40000 | DCMC403U075EF2B | 15.2 | 14.3 | 1 3/4 x 5 5/8 |
| 41000 | DCMC413U075BE2B | 12.8 | 13.7 | 2 x 5 1/8 |
| 41000 | DCMC413U075CJ2B | 17.8 | 12.3 | 2 1/2 x 3 5/8 |
| 46000 | DCMC463U075BF2B | 12.0 | 15.8 | 2 x 5 5/8 |
| 47000 | DCMC473U075DB2B | 18.0 | 13.4 | 3 x 3 1/8 |
| 50000 | DCMC503U075CC2B | 15.1 | 15.2 | 2 1/2 x 4 1/8 |
| 59000 | DCMC593U075CD2B | 13.5 | 16.7 | 2 1/2 x 4 5/8 |
| 61000 | DCMC613U075DJ2B | 14.4 | 16.6 | 3 x 3 5/8 |
| 68000 | DCMC683U075CE2B | 12.0 | 16.8 | 2 1/2 x 5 1/8 |
| 74000 | DCMC743U075DC2B | 12.9 | 17.0 | 3 x 4 1/8 |
| 77000 | DCMC773U075CF2B | 11.2 | 19.0 | 2 1/2 x 5 5/8 |
| 88000 | DCMC883U075DD2B | 11.8 | 19.2 | 3 x 4 5/8 |
| 100000 | DCMC104U075DE2B | 10.4 | 21.1 | 3 x 5 1/8 |
| 100000 | DCMC104U075FC2D | 11.8 | 20.4 | 3 1/2 x 4 1/8 |
| 110000 | DCMC114U075DF2B | 9.4 | 23.3 | 3 x 5 5/8 |
| 120000 | DCMC124U075DP2B | 8.9 | 26.9 | 3 x 5 7/8 |
| 120000 | DCMC124U075FD2D | 10.7 | 21.4 | 3 1/2 x 4 5/8 |
| 140000 | DCMC144U075FE2D | 9.4 | 23.7 | 3 1/2 x 5 1/8 |

Type DCMC 85 °C High Capacitance, Screw Terminal, Aluminum

Highest Capacitance Screw Terminal Type

| Cap. (µF) | Catalog Part Number | ESR Max. @ 25 °C 120 Hz (mΩ) | Ripple Max. @ 85°C 120 Hz (A) | Nominal Size D x L (inches) |
|--------------------------------|---------------------|------------------------------|-------------------------------|-----------------------------|
| 160000 | DCMC164U075FF2D | 8.4 | 25.7 | 3 1/2 x 5 5/8 |
| 170000 | DCMC174U075DN2D | 7.7 | 28.1 | 3 x 7 5/8 |
| 170000 | DCMC174U075FP2D | 8.1 | 27.1 | 3 1/2 x 5 7/8 |
| 200000 | DCMC204U075DG2B | 6.8 | 29.8 | 3 x 8 5/8 |
| 230000 | DCMC234U075FN2D | 6.9 | 32.3 | 3 1/2 x 7 5/8 |
| 270000 | DCMC274U075FG2D | 6.2 | 35.2 | 3 1/2 x 8 5/8 |
| 100 Vdc (125 Vdc Surge) | | | | |
| 1900 | DCMC192U100AK2B | 98.4 | 2.9 | 1 3/8 x 1 5/8 |
| 3100 | DCMC312U100AA2B | 60.2 | 4.0 | 1 3/8 x 2 1/8 |
| 3900 | DCMC392U100AH2B | 51.0 | 4.7 | 1 3/8 x 2 5/8 |
| 5500 | DCMC552U100AB2B | 43.4 | 5.5 | 1 3/8 x 3 1/8 |
| 6000 | DCMC602U100EA2B | 62.0 | 4.8 | 1 3/4 x 2 1/8 |
| 6300 | DCMC632U100BA2B | 51.8 | 5.6 | 2 x 2 1/8 |
| 7000 | DCMC702U100AJ2B | 36.5 | 6.9 | 1 3/8 x 3 5/8 |
| 7100 | DCMC712U100EH2B | 52.8 | 6.0 | 1 3/4 x 2 5/8 |
| 8600 | DCMC862U100AC2B | 33.3 | 7.8 | 1 3/8 x 4 1/8 |
| 9000 | DCMC902U100BH2B | 37.8 | 5.9 | 2 x 2 5/8 |
| 9900 | DCMC992U100EB2B | 38.0 | 6.4 | 1 3/4 x 3 1/8 |
| 10000 | DCMC103U100AD2B | 31.1 | 7.5 | 1 3/8 x 4 5/8 |
| 12000 | DCMC123U100AE2B | 30.0 | 8.0 | 1 3/8 x 5 1/8 |
| 13000 | DCMC133U100AF2B | 29.0 | 8.6 | 1 3/8 x 5 5/8 |
| 13000 | DCMC133U100EJ2B | 29.9 | 8.8 | 1 3/4 x 3 5/8 |
| 13000 | DCMC133U100BB2B | 30.6 | 9.0 | 2 x 3 1/8 |
| 15000 | DCMC153U100CH2B | 33.7 | 8.9 | 2 1/2 x 2 5/8 |
| 16000 | DCMC163U100EC2B | 24.8 | 8.0 | 1 3/4 x 4 1/8 |
| 16000 | DCMC163U100BJ2B | 22.3 | 9.0 | 2 x 3 5/8 |
| 18000 | DCMC183U100ED2B | 21.2 | 9.8 | 1 3/4 x 4 5/8 |
| 20000 | DCMC203U100BC2B | 19.9 | 10.7 | 2 x 4 1/8 |
| 21000 | DCMC213U100EE2B | 18.7 | 11.5 | 1 3/4 x 5 1/8 |
| 21000 | DCMC213U100CB2B | 23.4 | 10.7 | 2 1/2 x 3 1/8 |
| 23000 | DCMC233U100BD2B | 17.7 | 12.8 | 2 x 4 5/8 |
| 24000 | DCMC243U100EF2B | 16.8 | 13.6 | 1 3/4 x 5 5/8 |
| 27000 | DCMC273U100BE2B | 15.6 | 12.4 | 2 x 5 1/8 |
| 27000 | DCMC273U100CJ2B | 19.1 | 11.9 | 2 1/2 x 3 5/8 |
| 31000 | DCMC313U100BF2B | 14.9 | 14.1 | 2 x 5 5/8 |
| 31000 | DCMC313U100DB2B | 19.9 | 12.8 | 3 x 3 1/8 |
| 33000 | DCMC333U100CC2B | 16.5 | 14.6 | 2 1/2 x 4 1/8 |
| 39000 | DCMC393U100CD2B | 14.7 | 16.0 | 2 1/2 x 4 5/8 |
| 40000 | DCMC403U100DJ2B | 16.4 | 15.6 | 3 x 3 5/8 |
| 45000 | DCMC453U100CE2B | 13.4 | 15.9 | 2 1/2 x 5 1/8 |
| 49000 | DCMC493U100DC2B | 14.4 | 16.1 | 3 x 4 1/8 |
| 51000 | DCMC513U100CF2B | 12.5 | 18.0 | 2 1/2 x 5 5/8 |
| 58000 | DCMC583U100DD2B | 13.0 | 18.3 | 3 x 4 5/8 |
| 67000 | DCMC673U100DE2B | 12.0 | 19.7 | 3 x 5 1/8 |
| 67000 | DCMC673U100FC2D | 13.4 | 19.2 | 3 1/2 x 4 1/8 |
| 76000 | DCMC763U100DF2B | 11.2 | 21.3 | 3 x 5 5/8 |
| 79000 | DCMC793U100FD2D | 12.1 | 23.1 | 3 1/2 x 4 5/8 |
| 80000 | DCMC803U100DP2B | 11.1 | 21.0 | 3 x 5 7/8 |

| Cap. (µF) | Catalog Part Number | ESR Max. @ 25 °C 120 Hz (mΩ) | Ripple Max. @ 85°C 120 Hz (A) | Nominal Size D x L (inches) |
|--------------------------------|---------------------|------------------------------|-------------------------------|-----------------------------|
| 92000 | DCMC923U100FE2D | 10.9 | 22.0 | 3 1/2 x 5 1/8 |
| 100000 | DCMC104U100FF2D | 10.2 | 23.4 | 3 1/2 x 5 5/8 |
| 110000 | DCMC114U100DN2B | 9.2 | 25.8 | 3 x 7 5/8 |
| 110000 | DCMC114U100FP2D | 10.0 | 24.3 | 3 1/2 x 5 7/8 |
| 130000 | DCMC134U100DG2B | 8.2 | 27.3 | 3 x 8 5/8 |
| 150000 | DCMC154U100FN2D | 8.3 | 29.5 | 3 1/2 x 7 5/8 |
| 180000 | DCMC184U100FG2D | 7.3 | 32.3 | 3 1/2 x 8 5/8 |
| 160 Vdc (200 Vdc Surge) | | | | |
| 1100 | DCMC112T160AK2B | 149.6 | 2.3 | 1 3/8 x 1 5/8 |
| 1800 | DCMC182T160AA2B | 93.0 | 3.3 | 1 3/8 x 2 1/8 |
| 2300 | DCMC232T160AH2B | 70.5 | 4.0 | 1 3/8 x 2 5/8 |
| 3200 | DCMC322T160AB2B | 58.5 | 4.7 | 1 3/8 x 3 1/8 |
| 3500 | DCMC352T160EA2B | 62.0 | 4.8 | 1 3/4 x 2 1/8 |
| 3700 | DCMC372T160BA2B | 70.5 | 4.8 | 2 x 2 1/8 |
| 4100 | DCMC412T160AJ2B | 50.2 | 5.9 | 1 3/8 x 3 5/8 |
| 4100 | DCMC412T160EH2B | 52.8 | 6.0 | 1 3/4 x 2 5/8 |
| 5000 | DCMC502T160AC2B | 42.9 | 6.9 | 1 3/8 x 4 1/8 |
| 5300 | DCMC532T160BH2B | 46.5 | 5.3 | 2 x 2 5/8 |
| 5800 | DCMC582T160EB2B | 38.0 | 6.4 | 1 3/4 x 3 1/8 |
| 5900 | DCMC592T160AD2B | 37.7 | 6.8 | 1 3/8 x 4 5/8 |
| 6800 | DCMC682T160AE2B | 34.7 | 7.5 | 1 3/8 x 5 1/8 |
| 7400 | DCMC742T160EJ2B | 29.9 | 8.4 | 1 3/4 x 3 5/8 |
| 7400 | DCMC742T160BB2B | 33.5 | 8.3 | 2 x 3 1/8 |
| 7700 | DCMC772T160AF2B | 32.2 | 8.8 | 1 3/8 x 5 5/8 |
| 8300 | DCMC832T160CH2B | 30.1 | 9.4 | 2 1/2 x 2 5/8 |
| 9100 | DCMC912T160EC2B | 24.8 | 8.0 | 1 3/4 x 4 1/8 |
| 9500 | DCMC952T160BJ2B | 26.4 | 8.3 | 2 x 3 5/8 |
| 11000 | DCMC113T160ED2B | 21.2 | 9.8 | 1 3/4 x 4 5/8 |
| 12000 | DCMC123T160EE2B | 18.7 | 11.0 | 1 3/4 x 5 1/8 |
| 12000 | DCMC123T160BC2B | 21.9 | 10.7 | 2 x 4 1/8 |
| 12000 | DCMC123T160CB2B | 21.3 | 11.2 | 2 1/2 x 3 1/8 |
| 14000 | DCMC143T160EF2B | 16.8 | 13.1 | 1 3/4 x 5 5/8 |
| 14000 | DCMC143T160BD2B | 18.8 | 12.8 | 2 x 4 5/8 |
| 15000 | DCMC153T160CJ2B | 17.0 | 11.9 | 2 1/2 x 3 5/8 |
| 16000 | DCMC163T160BE2B | 16.6 | 12.8 | 2 x 5 1/8 |
| 17000 | DCMC173T160DB2B | 14.7 | 14.3 | 3 x 3 1/8 |
| 18000 | DCMC183T160BF2B | 14.9 | 14.8 | 2 x 5 5/8 |
| 18000 | DCMC183T160CC2B | 14.1 | 15.8 | 2 1/2 x 4 1/8 |
| 22000 | DCMC223T160CD2B | 11.9 | 17.8 | 2 1/2 x 4 5/8 |
| 22000 | DCMC223T160DJ2B | 11.5 | 18.6 | 3 x 3 5/8 |
| 25000 | DCMC253T160CE2B | 10.7 | 17.8 | 2 1/2 x 5 1/8 |
| 27000 | DCMC273T160DC2B | 9.6 | 19.7 | 3 x 4 1/8 |
| 28000 | DCMC283T160CF2B | 9.6 | 20.5 | 2 1/2 x 5 5/8 |
| 32000 | DCMC323T160DD2B | 8.2 | 23.0 | 3 x 4 5/8 |
| 37000 | DCMC373T160DE2B | 7.3 | 25.3 | 3 x 5 1/8 |
| 37000 | DCMC373T160FC2D | 9.2 | 23.2 | 3 1/2 x 4 1/8 |
| 42000 | DCMC423T160DF2B | 6.5 | 27.9 | 3 x 5 5/8 |
| 44000 | DCMC443T160FD2D | 7.9 | 28.6 | 3 1/2 x 4 5/8 |

Type DCMC 85 °C High Capacitance, Screw Terminal, Aluminum

Highest Capacitance Screw Terminal Type

| Cap. (µF) | Catalog Part Number | ESR Max. @ 25 °C 120 Hz (mΩ) | Ripple Max. @ 85°C 120 Hz (A) | Nominal Size D x L (inches) |
|--------------------------------|---------------------|------------------------------|-------------------------------|-----------------------------|
| 45000 | DCMC453T160DP2B | 6.2 | 28.1 | 3 x 5 7/8 |
| 51000 | DCMC513T160FE2D | 6.9 | 27.5 | 3 1/2 x 5 1/8 |
| 58000 | DCMC583T160FF2D | 6.2 | 30.0 | 3 1/2 x 5 5/8 |
| 61000 | DCMC613T160FP2D | 5.9 | 31.6 | 3 1/2 x 5 7/8 |
| 62000 | DCMC623T160DN2D | 5.1 | 34.9 | 3 x 7 5/8 |
| 72000 | DCMC723T160DG2D | 4.3 | 37.5 | 3 x 8 5/8 |
| 85000 | DCMC853T160FN2D | 4.9 | 38.8 | 3 1/2 x 7 5/8 |
| 99000 | DCMC993T160FG2D | 4.2 | 42.8 | 3 1/2 x 8 5/8 |
| 200 Vdc (250 Vdc Surge) | | | | |
| 680 | DCMC681T200AK2B | 205.8 | 2.0 | 1 3/8 x 1 5/8 |
| 1000 | DCMC102T200AA2B | 140.3 | 2.6 | 1 3/8 x 2 1/8 |
| 1500 | DCMC152T200AH2B | 100.5 | 3.4 | 1 3/8 x 2 5/8 |
| 1800 | DCMC182T200AB2B | 78.5 | 4.1 | 1 3/8 x 3 1/8 |
| 1900 | DCMC192T200EA2B | 79.1 | 4.3 | 1 3/4 x 2 1/8 |
| 2200 | DCMC222T200AJ2B | 63.9 | 5.0 | 1 3/8 x 3 5/8 |
| 2400 | DCMC242T200EH2B | 62.5 | 5.3 | 1 3/4 x 2 5/8 |
| 2500 | DCMC252T200BA2B | 82.0 | 4.8 | 2 x 2 1/8 |
| 2700 | DCMC272T200AC2B | 51.7 | 6.2 | 1 3/8 x 4 1/8 |
| 3100 | DCMC312T200EB2B | 48.4 | 5.2 | 1 3/4 x 3 1/8 |
| 3300 | DCMC332T200AD2B | 43.2 | 6.0 | 1 3/8 x 4 5/8 |
| 3300 | DCMC332T200BH2B | 61.0 | 5.3 | 2 x 2 5/8 |
| 3800 | DCMC382T200EJ2B | 37.9 | 7.2 | 1 3/4 x 3 5/8 |
| 3900 | DCMC392T200AE2B | 37.8 | 7.5 | 1 3/8 x 5 1/8 |
| 4300 | DCMC432T200BB2B | 46.1 | 7.1 | 2 x 3 1/8 |
| 4500 | DCMC452T200AF2B | 33.4 | 8.6 | 1 3/8 x 5 5/8 |
| 4600 | DCMC462T200EC2B | 31.3 | 9.2 | 1 3/4 x 4 1/8 |
| 5400 | DCMC542T200ED2B | 26.8 | 7.7 | 1 3/4 x 4 5/8 |
| 5500 | DCMC552T200CH2B | 42.2 | 6.6 | 2 1/2 x 2 5/8 |
| 5600 | DCMC562T200BJ2B | 36.2 | 7.5 | 2 x 3 5/8 |
| 6100 | DCMC612T200EE2B | 23.5 | 9.9 | 1 3/4 x 5 1/8 |
| 6900 | DCMC692T200EF2B | 21.0 | 10.9 | 1 3/4 x 5 5/8 |
| 6900 | DCMC692T200BC2B | 28.5 | 9.7 | 2 x 4 1/8 |
| 7100 | DCMC712T200CB2B | 31.2 | 9.6 | 2 1/2 x 3 1/8 |
| 8200 | DCMC822T200BD2B | 24.4 | 11.2 | 2 x 4 5/8 |
| 9100 | DCMC912T200BE2B | 21.7 | 10.5 | 2 x 5 1/8 |
| 10000 | DCMC103T200BF2B | 19.6 | 11.7 | 2 x 5 5/8 |
| 10000 | DCMC103T200CJ2B | 22.3 | 11.6 | 2 1/2 x 3 5/8 |
| 11000 | DCMC113T200CC2B | 20.3 | 12.7 | 2 1/2 x 4 1/8 |
| 11000 | DCMC113T200DB2B | 30.3 | 10.8 | 3 x 3 1/8 |
| 12000 | DCMC123T200CD2B | 17.3 | 14.7 | 2 1/2 x 4 5/8 |
| 13000 | DCMC133T200CE2B | 15.8 | 15.9 | 2 1/2 x 5 1/8 |
| 13000 | DCMC133T200DJ2B | 23.7 | 12.0 | 3 x 3 5/8 |
| 15000 | DCMC153T200CF2B | 13.7 | 16.5 | 2 1/2 x 5 5/8 |
| 15000 | DCMC153T200DC2B | 19.7 | 14.3 | 3 x 4 1/8 |
| 18000 | DCMC183T200DD2B | 16.9 | 16.1 | 3 x 4 5/8 |
| 21000 | DCMC213T200FC2B | 17.1 | 16.5 | 3 1/2 x 4 1/8 |
| 22000 | DCMC223T200DE2B | 14.8 | 18.2 | 3 x 5 1/8 |
| 24000 | DCMC243T200DF2B | 13.3 | 19.5 | 3 x 5 5/8 |

| Cap. (µF) | Catalog Part Number | ESR Max. @ 25 °C 120 Hz (mΩ) | Ripple Max. @ 85°C 120 Hz (A) | Nominal Size D x L (inches) |
|--------------------------------|---------------------|------------------------------|-------------------------------|-----------------------------|
| 25000 | DCMC253T200FD2B | 15.3 | 20.5 | 3 1/2 x 4 5/8 |
| 26000 | DCMC263T200DP2B | 12.7 | 19.7 | 3 x 5 7/8 |
| 28000 | DCMC283T200FE2B | 13.4 | 19.8 | 3 1/2 x 5 1/8 |
| 31000 | DCMC313T200FF2B | 12.0 | 21.6 | 3 1/2 x 5 5/8 |
| 33000 | DCMC333T200DN2B | 10.8 | 23.7 | 3 x 7 5/8 |
| 33000 | DCMC333T200FP2D | 11.5 | 22.7 | 3 1/2 x 5 7/8 |
| 37000 | DCMC373T200DG2B | 9.6 | 25.2 | 3 x 8 5/8 |
| 44000 | DCMC443T200FN2D | 9.3 | 28.2 | 3 1/2 x 7 5/8 |
| 51000 | DCMC513T200FG2D | 7.9 | 31.1 | 3 1/2 x 8 5/8 |
| 250 Vdc (300 Vdc Surge) | | | | |
| 470 | DCMC471T250AK2B | 259.7 | 1.8 | 1 3/8 x 1 5/8 |
| 820 | DCMC821T250AA2B | 156.4 | 2.5 | 1 3/8 x 2 1/8 |
| 1200 | DCMC122T250AH2B | 118.7 | 3.1 | 1 3/8 x 2 5/8 |
| 1400 | DCMC142T250EA2B | 99.0 | 3.6 | 1 3/4 x 2 1/8 |
| 1500 | DCMC152T250AB2B | 88.0 | 4.1 | 1 3/8 x 3 1/8 |
| 1800 | DCMC182T250EH2B | 83.3 | 4.4 | 1 3/4 x 2 5/8 |
| 1800 | DCMC182T250BA2B | 94.7 | 4.3 | 2 x 2 1/8 |
| 1900 | DCMC192T250AJ2B | 69.5 | 5.2 | 1 3/8 x 3 5/8 |
| 2300 | DCMC232T250AC2B | 57.9 | 5.9 | 1 3/8 x 4 1/8 |
| 2300 | DCMC232T250EB2B | 61.3 | 4.6 | 1 3/4 x 3 1/8 |
| 2400 | DCMC242T250AD2B | 51.4 | 5.5 | 1 3/8 x 4 5/8 |
| 2500 | DCMC252T250BH2B | 65.7 | 5.2 | 2 x 2 5/8 |
| 2700 | DCMC272T250AE2B | 44.0 | 6.6 | 1 3/8 x 5 1/8 |
| 3000 | DCMC302T250EJ2B | 48.7 | 6.6 | 1 3/4 x 3 5/8 |
| 3300 | DCMC332T250BB2B | 46.2 | 7.1 | 2 x 3 1/8 |
| 3400 | DCMC342T250AF2B | 38.3 | 8.0 | 1 3/8 x 5 5/8 |
| 3700 | DCMC372T250EC2B | 40.5 | 8.1 | 1 3/4 x 4 1/8 |
| 3900 | DCMC392T250ED2B | 34.8 | 6.7 | 1 3/4 x 4 5/8 |
| 3900 | DCMC392T250BJ2B | 38.2 | 6.9 | 2 x 3 5/8 |
| 4100 | DCMC412T250CH2B | 51.8 | 6.3 | 2 1/2 x 2 5/8 |
| 4500 | DCMC452T250EE2B | 30.6 | 8.6 | 1 3/4 x 5 1/8 |
| 4700 | DCMC472T250BC2B | 31.5 | 8.9 | 2 x 4 1/8 |
| 5000 | DCMC502T250EF2B | 27.3 | 9.9 | 1 3/4 x 5 5/8 |
| 5200 | DCMC522T250CB2B | 32.1 | 9.5 | 2 1/2 x 3 1/8 |
| 5600 | DCMC562T250BD2B | 26.9 | 10.7 | 2 x 4 5/8 |
| 6200 | DCMC622T250BE2B | 23.6 | 10.1 | 2 x 5 1/8 |
| 6400 | DCMC642T250CJ2B | 25.1 | 10.4 | 2 1/2 x 3 5/8 |
| 6800 | DCMC682T250BF2B | 21.2 | 11.9 | 2 x 5 5/8 |
| 7800 | DCMC782T250DB2B | 27.6 | 10.9 | 3 x 3 1/8 |
| 8200 | DCMC822T250CC2B | 20.8 | 13.0 | 2 1/2 x 4 1/8 |
| 10000 | DCMC103T250CD2B | 17.8 | 14.5 | 2 1/2 x 4 5/8 |
| 10000 | DCMC103T250DJ2B | 21.6 | 13.6 | 3 x 3 5/8 |
| 11000 | DCMC113T250CE2B | 15.5 | 14.8 | 2 1/2 x 5 1/8 |
| 12000 | DCMC123T250CF2B | 13.8 | 16.5 | 2 1/2 x 5 5/8 |
| 12000 | DCMC123T250DC2B | 17.6 | 15.2 | 3 x 4 1/8 |
| 13000 | DCMC133T250DD2B | 16.3 | 16.4 | 3 x 4 5/8 |
| 15000 | DCMC153T250DE2B | 14.3 | 18.0 | 3 x 5 1/8 |
| 16000 | DCMC163T250FC2D | 19.5 | 15.9 | 3 1/2 x 4 1/8 |

Type DCMC 85 °C High Capacitance, Screw Terminal, Aluminum

Highest Capacitance Screw Terminal Type

| Cap. (µF) | Catalog Part Number | ESR Max. @ 25 °C 120 Hz (mΩ) | Ripple Max. @ 85°C 120 Hz (A) | Nominal Size D x L (inches) |
|--------------------------------|---------------------|------------------------------|-------------------------------|-----------------------------|
| 18000 | DCMC183T250DF2B | 12.0 | 20.6 | 3 x 5 5/8 |
| 18000 | DCMC183T250FD2D | 17.1 | 19.4 | 3 1/2 x 4 5/8 |
| 19000 | DCMC193T250DP2B | 11.5 | 20.6 | 3 x 5 7/8 |
| 21000 | DCMC213T250FE2D | 15.1 | 18.7 | 3 1/2 x 5 1/8 |
| 23000 | DCMC233T250FF2D | 13.4 | 20.4 | 3 1/2 x 5 5/8 |
| 24000 | DCMC243T250FP2D | 12.9 | 21.4 | 3 1/2 x 5 7/8 |
| 27000 | DCMC273T250DN2D | 9.5 | 27.2 | 3 x 7 5/8 |
| 30000 | DCMC303T250DG2B | 7.0 | 29.6 | 3 x 8 5/8 |
| 33000 | DCMC333T250FN2D | 10.6 | 26.2 | 3 1/2 x 7 5/8 |
| 38000 | DCMC383T250FG2D | 9.2 | 28.8 | 3 1/2 x 8 5/8 |
| 300 Vdc (350 Vdc Surge) | | | | |
| 330 | DCMC331T300AK2B | 418.1 | 1.4 | 1 3/8 x 1 5/8 |
| 600 | DCMC601T300AA2B | 231.4 | 2.1 | 1 3/8 x 2 1/8 |
| 730 | DCMC731T300AH2B | 188.8 | 2.5 | 1 3/8 x 2 5/8 |
| 1000 | DCMC102T300AB2B | 137.5 | 3.1 | 1 3/8 x 3 1/8 |
| 1000 | DCMC102T300EA2B | 139.3 | 3.2 | 1 3/4 x 2 1/8 |
| 1200 | DCMC122T300EH2B | 117.2 | 3.7 | 1 3/4 x 2 5/8 |
| 1200 | DCMC122T300BA2B | 131.1 | 3.6 | 2 x 2 1/8 |
| 1300 | DCMC132T300AJ2B | 106.8 | 4.2 | 1 3/8 x 3 5/8 |
| 1500 | DCMC152T300AC2B | 90.4 | 4.7 | 1 3/8 x 4 1/8 |
| 1500 | DCMC152T300BH2B | 102.6 | 3.6 | 2 x 2 5/8 |
| 1700 | DCMC172T300EB2B | 84.5 | 4.3 | 1 3/4 x 3 1/8 |
| 1800 | DCMC182T300AD2B | 77.4 | 4.7 | 1 3/8 x 4 5/8 |
| 2100 | DCMC212T300AE2B | 65.7 | 5.4 | 1 3/8 x 5 1/8 |
| 2100 | DCMC212T300EJ2B | 68.3 | 5.6 | 1 3/4 x 3 5/8 |
| 2200 | DCMC222T300BB2B | 71.1 | 5.7 | 2 x 3 1/8 |
| 2300 | DCMC232T300AF2B | 60.3 | 6.4 | 1 3/8 x 5 5/8 |
| 2600 | DCMC262T300EC2B | 56.7 | 6.8 | 1 3/4 x 4 1/8 |
| 2600 | DCMC262T300CH2B | 60.5 | 5.1 | 2 1/2 x 2 5/8 |
| 2800 | DCMC282T300BJ2B | 55.5 | 5.7 | 2 x 3 5/8 |
| 3000 | DCMC302T300ED2B | 48.5 | 6.5 | 1 3/4 x 4 5/8 |
| 3300 | DCMC332T300CB2B | 46.5 | 7.0 | 2 1/2 x 3 1/8 |
| 3400 | DCMC342T300BC2B | 45.7 | 7.4 | 2 x 4 1/8 |
| 3500 | DCMC352T300EE2B | 42.5 | 8.0 | 1 3/4 x 5 1/8 |
| 3900 | DCMC392T300EF2B | 37.9 | 8.7 | 1 3/4 x 5 5/8 |
| 4000 | DCMC402T300BD2B | 38.9 | 8.9 | 2 x 4 5/8 |
| 4200 | DCMC422T300CJ2B | 38.1 | 7.9 | 2 1/2 x 3 5/8 |
| 4600 | DCMC462T300BE2B | 34.0 | 8.9 | 2 x 5 1/8 |
| 4800 | DCMC482T300DB2B | 42.8 | 8.4 | 3 x 3 1/8 |
| 5200 | DCMC522T300CC2B | 29.9 | 10.4 | 2 1/2 x 4 1/8 |
| 5300 | DCMC532T300BF2B | 30.2 | 10.8 | 2 x 5 5/8 |
| 6000 | DCMC602T300DJ2B | 34.0 | 10.5 | 3 x 3 5/8 |
| 6100 | DCMC612T300CD2B | 25.5 | 12.5 | 2 1/2 x 4 5/8 |
| 7100 | DCMC712T300CE2B | 22.2 | 12.3 | 2 1/2 x 5 1/8 |
| 7400 | DCMC742T300DC2B | 26.2 | 11.9 | 3 x 4 1/8 |
| 8000 | DCMC802T300CF2B | 19.8 | 14.3 | 2 1/2 x 5 5/8 |
| 8700 | DCMC872T300DD2B | 23.6 | 13.6 | 3 x 4 5/8 |
| 10000 | DCMC103T300DE2B | 20.5 | 15.1 | 3 x 5 1/8 |

| Cap. (µF) | Catalog Part Number | ESR Max. @ 25 °C 120 Hz (mΩ) | Ripple Max. @ 85°C 120 Hz (A) | Nominal Size D x L (inches) |
|--------------------------------|---------------------|------------------------------|-------------------------------|-----------------------------|
| 10000 | DCMC103T300FC2D | 21.0 | 15.3 | 3 1/2 x 4 1/8 |
| 11000 | DCMC113T300DF2B | 18.0 | 16.8 | 3 x 5 5/8 |
| 12000 | DCMC123T300DP2B | 17.0 | 19.5 | 3 x 5 7/8 |
| 12000 | DCMC123T300FD2D | 18.2 | 16.4 | 3 1/2 x 4 5/8 |
| 13000 | DCMC133T300FE2D | 16.0 | 18.1 | 3 1/2 x 5 1/8 |
| 15000 | DCMC153T300FF2D | 14.3 | 19.8 | 3 1/2 x 5 5/8 |
| 16000 | DCMC163T300DN2B | 13.2 | 21.8 | 3 x 7 5/8 |
| 16000 | DCMC163T300FP2D | 13.5 | 20.9 | 3 1/2 x 5 7/8 |
| 19000 | DCMC193T300DG2B | 10.8 | 23.7 | 3 x 8 5/8 |
| 22000 | DCMC223T300FN2D | 11.0 | 25.9 | 3 1/2 x 7 5/8 |
| 26000 | DCMC263T300FG2D | 9.3 | 28.6 | 3 1/2 x 8 5/8 |
| 350 Vdc (400 Vdc Surge) | | | | |
| 220 | DCMC221T350AK2B | 605.4 | 1.2 | 1 3/8 x 1 5/8 |
| 430 | DCMC431T350AA2B | 378.8 | 1.6 | 1 3/8 x 2 1/8 |
| 510 | DCMC511T350AH2B | 253.0 | 2.1 | 1 3/8 x 2 5/8 |
| 680 | DCMC681T350AB2B | 190.2 | 2.6 | 1 3/8 x 3 1/8 |
| 760 | DCMC761T350EA2B | 176.6 | 2.9 | 1 3/4 x 2 1/8 |
| 860 | DCMC861T350AJ2B | 152.5 | 3.2 | 1 3/8 x 3 5/8 |
| 920 | DCMC921T350EH2B | 161.7 | 3.3 | 1 3/4 x 2 5/8 |
| 990 | DCMC991T350BA2B | 167.6 | 3.3 | 2 x 2 1/8 |
| 1000 | DCMC102T350AC2B | 127.5 | 4.0 | 1 3/8 x 4 1/8 |
| 1200 | DCMC122T350AD2B | 109.6 | 3.5 | 1 3/8 x 4 5/8 |
| 1200 | DCMC122T350EB2B | 124.7 | 3.5 | 1 3/4 x 3 1/8 |
| 1200 | DCMC122T350BH2B | 132.2 | 3.6 | 2 x 2 5/8 |
| 1300 | DCMC132T350AE2B | 97.2 | 4.5 | 1 3/8 x 5 1/8 |
| 1500 | DCMC152T350AF2B | 85.9 | 5.0 | 1 3/8 x 5 5/8 |
| 1500 | DCMC152T350EJ2B | 97.3 | 4.9 | 1 3/4 x 3 5/8 |
| 1500 | DCMC152T350BB2B | 101.5 | 4.9 | 2 x 3 1/8 |
| 1800 | DCMC182T350EC2B | 79.9 | 5.8 | 1 3/4 x 4 1/8 |
| 1900 | DCMC192T350BJ2B | 79.2 | 4.4 | 2 x 3 5/8 |
| 2000 | DCMC202T350CH2B | 86.9 | 4.6 | 2 1/2 x 2 5/8 |
| 2100 | DCMC212T350ED2B | 67.8 | 5.5 | 1 3/4 x 4 5/8 |
| 2300 | DCMC232T350BC2B | 65.1 | 5.9 | 2 x 4 1/8 |
| 2400 | DCMC242T350EE2B | 59.1 | 6.5 | 1 3/4 x 5 1/8 |
| 2500 | DCMC252T350CB2B | 61.0 | 6.6 | 2 1/2 x 3 1/8 |
| 2700 | DCMC272T350EF2B | 52.4 | 7.4 | 1 3/4 x 5 5/8 |
| 2700 | DCMC272T350BD2B | 55.4 | 7.5 | 2 x 4 5/8 |
| 3100 | DCMC312T350BE2B | 48.7 | 7.0 | 2 x 5 1/8 |
| 3100 | DCMC312T350CJ2B | 48.5 | 7.5 | 2 1/2 x 3 5/8 |
| 3500 | DCMC352T350BF2B | 42.8 | 8.3 | 2 x 5 5/8 |
| 3700 | DCMC372T350CC2B | 39.9 | 9.0 | 2 1/2 x 4 1/8 |
| 3800 | DCMC382T350DB2B | 54.0 | 8.1 | 3 x 3 1/8 |
| 4200 | DCMC422T350CD2B | 34.0 | 10.5 | 2 1/2 x 4 5/8 |
| 4600 | DCMC462T350DJ2B | 41.7 | 9.8 | 3 x 3 5/8 |
| 4800 | DCMC482T350CE2B | 29.6 | 10.7 | 2 1/2 x 5 1/8 |
| 5400 | DCMC542T350CF2B | 26.2 | 11.9 | 2 1/2 x 5 5/8 |
| 5500 | DCMC552T350DC2B | 34.7 | 10.8 | 3 x 4 1/8 |
| 6300 | DCMC632T350DD2B | 29.6 | 12.2 | 3 x 4 5/8 |

Type DCMC 85 °C High Capacitance, Screw Terminal, Aluminum

Highest Capacitance Screw Terminal Type

| Cap. (µF) | Catalog Part Number | ESR Max. @ 25 °C 120 Hz (mΩ) | Ripple Max. @ 85°C 120 Hz (A) | Nominal Size D x L (inches) | Cap. (µF) | Catalog Part Number | ESR Max. @ 25 °C 120 Hz (mΩ) | Ripple Max. @ 85°C 120 Hz (A) | Nominal Size D x L (inches) |
|--------------------------------|---------------------|------------------------------|-------------------------------|-----------------------------|--------------------------------|---------------------|------------------------------|-------------------------------|-----------------------------|
| 7200 | DCMC722T350DE2B | 25.8 | 13.4 | 3 x 5 1/8 | 5300 | DCMC532T400DD2B | 31.5 | 11.8 | 3 x 4 5/8 |
| 7700 | DCMC772T350FC2D | 29.9 | 12.8 | 3 1/2 x 4 1/8 | 6000 | DCMC602T400DE2B | 27.4 | 13.0 | 3 x 5 1/8 |
| 8200 | DCMC822T350DF2B | 22.9 | 14.9 | 3 x 5 5/8 | 6400 | DCMC642T400FC2D | 31.9 | 12.4 | 3 1/2 x 4 1/8 |
| 8400 | DCMC842T350DP2B | 21.7 | 17.2 | 3 x 5 7/8 | 6800 | DCMC682T400DF2B | 24.4 | 14.4 | 3 x 5 5/8 |
| 8800 | DCMC882T350FD2D | 25.7 | 13.8 | 3 1/2 x 4 5/8 | 7100 | DCMC712T400DP2B | 23.1 | 16.7 | 3 x 5 7/8 |
| 10000 | DCMC103T350FE2D | 22.5 | 15.3 | 3 1/2 x 5 1/8 | 7400 | DCMC742T400FD2D | 27.4 | 13.4 | 3 1/2 x 4 5/8 |
| 11000 | DCMC113T350DN2B | 17.1 | 19.1 | 3 x 7 5/8 | 8400 | DCMC842T400FE2D | 23.9 | 14.8 | 3 1/2 x 5 1/8 |
| 11000 | DCMC113T350FF2D | 20.0 | 16.7 | 3 1/2 x 5 5/8 | 9400 | DCMC942T400FF2D | 21.2 | 16.2 | 3 1/2 x 5 5/8 |
| 12000 | DCMC123T350FP2D | 18.9 | 17.7 | 3 1/2 x 5 7/8 | 9600 | DCMC962T400DN2B | 18.2 | 18.6 | 3 x 7 5/8 |
| 13000 | DCMC133T350DG2B | 14.2 | 20.7 | 3 x 8 5/8 | 9900 | DCMC992T400FP2D | 20.1 | 17.2 | 3 1/2 x 5 7/8 |
| 16000 | DCMC163T350FN2D | 14.9 | 22.3 | 3 1/2 x 7 5/8 | 11000 | DCMC113T400DG2B | 15.1 | 20.1 | 3 x 8 5/8 |
| 18000 | DCMC183T350FG2D | 12.4 | 24.8 | 3 1/2 x 8 5/8 | 13000 | DCMC133T400FN2D | 15.8 | 21.7 | 3 1/2 x 7 5/8 |
| 400 Vdc (450 Vdc Surge) | | | | | 450 Vdc (500 Vdc Surge) | | | | |
| 180 | DCMC181T400AK2B | 652.4 | 1.1 | 1 3/8 x 1 5/8 | 150 | DCMC151T450AK2B | 796.7 | 1.0 | 1 3/8 x 1 5/8 |
| 350 | DCMC351T400AA2B | 408.2 | 1.6 | 1 3/8 x 2 1/8 | 270 | DCMC271T450AA2B | 437.7 | 1.5 | 1 3/8 x 2 1/8 |
| 420 | DCMC421T400AH2B | 272.6 | 2.1 | 1 3/8 x 2 5/8 | 350 | DCMC351T450AH2B | 337.1 | 1.8 | 1 3/8 x 2 5/8 |
| 570 | DCMC571T400AB2B | 204.8 | 2.5 | 1 3/8 x 3 1/8 | 460 | DCMC461T450EA2B | 264.2 | 2.2 | 1 3/4 x 2 1/8 |
| 630 | DCMC631T400EA2B | 189.5 | 2.8 | 1 3/4 x 2 1/8 | 470 | DCMC471T450AB2B | 253.2 | 2.4 | 1 3/8 x 3 1/8 |
| 710 | DCMC711T400AJ2B | 164.3 | 3.1 | 1 3/8 x 3 5/8 | 560 | DCMC561T450AJ2B | 203.0 | 2.8 | 1 3/8 x 3 5/8 |
| 760 | DCMC761T400EH2B | 173.7 | 3.2 | 1 3/4 x 2 5/8 | 570 | DCMC571T450EH2B | 213.1 | 2.9 | 1 3/4 x 2 5/8 |
| 820 | DCMC821T400BA2B | 179.3 | 3.2 | 2 x 2 1/8 | 590 | DCMC591T450BA2B | 228.4 | 2.9 | 2 x 2 1/8 |
| 850 | DCMC851T400AC2B | 137.3 | 3.8 | 1 3/8 x 4 1/8 | 680 | DCMC681T450AC2B | 169.5 | 3.4 | 1 3/8 x 4 1/8 |
| 1000 | DCMC102T400AD2B | 118.0 | 3.4 | 1 3/8 x 4 5/8 | 740 | DCMC741T450EB2B | 164.5 | 2.8 | 1 3/4 x 3 1/8 |
| 1000 | DCMC102T400EB2B | 134.0 | 3.4 | 1 3/4 x 3 1/8 | 780 | DCMC781T450BH2B | 178.0 | 2.9 | 2 x 2 5/8 |
| 1000 | DCMC102T400BH2B | 141.7 | 3.5 | 2 x 2 5/8 | 820 | DCMC821T450AD2B | 145.6 | 3.5 | 1 3/8 x 4 5/8 |
| 1100 | DCMC112T400AE2B | 104.6 | 4.3 | 1 3/8 x 5 1/8 | 920 | DCMC921T450EJ2B | 130.9 | 3.8 | 1 3/4 x 3 5/8 |
| 1200 | DCMC122T400AF2B | 92.4 | 4.8 | 1 3/8 x 5 5/8 | 930 | DCMC931T450AE2B | 127.7 | 4.1 | 1 3/8 x 5 1/8 |
| 1200 | DCMC122T400EJ2B | 106.6 | 4.6 | 1 3/4 x 3 5/8 | 1000 | DCMC102T450AF2B | 113.9 | 4.5 | 1 3/8 x 5 5/8 |
| 1300 | DCMC132T400BB2B | 108.9 | 4.8 | 2 x 3 1/8 | 1000 | DCMC102T450BB2B | 137.0 | 4.3 | 2 x 3 1/8 |
| 1500 | DCMC152T400EC2B | 85.8 | 5.6 | 1 3/4 x 4 1/8 | 1100 | DCMC112T450EC2B | 107.4 | 5.0 | 1 3/4 x 4 1/8 |
| 1600 | DCMC162T400BJ2B | 85.0 | 4.3 | 2 x 3 5/8 | 1200 | DCMC122T450BJ2B | 109.0 | 3.8 | 2 x 3 5/8 |
| 1700 | DCMC172T400ED2B | 74.3 | 4.9 | 1 3/4 x 4 5/8 | 1200 | DCMC122T450CH2B | 115.8 | 4.0 | 2 1/2 x 2 5/8 |
| 1700 | DCMC172T400CH2B | 93.1 | 4.7 | 2 1/2 x 2 5/8 | 1300 | DCMC132T450ED2B | 91.1 | 4.7 | 1 3/4 x 4 5/8 |
| 1900 | DCMC192T400BC2B | 69.8 | 5.7 | 2 x 4 1/8 | 1500 | DCMC152T450EE2B | 79.2 | 5.4 | 1 3/4 x 5 1/8 |
| 2000 | DCMC202T400EE2B | 63.4 | 6.3 | 1 3/4 x 5 1/8 | 1500 | DCMC152T450BC2B | 89.5 | 5.3 | 2 x 4 1/8 |
| 2100 | DCMC212T400CB2B | 65.3 | 6.4 | 2 1/2 x 3 1/8 | 1700 | DCMC172T450EF2B | 70.2 | 6.2 | 1 3/4 x 5 5/8 |
| 2200 | DCMC222T400EF2B | 57.3 | 7.1 | 1 3/4 x 5 5/8 | 1700 | DCMC172T450CB2B | 81.1 | 6.0 | 2 1/2 x 3 1/8 |
| 2300 | DCMC232T400BD2B | 59.3 | 7.2 | 2 x 4 5/8 | 1800 | DCMC182T450BD2B | 76.0 | 6.4 | 2 x 4 5/8 |
| 2600 | DCMC262T400BE2B | 52.2 | 6.8 | 2 x 5 1/8 | 1900 | DCMC192T450BE2B | 66.8 | 6.0 | 2 x 5 1/8 |
| 2600 | DCMC262T400CJ2B | 52.0 | 7.2 | 2 1/2 x 3 5/8 | 2000 | DCMC202T450CJ2B | 66.5 | 6.4 | 2 1/2 x 3 5/8 |
| 2900 | DCMC292T400BF2B | 45.9 | 8.1 | 2 x 5 5/8 | 2200 | DCMC222T450BF2B | 58.6 | 7.1 | 2 x 5 5/8 |
| 3100 | DCMC312T400CC2B | 42.8 | 8.7 | 2 1/2 x 4 1/8 | 2400 | DCMC242T450CC2B | 54.7 | 7.7 | 2 1/2 x 4 1/8 |
| 3200 | DCMC322T400DB2B | 57.5 | 7.8 | 3 x 3 1/8 | 2500 | DCMC252T450DB2B | 65.7 | 7.3 | 3 x 3 1/8 |
| 3900 | DCMC392T400CD2B | 35.6 | 10.3 | 2 1/2 x 4 5/8 | 2800 | DCMC282T450CD2B | 46.4 | 9.0 | 2 1/2 x 4 5/8 |
| 3900 | DCMC392T400DJ2B | 44.9 | 9.4 | 3 x 3 5/8 | 3000 | DCMC302T450DJ2B | 52.2 | 8.7 | 3 x 3 5/8 |
| 4000 | DCMC402T400CE2B | 31.7 | 10.3 | 2 1/2 x 5 1/8 | 3300 | DCMC332T450CE2B | 40.4 | 9.2 | 2 1/2 x 5 1/8 |
| 4700 | DCMC472T400CF2B | 28.1 | 11.5 | 2 1/2 x 5 5/8 | 3900 | DCMC392T450CF2B | 35.4 | 10.3 | 2 1/2 x 5 5/8 |
| 4700 | DCMC472T400DC2B | 37.0 | 10.5 | 3 x 4 1/8 | | | | | |

Type DCMC 85 °C High Capacitance, Screw Terminal, Aluminum

Highest Capacitance Screw Terminal Type

| Cap. (µF) | Catalog Part Number | ESR Max. @ 25 °C 120 Hz (mΩ) | Ripple Max. @ 85°C 120 Hz (A) | Nominal Size D x L (inches) |
|--------------------------------|---------------------|------------------------------|-------------------------------|-----------------------------|
| 3900 | DCMC392T450DC2B | 40.1 | 10.1 | 3 x 4 1/8 |
| 4100 | DCMC412T450DD2B | 37.5 | 10.8 | 3 x 4 5/8 |
| 4700 | DCMC472T450DE2B | 32.5 | 12.0 | 3 x 5 1/8 |
| 5000 | DCMC502T450FC2D | 31.8 | 12.5 | 3 1/2 x 4 1/8 |
| 5600 | DCMC562T450DF2B | 28.8 | 13.3 | 3 x 5 5/8 |
| 5800 | DCMC582T450DP2B | 27.3 | 15.4 | 3 x 5 7/8 |
| 5800 | DCMC582T450FD2D | 27.0 | 13.5 | 3 1/2 x 4 5/8 |
| 6800 | DCMC682T450FE2D | 23.5 | 15.0 | 3 1/2 x 5 1/8 |
| 7300 | DCMC732T450FF2D | 21.1 | 16.3 | 3 1/2 x 5 5/8 |
| 7700 | DCMC772T450FP2D | 20.0 | 17.2 | 3 1/2 x 5 7/8 |
| 7900 | DCMC792T450DN2B | 21.3 | 17.1 | 3 x 7 5/8 |
| 9000 | DCMC902T450DG2B | 17.6 | 18.6 | 3 x 8 5/8 |
| 10000 | DCMC103T450FN2D | 15.9 | 21.6 | 3 1/2 x 7 5/8 |
| 12000 | DCMC123T450FG2D | 13.3 | 24.0 | 3 1/2 x 8 5/8 |
| 500 Vdc (550 Vdc Surge) | | | | |
| 110 | DCMC111T500AK2B | 1224.3 | 0.8 | 1 3/8 x 1 5/8 |
| 180 | DCMC181T500AA2B | 736.9 | 1.2 | 1 3/8 x 2 1/8 |
| 240 | DCMC241T500AH2B | 556.5 | 1.4 | 1 3/8 x 2 5/8 |
| 270 | DCMC271T500EA2B | 498.4 | 1.6 | 1 3/4 x 2 1/8 |
| 320 | DCMC321T500AB2B | 409.7 | 1.9 | 1 3/8 x 3 1/8 |
| 340 | DCMC341T500BA2B | 393.1 | 2.0 | 2 x 2 1/8 |
| 380 | DCMC381T500EH2B | 347.2 | 2.2 | 1 3/4 x 2 5/8 |
| 400 | DCMC401T500AJ2B | 338.1 | 2.4 | 1 3/8 x 3 5/8 |
| 470 | DCMC471T500BH2B | 273.9 | 2.7 | 2 x 2 5/8 |
| 480 | DCMC481T500AC2B | 293.2 | 2.1 | 1 3/8 x 4 1/8 |
| 500 | DCMC501T500EB2B | 264.5 | 2.4 | 1 3/4 x 3 1/8 |
| 560 | DCMC561T500AD2B | 261.2 | 2.6 | 1 3/8 x 4 5/8 |
| 640 | DCMC641T500AE2B | 231.1 | 2.9 | 1 3/8 x 5 1/8 |
| 650 | DCMC651T500EJ2B | 202.0 | 3.2 | 1 3/4 x 3 5/8 |
| 700 | DCMC701T500BB2B | 200.1 | 3.4 | 2 x 3 1/8 |
| 720 | DCMC721T500AF2B | 195.4 | 3.6 | 1 3/8 x 5 5/8 |
| 790 | DCMC791T500EC2B | 172.4 | 3.9 | 1 3/4 x 4 1/8 |
| 800 | DCMC801T500CH2B | 170.6 | 3.0 | 2 1/2 x 2 5/8 |
| 860 | DCMC861T500BJ2B | 159.1 | 3.4 | 2 x 3 5/8 |
| 930 | DCMC931T500ED2B | 149.1 | 3.7 | 1 3/4 x 4 5/8 |
| 1000 | DCMC102T500BC2B | 138.7 | 4.1 | 2 x 4 1/8 |
| 1100 | DCMC112T500EE2B | 129.6 | 4.4 | 1 3/4 x 5 1/8 |

| Cap. (µF) | Catalog Part Number | ESR Max. @ 25 °C 120 Hz (mΩ) | Ripple Max. @ 85°C 120 Hz (A) | Nominal Size D x L (inches) |
|--------------------------------|---------------------|------------------------------|-------------------------------|-----------------------------|
| 1100 | DCMC112T500CB2B | 122.0 | 4.7 | 2 1/2 x 3 1/8 |
| 1200 | DCMC122T500EF2B | 114.7 | 5.0 | 1 3/4 x 5 5/8 |
| 1200 | DCMC122T500BD2B | 117.7 | 5.1 | 2 x 4 5/8 |
| 1400 | DCMC142T500BE2B | 102.3 | 4.8 | 2 x 5 1/8 |
| 1400 | DCMC142T500CJ2B | 95.1 | 5.3 | 2 1/2 x 3 5/8 |
| 1500 | DCMC152T500BF2B | 93.3 | 5.7 | 2 x 5 5/8 |
| 1700 | DCMC172T500CC2B | 79.7 | 6.4 | 2 1/2 x 4 1/8 |
| 1700 | DCMC172T500DB2B | 86.4 | 6.4 | 3 x 3 1/8 |
| 2100 | DCMC212T500CE2B | 61.1 | 7.8 | 2 1/2 x 5 1/8 |
| 2200 | DCMC222T500CD2B | 68.3 | 7.6 | 2 1/2 x 4 5/8 |
| 2200 | DCMC222T500DJ2B | 67.4 | 7.1 | 3 x 3 5/8 |
| 2500 | DCMC252T500CF2B | 54.7 | 8.3 | 2 1/2 x 5 5/8 |
| 2500 | DCMC252T500DC2B | 55.4 | 8.6 | 3 x 4 1/8 |
| 3000 | DCMC302T500DD2B | 48.1 | 9.5 | 3 x 4 5/8 |
| 3400 | DCMC342T500DE2B | 43.1 | 10.4 | 3 x 5 1/8 |
| 3500 | DCMC352T500FC2D | 40.1 | 11.1 | 3 1/2 x 4 1/8 |
| 3900 | DCMC392T500DF2B | 37.5 | 11.6 | 3 x 5 5/8 |
| 4100 | DCMC412T500DP2B | 35.5 | 13.5 | 3 x 5 7/8 |
| 4100 | DCMC412T500FD2D | 34.1 | 12.0 | 3 1/2 x 4 5/8 |
| 4800 | DCMC482T500FE2D | 30.0 | 13.2 | 3 1/2 x 5 1/8 |
| 5400 | DCMC542T500FF2D | 28.0 | 14.2 | 3 1/2 x 5 5/8 |
| 5700 | DCMC572T500FP2D | 26.0 | 15.1 | 3 1/2 x 5 7/8 |
| 5700 | DCMC572T500DN2B | 27.9 | 15.0 | 3 x 7 5/8 |
| 6600 | DCMC662T500DG2B | 23.1 | 16.2 | 3 x 8 5/8 |
| 7900 | DCMC792T500FN2D | 20.5 | 19.1 | 3 1/2 x 7 5/8 |
| 9200 | DCMC922T500FG2D | 16.7 | 21.4 | 3 1/2 x 8 5/8 |
| 550 Vdc (600 Vdc Surge) | | | | |
| 1400 | DCMC142T550CC2B | 170.5 | 4.9 | 2 1/2 x 4 1/8 |
| 1700 | DCMC172T550CD2B | 132.6 | 5.9 | 2 1/2 x 4 5/8 |
| 1900 | DCMC192T550CE2B | 111.7 | 6.8 | 2 1/2 x 5 1/8 |
| 2200 | DCMC222T550DC2B | 90.4 | 7.8 | 3 x 4 1/8 |
| 2300 | DCMC232T550CF2B | 86.5 | 7.8 | 2 1/2 x 5 5/8 |
| 2500 | DCMC252T550DD2B | 79.6 | 8.4 | 3 x 4 5/8 |
| 2900 | DCMC292T550DE2B | 64.0 | 9.7 | 3 x 5 1/8 |
| 3400 | DCMC342T550DF2B | 54.6 | 10.9 | 3 x 5 5/8 |
| 3700 | DCMC372T550DP2B | 50.2 | 12.2 | 3 x 5 7/8 |
| 5100 | DCMC512T550DN2B | 36.4 | 16.2 | 3 x 7 5/8 |

Type DCMC 85 °C High Capacitance, Screw Terminal, Aluminum

Highest Capacitance Screw Terminal Type

Typical Performance Curves

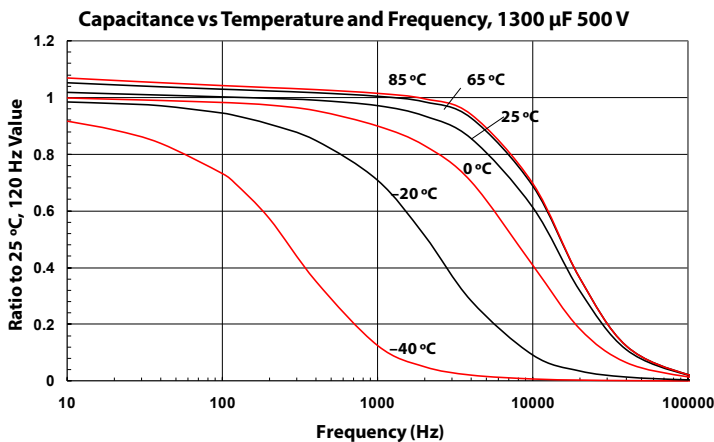

Type DCMC 85 °C High Capacitance, Screw Terminal, Aluminum

Highest Capacitance Screw Terminal Type

Typical Performance Curves

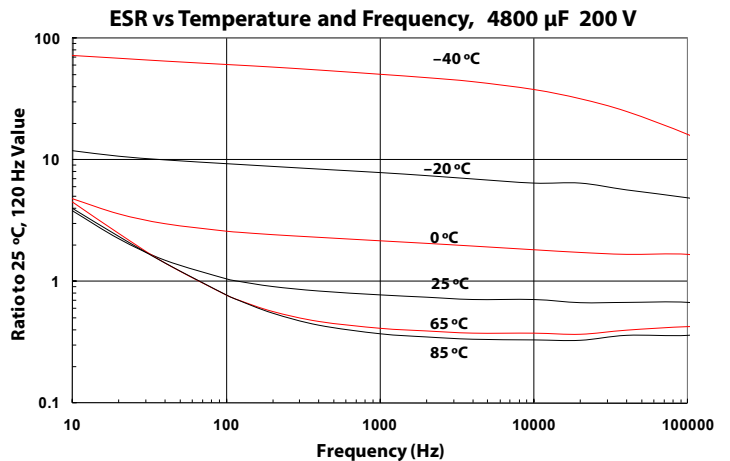
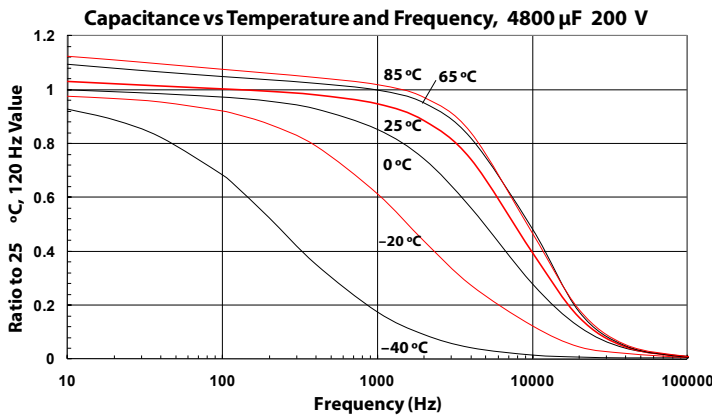
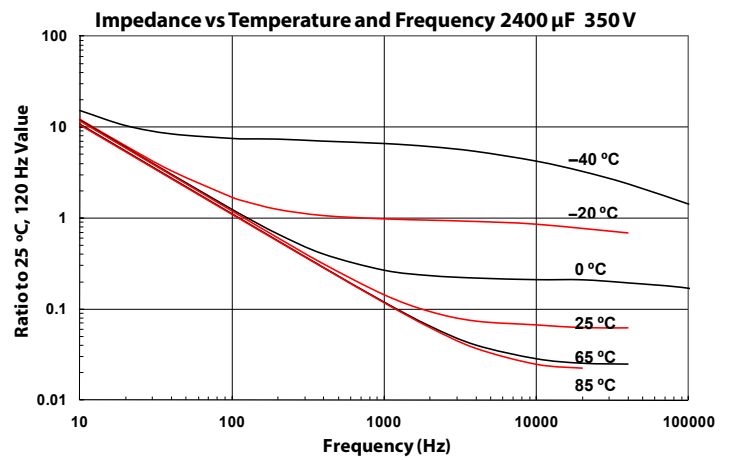
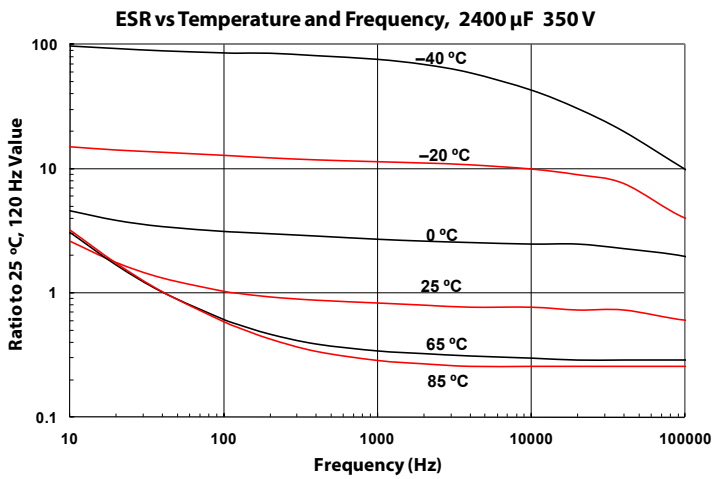

Type DCMC 85 °C High Capacitance, Screw Terminal, Aluminum

Highest Capacitance Screw Terminal Type

Typical Performance Curves

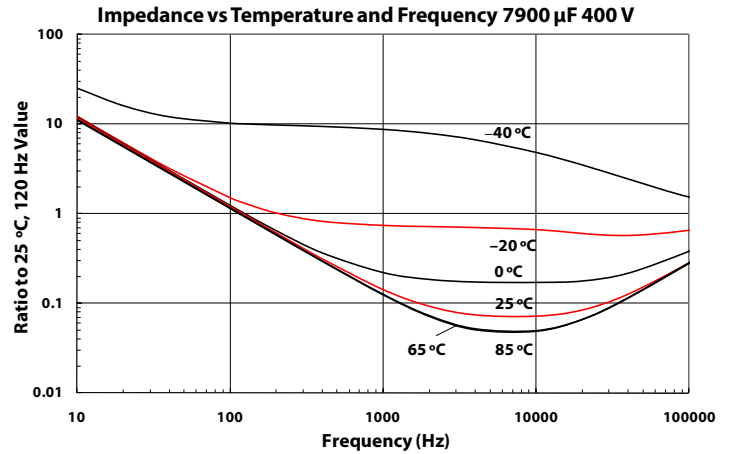
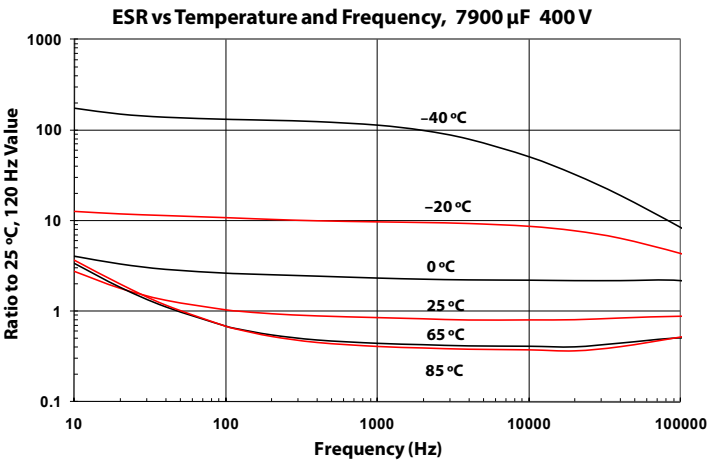

Notice and Disclaimer: All product drawings, descriptions, specifications, statements, information and data (collectively, the "Information") in this datasheet or other publication are subject to change. The customer is responsible for checking, confirming and verifying the extent to which the Information contained in this datasheet or other publication is applicable to an order at the time the order is placed. All Information given herein is believed to be accurate and reliable, but it is presented without any guarantee, warranty, representation or responsibility of any kind, expressed or implied. Statements of suitability for certain applications are based on the knowledge that the Cornell Dubilier company providing such statements ("Cornell Dubilier") has of operating conditions that such Cornell Dubilier company regards as typical for such applications, but are not intended to constitute any guarantee, warranty or representation regarding any such matter – and Cornell Dubilier specifically and expressly disclaims any guarantee, warranty or representation concerning the suitability for a specific customer application, use, storage, transportation, or operating environment. The Information is intended for use only by customers who have the requisite experience and capability to determine the correct products for their application. Any technical advice inferred from this Information or otherwise provided by Cornell Dubilier with reference to the use of any Cornell Dubilier products is given gratis (unless otherwise specified by Cornell Dubilier), and Cornell Dubilier assumes no obligation or liability for the advice given or results obtained. Although Cornell Dubilier strives to apply the most stringent quality and safety standards regarding the design and manufacturing of its products, in light of the current state of the art, isolated component failures may still occur. Accordingly, customer applications which require a high degree of reliability or safety should employ suitable designs or other safeguards (such as installation of protective circuitry or redundancies or other appropriate protective measures) in order to ensure that the failure of an electrical component does not result in a risk of personal injury or property damage. Although all product-related warnings, cautions and notes must be observed, the customer should not assume that all safety measures are indicated in such warnings, cautions and notes, or that other safety measures may not be required.