

# MC78LXXA / LM78LXXA

## 3-Terminal 0.1 A Positive Voltage Regulator

### Features

- Maximum Output Current of 100 mA
- Output Voltage of 5 V, 6 V, 8 V, 12 V, and 15 V
- Thermal Overload Protection
- Short-Circuit Current Limiting
- Output Voltage Offered in  $\pm 5\%$  Tolerance

### Description

The MC78LXXA / LM78LXXA series of fixed-voltage monolithic integrated circuit voltage regulators are suitable for applications that required supply current up to 100 mA.

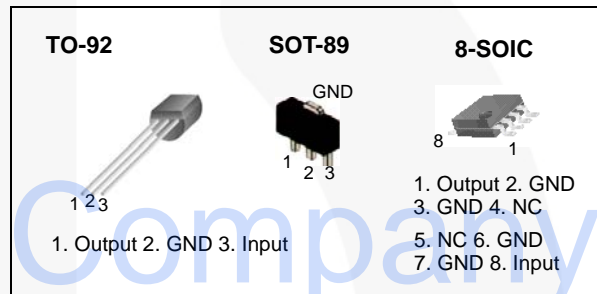

### Ordering Information

Product Number	Package	Packing Method	Output Voltage Tolerance	Operating Temperature
LM78L05ACZ	TO-92	Bulk	$\pm 5\%$	0 to +125°C
LM78L05ACZX		Tape & Reel		
LM78L05ACZXA		Ammo		
LM78L12ACZ		Bulk		
LM78L12ACZX		Tape & Reel		
MC78L05ACP		Bulk		
MC78L05ACPXA		Ammo		
MC78L06ACP		Bulk		
MC78L08ACP		Bulk		
MC78L15ACP		Bulk		
MC78L15ACPXA		Ammo		
MC78L05ACD		8-SOIC		
MC78L05ACDX	Tape & Reel			
MC78L05ACHX	SOT-89	Tape & Reel		
MC78L08ACHX		Tape & Reel		

### Block Diagram

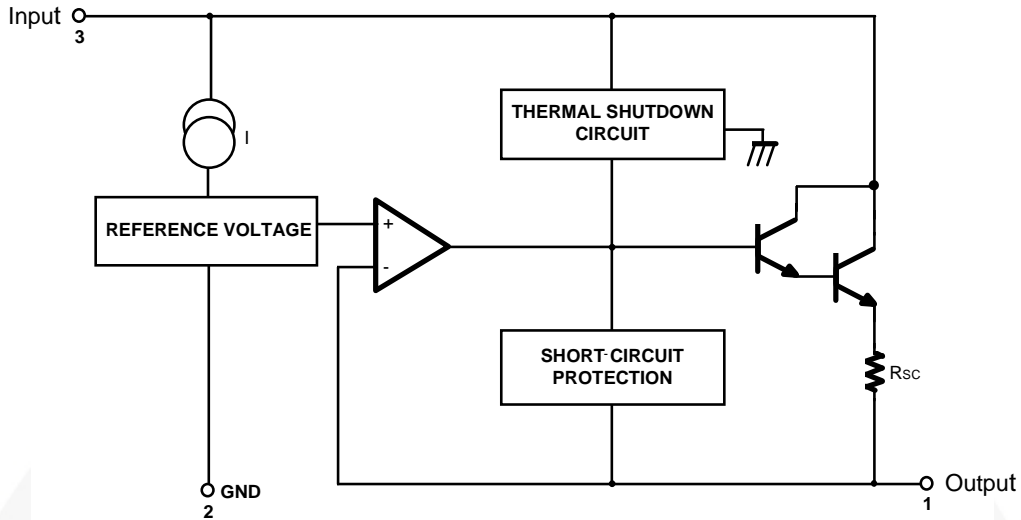

Figure 1. Block Diagram

### Absolute Maximum Ratings

Stresses exceeding the absolute maximum ratings may damage the device. The device may not function or be operable above the recommended operating conditions and stressing the parts to these levels is not recommended. In addition, extended exposure to stresses above the recommended operating conditions may affect device reliability. The absolute maximum ratings are stress ratings only. Values are at  $T_A = 25^\circ\text{C}$  unless otherwise noted.

Symbol	Parameter		Value	Unit
$V_I$	Input Voltage	$V_O = 5\text{ V to }8\text{ V}$	30	V
		$V_O = 12\text{ V to }15\text{ V}$	35	V
$T_J$	Operating Junction Temperature Range		0 to +150	$^\circ\text{C}$
$T_{STG}$	Storage Temperature Range		-65 to +150	$^\circ\text{C}$
$R_{\theta JC}$	Thermal Resistance, Junction-Case	TO-92	50	$^\circ\text{C/W}$
$R_{\theta JA}$	Thermal Resistance, Junction-Air	TO-92	150	$^\circ\text{C/W}$
		SOT-89	225	$^\circ\text{C/W}$
		8-SOIC	160	$^\circ\text{C/W}$

## Electrical Characteristics (MC78L05A / LM78L05A)

$V_I = 10\text{ V}$ ,  $I_O = 40\text{ mA}$ ,  $0^\circ\text{C} \leq T_J \leq 125^\circ\text{C}$ ,  $C_I = 0.33\text{ }\mu\text{F}$ ,  $C_O = 0.1\text{ }\mu\text{F}$ , unless otherwise specified.

Symbol	Parameter	Conditions	Min.	Typ.	Max.	Unit	
$V_O$	Output Voltage	$T_J = 25^\circ\text{C}$	4.8	5.0	5.2	V	
$\Delta V_O$	Line Regulation <sup>(1)</sup>	$T_J = 25^\circ\text{C}$	$7\text{ V} \leq V_I \leq 20\text{ V}$		8	150	mV
			$8\text{ V} \leq V_I \leq 20\text{ V}$		6	100	mV
$\Delta V_O$	Load Regulation <sup>(1)</sup>	$T_J = 25^\circ\text{C}$	$1\text{ mA} \leq I_O \leq 100\text{ mA}$		11	60	mV
			$1\text{ mA} \leq I_O \leq 40\text{ mA}$		5.0	30.0	mV
$V_O$	Output Voltage	$7\text{ V} \leq V_I \leq 20\text{ V}$	$1\text{ mA} \leq I_O \leq 40\text{ mA}$			5.25	V
		$7\text{ V} \leq V_I \leq V_{MAX}^{(2)}$	$1\text{ mA} \leq I_O \leq 70\text{ mA}$	4.75		5.25	V
$I_Q$	Quiescent Current	$T_J = 25^\circ\text{C}$		2.0	5.5	mA	
$\Delta I_Q$	Quiescent Current Change	With Line	$8\text{ V} \leq V_I \leq 20\text{ V}$			1.5	mA
$\Delta I_Q$		With Load	$1\text{ mA} \leq I_O \leq 40\text{ mA}$			0.1	mA
$V_N$	Output Noise Voltage	$T_A = 25^\circ\text{C}$ , $10\text{ Hz} \leq f \leq 100\text{ kHz}$		40		$\mu\text{V}/V_O$	
$\Delta V_O/\Delta T$	Temperature Coefficient of $V_O$	$I_O = 5\text{ mA}$		-0.65		$\text{mV}/^\circ\text{C}$	
RR	Ripple Rejection	$f = 120\text{ Hz}$ , $8\text{ V} \leq V_I \leq 18\text{ V}$ , $T_J = 25^\circ\text{C}$	41	80		dB	
$V_D$	Dropout Voltage	$T_J = 25^\circ\text{C}$		1.7		V	

### Notes:

- The maximum steady-state usable output current and input voltage are very dependent on the heat sinking and/or lead length of the package. The data above represents pulse test conditions with junction temperature as indicated at the initiation of tests.
- Power dissipation  $P_D \leq 0.75\text{ W}$ .

## Electrical Characteristics (MC78L06A)

$V_I = 12\text{ V}$ ,  $I_O = 40\text{ mA}$ ,  $0^\circ\text{C} \leq T_J \leq 125^\circ\text{C}$ ,  $C_I = 0.33\ \mu\text{F}$ ,  $C_O = 0.1\ \mu\text{F}$ , unless otherwise specified.

Symbol	Parameter	Conditions	Min.	Typ.	Max.	Unit	
$V_O$	Output Voltage	$T_J = 25^\circ\text{C}$	5.75	6.0	6.25	V	
$\Delta V_O$	Line Regulation <sup>(3)</sup>	$T_J = 25^\circ\text{C}$	$8.5\text{ V} \leq V_I \leq 20\text{ V}$		64	175	mV
			$9\text{ V} \leq V_I \leq 20\text{ V}$		54	125	mV
$\Delta V_O$	Load Regulation <sup>(3)</sup>	$T_J = 25^\circ\text{C}$	$1\text{ mA} \leq I_O \leq 100\text{ mA}$		12.8	80.0	mV
			$1\text{ mA} \leq I_O \leq 70\text{ mA}$		5.8	40.0	mV
$V_O$	Output Voltage	$8.5\text{ V} \leq V_I \leq 20\text{ V}$ , $1\text{ mA} \leq I_O \leq 40\text{ mA}$	5.7		6.3	V	
		$8.5\text{ V} \leq V_I \leq V_{\text{MAX}}^{(4)}$ , $1\text{ mA} \leq I_O \leq 70\text{ mA}$	5.7		6.3	V	
$I_Q$	Quiescent Current	$T_J = 25^\circ\text{C}$			5.5	mA	
		$T_J = 125^\circ\text{C}$		3.9	6.0	mA	
$\Delta I_Q$	Quiescent Current Change	With Line	$9\text{ V} \leq V_I \leq 20\text{ V}$			1.5	mA
$\Delta I_Q$		With Load	$1\text{ mA} \leq I_O \leq 40\text{ mA}$			0.1	mA
$V_N$	Output Noise Voltage	$T_A = 25^\circ\text{C}$ , $10\text{ Hz} \leq f \leq 100\text{ kHz}$		40		$\mu\text{V}/V_O$	
$\Delta V_O/\Delta T$	Temperature Coefficient of $V_O$	$I_O = 5\text{ mA}$		0.75		$\text{mV}/^\circ\text{C}$	
RR	Ripple Rejection	$f = 120\text{ Hz}$ , $10\text{ V} \leq V_I \leq 20\text{ V}$ , $T_J = 25^\circ\text{C}$	40	46		dB	
$V_D$	Dropout Voltage	$T_J = 25^\circ\text{C}$		1.7		V	

### Notes:

- The maximum steady-state usable output current and input voltage are very dependent on the heat sinking and/or lead length of the package. The data above represents pulse test conditions with junction temperature as indicated at the initiation of tests.
- Power dissipation  $P_D \leq 0.75\text{ W}$ .

## Electrical Characteristics (MC78L08A)

$V_I = 14\text{ V}$ ,  $I_O = 40\text{ mA}$ ,  $0^\circ\text{C} \leq T_J \leq 125^\circ\text{C}$ ,  $C_I = 0.33\ \mu\text{F}$ ,  $C_O = 0.1\ \mu\text{F}$ , unless otherwise specified.

Symbol	Parameter	Conditions	Min.	Typ.	Max.	Unit	
$V_O$	Output Voltage	$T_J = 25^\circ\text{C}$	7.7	8.0	8.3	V	
$\Delta V_O$	Line Regulation <sup>(5)</sup>	$T_J = 25^\circ\text{C}$	$10.5\text{ V} \leq V_I \leq 23\text{ V}$		10	175	mV
			$11\text{ V} \leq V_I \leq 23\text{ V}$		8	125	mV
$\Delta V_O$	Load Regulation <sup>(5)</sup>	$T_J = 25^\circ\text{C}$	$1\text{ mA} \leq I_O \leq 100\text{ mA}$		15	80	mV
			$1\text{ mA} \leq I_O \leq 40\text{ mA}$		8	40	mV
$V_O$	Output Voltage	$10.5\text{V} \leq V_I \leq 23\text{V}$	$1\text{ mA} \leq I_O \leq 40\text{ mA}$	7.6		8.4	V
		$10.5\text{V} \leq V_I \leq V_{\text{MAX}}^{(6)}$	$1\text{ mA} \leq I_O \leq 70\text{ mA}$	7.6		8.4	V
$I_Q$	Quiescent Current	$T_J = 25^\circ\text{C}$		2.0	5.5	mA	
$\Delta I_Q$	Quiescent Current Change	With Line	$11\text{ V} \leq V_I \leq 23\text{ V}$			1.5	mA
$\Delta I_Q$		With Load	$1\text{ mA} \leq I_O \leq 40\text{ mA}$			0.1	mA
$V_N$	Output Noise Voltage	$T_A = 25^\circ\text{C}$ , $10\text{ Hz} \leq f \leq 100\text{ kHz}$		60		$\mu\text{V}/V_O$	
$\Delta V_O/\Delta T$	Temperature Coefficient of $V_O$	$I_O = 5\text{ mA}$		-0.8		$\text{mV}/^\circ\text{C}$	
RR	Ripple Rejection	$f = 120\text{ Hz}$ , $11\text{ V} \leq V_I \leq 21\text{ V}$ , $T_J = 25^\circ\text{C}$	39	70		dB	
$V_D$	Dropout Voltage	$T_J = 25^\circ\text{C}$		1.7		V	

### Notes:

- The maximum steady-state usable output current and input voltage are very dependent on the heat sinking and/or lead length of the package. The data above represents pulse test conditions with junction temperature as indicated at the initiation of tests.
- Power dissipation  $P_D \leq 0.75\text{ W}$ .

## Electrical Characteristics (MC78L12A / LM78L12A)

$V_I = 19\text{ V}$ ,  $I_O = 40\text{ mA}$ ,  $0^\circ\text{C} \leq T_J \leq 125^\circ\text{C}$ ,  $C_I = 0.33\ \mu\text{F}$ ,  $C_O = 0.1\ \mu\text{F}$ , unless otherwise specified.

Symbol	Parameter	Conditions	Min.	Typ.	Max.	Unit	
$V_O$	Output Voltage	$T_J = 25^\circ\text{C}$	11.5	12.0	12.5	V	
$\Delta V_O$	Line Regulation <sup>(7)</sup>	$T_J = 25^\circ\text{C}$	$14.5\text{ V} \leq V_I \leq 27\text{ V}$		20	250	mV
			$16\text{ V} \leq V_I \leq 27\text{ V}$		15	200	mV
$\Delta V_O$	Load Regulation <sup>(7)</sup>	$T_J = 25^\circ\text{C}$	$1\text{ mA} \leq I_O \leq 100\text{ mA}$		20	100	mV
			$1\text{ mA} \leq I_O \leq 40\text{ mA}$		10	50	mV
$V_O$	Output Voltage	$14.5\text{ V} \leq V_I \leq 27\text{ V}$	$1\text{ mA} \leq I_O \leq 40\text{ mA}$	11.4		12.6	V
		$14.5\text{ V} \leq V_I \leq V_{\text{MAX}}^{(8)}$	$1\text{ mA} \leq I_O \leq 70\text{ mA}$	11.4		12.6	V
$I_Q$	Quiescent Current	$T_J = 25^\circ\text{C}$		2.1	6.0	mA	
$\Delta I_Q$	Quiescent Current Change	With Line	$16\text{ V} \leq V_I \leq 27\text{ V}$			1.5	mA
$\Delta I_Q$		With Load	$1\text{ mA} \leq I_O \leq 40\text{ mA}$			0.1	mA
$V_N$	Output Noise Voltage	$T_A = 25^\circ\text{C}$ , $10\text{ Hz} \leq f \leq 100\text{ kHz}$		80		$\mu\text{V}/V_O$	
$\Delta V_O/\Delta T$	Temperature Coefficient of $V_O$	$I_O = 5\text{ mA}$		-1.0		$\text{mV}/^\circ\text{C}$	
RR	Ripple Rejection	$f = 120\text{ Hz}$ , $15\text{ V} \leq V_I \leq 25\text{ V}$ , $T_J = 25^\circ\text{C}$	37	65		dB	
$V_D$	Dropout Voltage	$T_J = 25^\circ\text{C}$		1.7		V	

### Notes:

- The maximum steady-state usable output current and input voltage are very dependent on the heat sinking and/or lead length of the package. The data above represents pulse test conditions with junction temperature as indicated at the initiation of tests.
- Power dissipation  $P_D \leq 0.75\text{ W}$ .

## Electrical Characteristics (MC78L15A)

$V_I = 23\text{ V}$ ,  $I_O = 40\text{ mA}$ ,  $0^\circ\text{C} \leq T_J \leq 125^\circ\text{C}$ ,  $C_I = 0.33\ \mu\text{F}$ ,  $C_O = 0.1\ \mu\text{F}$ , unless otherwise specified.

Symbol	Parameter	Conditions	Min.	Typ.	Max.	Unit
$V_O$	Output Voltage	$T_J = 25^\circ\text{C}$	14.4	15.0	15.6	V
$\Delta V_O$	Line Regulation <sup>(9)</sup>	$T_J = 25^\circ\text{C}$	$17.5\text{ V} \leq V_I \leq 30\text{ V}$	25	300	mV
			$20\text{ V} \leq V_I \leq 30\text{ V}$	20	250	mV
$\Delta V_O$	Load Regulation <sup>(9)</sup>	$T_J = 25^\circ\text{C}$	$1\text{ mA} \leq I_O \leq 100\text{ mA}$	25	150	mV
			$1\text{ mA} \leq I_O \leq 40\text{ mA}$	12	75	mV
$V_O$	Output Voltage	$17.5\text{ V} \leq V_I \leq 30\text{ V}$	$1\text{ mA} \leq I_O \leq 40\text{ mA}$	14.25	15.75	V
		$17.5\text{ V} \leq V_I \leq V_{\text{MAX}}^{(10)}$	$1\text{ mA} \leq I_O \leq 70\text{ mA}$	14.25	15.75	V
$I_Q$	Quiescent Current	$T_J = 25^\circ\text{C}$		2.1	6.0	mA
$\Delta I_Q$	Quiescent Current Change	With Line	$20\text{ V} \leq V_I \leq 30\text{ V}$		1.5	mA
$\Delta I_Q$		With Load	$1\text{ mA} \leq I_O \leq 40\text{ mA}$		0.1	mA
$V_N$	Output Noise Voltage	$T_A = 25^\circ\text{C}$ , $10\text{ Hz} \leq f \leq 100\text{ kHz}$		90		$\mu\text{V}/V_o$
$\Delta V_O/\Delta T$	Temperature Coefficient of $V_O$	$I_O = 5\text{ mA}$		-1.3		$\text{mV}/^\circ\text{C}$
RR	Ripple Rejection	$f = 120\text{ Hz}$ , $18.5\text{ V} \leq V_I \leq 28.5\text{ V}$ , $T_J = 25^\circ\text{C}$	34	60		dB
$V_D$	Dropout Voltage	$T_J = 25^\circ\text{C}$		1.7		V

### Notes:

9. The maximum steady-state usable output current and input voltage are very dependent on the heat sinking and/or lead length of the package. The data above represents pulse test conditions with junction temperature as indicated at the initiation of tests.
10. Power dissipation  $P_D \leq 0.75\text{ W}$ .

## Typical Application

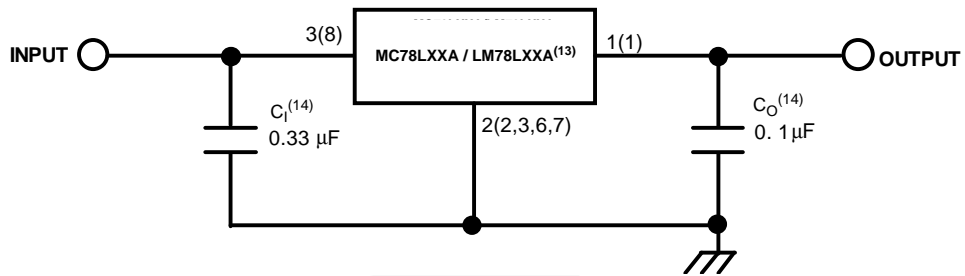

Figure 2. Typical Application

**Notes:**

- 13. To specify an output voltage, substitute voltage value for "XX".
- 14.  $C_1$  is required if the regulator is located an appreciable distance from the power supply filter. Though  $C_0$  is not needed for stability, it improves transient response. Bypass capacitors are recommended for optimum stability and transient response and should be located as close as possible to the regulator.



Physical Dimensions

SOT-89

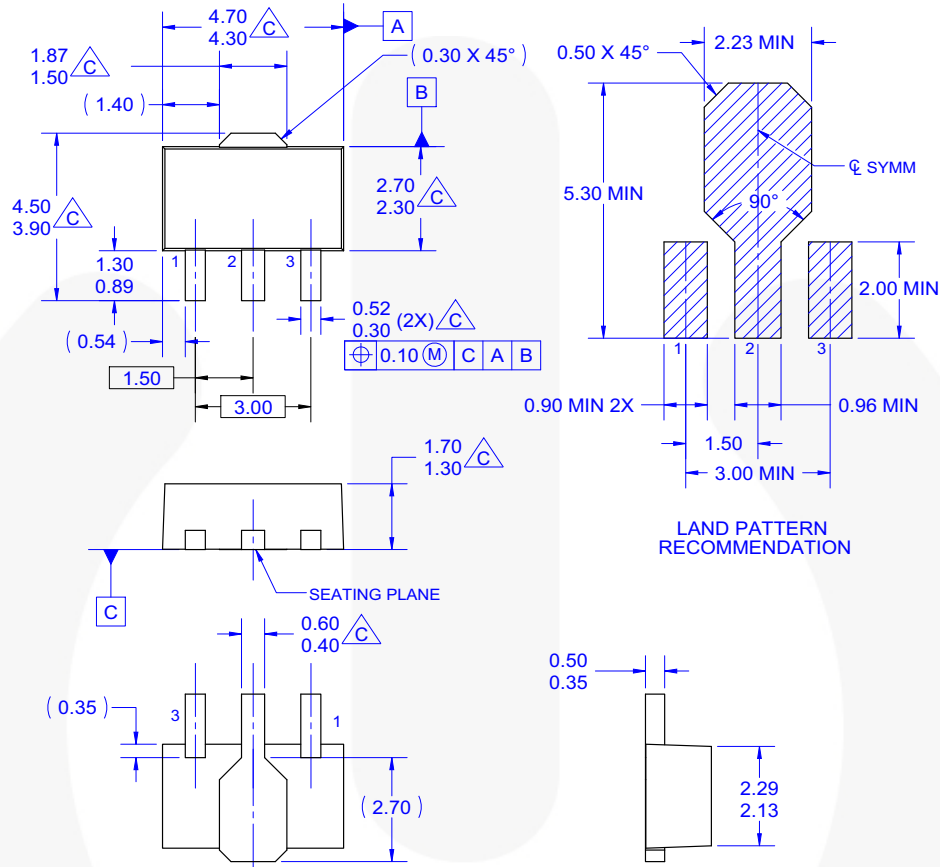

- NOTES: UNLESS OTHERWISE SPECIFIED.
- A. REFERENCE TO JEDEC TO-243 VARIATION AA.
  - B. ALL DIMENSIONS ARE IN MILLIMETERS.
  - C. DOES NOT COMPLY JEDEC STANDARD VALUE.
  - D. DIMENSIONS ARE EXCLUSIVE OF BURRS, MOLD FLASH AND TIE BAR PROTRUSION.
  - E. DIMENSION AND TOLERANCE AS PER ASME Y14.5-1994.
  - F. DRAWING FILE NAME: MA03CREV2

Figure 3. 3-Lead, SOT-89, JEDEC TO-243, Option AA

Package drawings are provided as a service to customers considering Fairchild components. Drawings may change in any manner without notice. Please note the revision and/or date on the drawing and contact a Fairchild Semiconductor representative to verify or obtain the most recent revision. Package specifications do not expand the terms of Fairchild's worldwide terms and conditions, specifically the warranty therein, which covers Fairchild products.

Always visit Fairchild Semiconductor's online packaging area for the most recent package drawings:  
<http://www.fairchildsemi.com/packaging/>.

For current tape and reel specifications, visit Fairchild Semiconductor's online packaging area:  
[http://www.fairchildsemi.com/packaging/tr/sot89\\_tr.pdf](http://www.fairchildsemi.com/packaging/tr/sot89_tr.pdf).

Physical Dimensions (Continued)

TO-92 Straight Lead for Bulk Packing

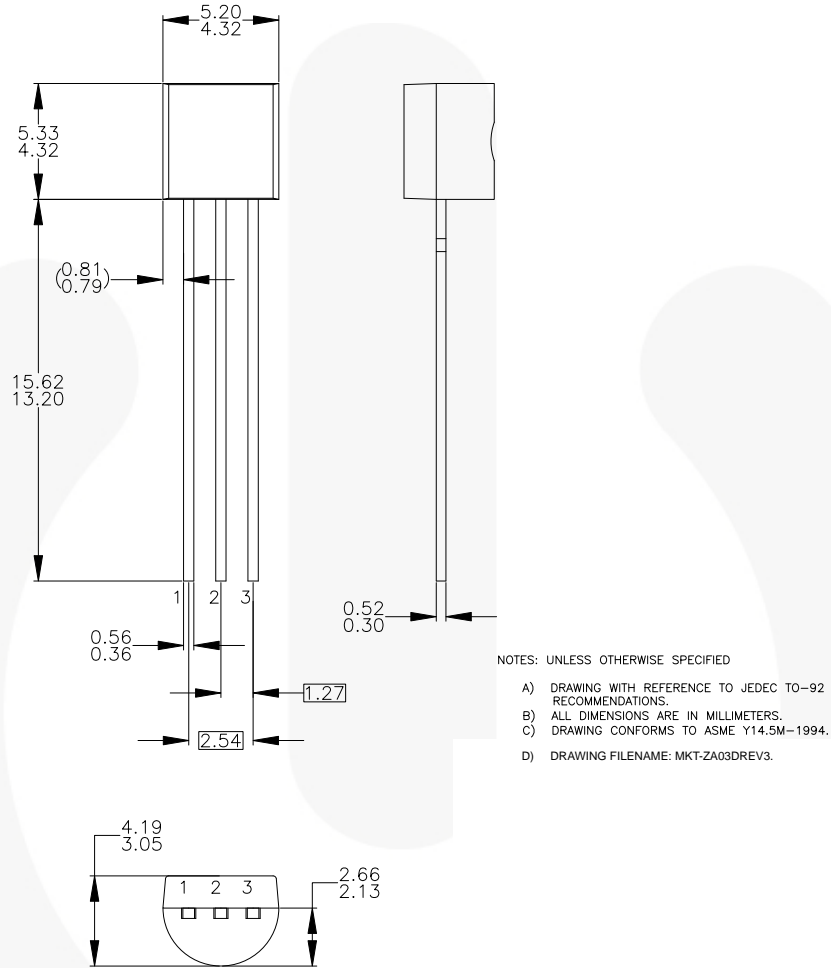

Figure 4. 3-Lead, TO-92, MOLDED STD STRAIGHT LEAD (NO EOL CODE)

Package drawings are provided as a service to customers considering Fairchild components. Drawings may change in any manner without notice. Please note the revision and/or date on the drawing and contact a Fairchild Semiconductor representative to verify or obtain the most recent revision. Package specifications do not expand the terms of Fairchild's worldwide terms and conditions, specifically the warranty therein, which covers Fairchild products.

Always visit Fairchild Semiconductor's online packaging area for the most recent package drawings:  
<http://www.fairchildsemi.com/packaging/>.

For current tape and reel specifications, visit Fairchild Semiconductor's online packaging area:  
[http://www.fairchildsemi.com/packaging/tr/to92pdd\\_tr.pdf](http://www.fairchildsemi.com/packaging/tr/to92pdd_tr.pdf).

Physical Dimensions (Continued)

TO-92 Formed Lead For T&R and Ammo Packing

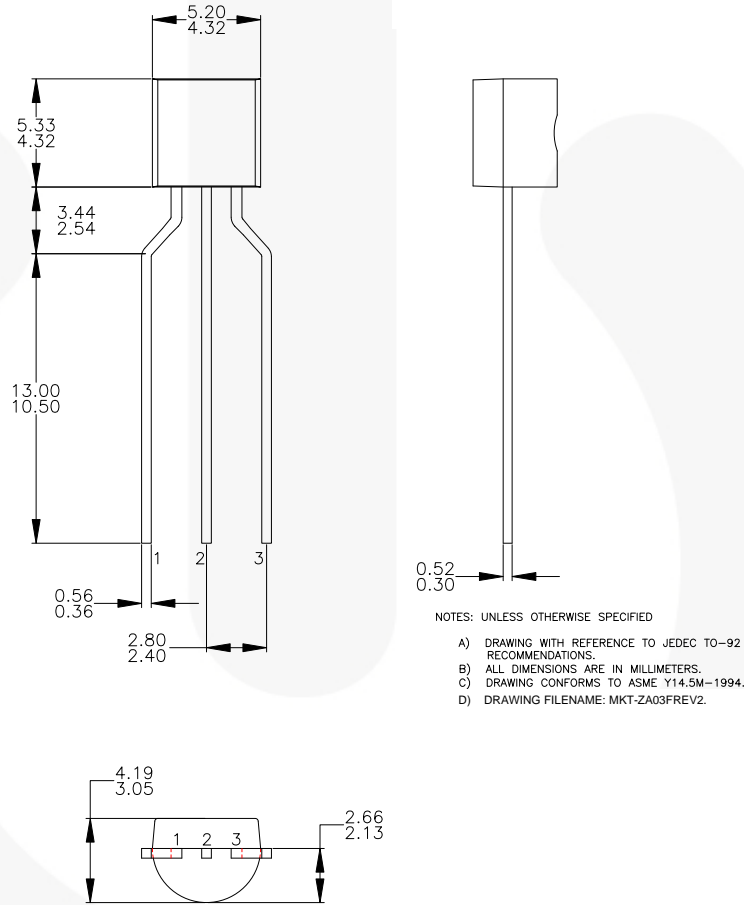

Figure 5. 3-Lead, TO-92, MOLDED 0.200 IN LINE SPACING LD FORM (J61Z OPTION)

Package drawings are provided as a service to customers considering Fairchild components. Drawings may change in any manner without notice. Please note the revision and/or date on the drawing and contact a Fairchild Semiconductor representative to verify or obtain the most recent revision. Package specifications do not expand the terms of Fairchild's worldwide terms and conditions, specifically the warranty therein, which covers Fairchild products.

Always visit Fairchild Semiconductor's online packaging area for the most recent package drawings:

<http://www.fairchildsemi.com/packaging/>

For current tape and reel specifications, visit Fairchild Semiconductor's online packaging area:

[http://www.fairchildsemi.com/packaging/tr/to92\\_tr.pdf](http://www.fairchildsemi.com/packaging/tr/to92_tr.pdf)

Physical Dimensions (Continued)

8-SOIC

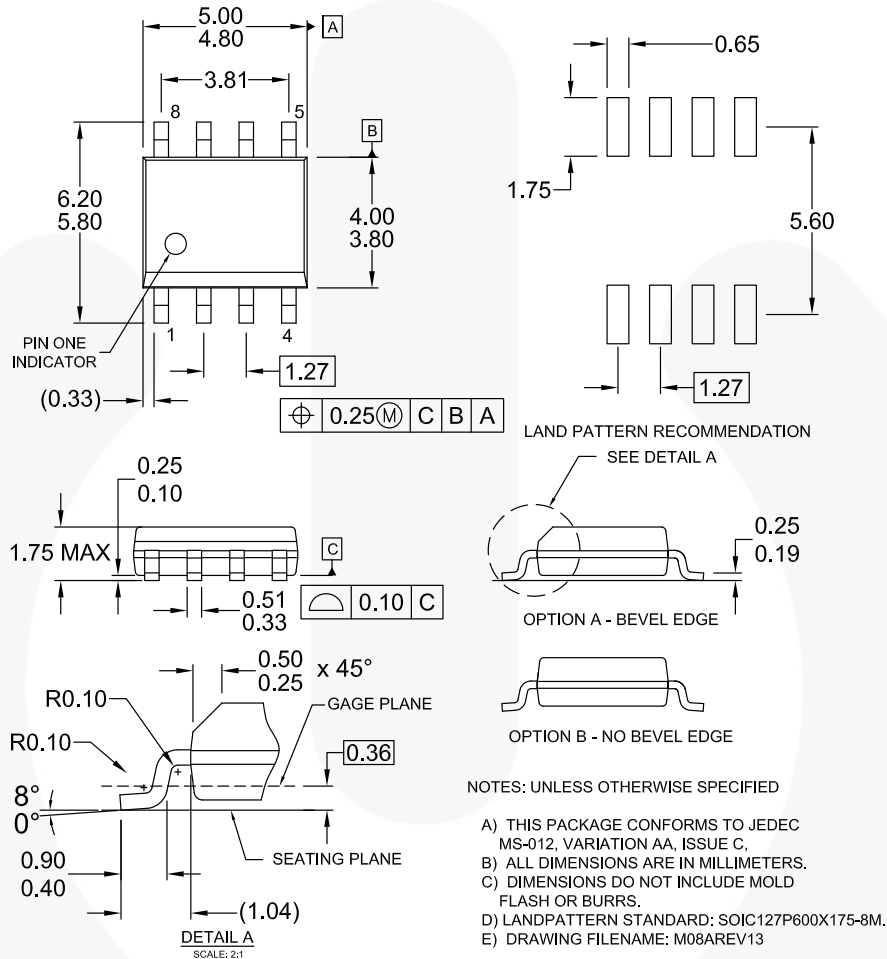

Figure 6. 8-Lead, SOIC, JEDEC MS-012, 0.150" NARROW BODY

Package drawings are provided as a service to customers considering Fairchild components. Drawings may change in any manner without notice. Please note the revision and/or date on the drawing and contact a Fairchild Semiconductor representative to verify or obtain the most recent revision. Package specifications do not expand the terms of Fairchild's worldwide terms and conditions, specifically the warranty therein, which covers Fairchild products.





Always visit Fairchild Semiconductor's online packaging area for the most recent package drawings:  
<http://www.fairchildsemi.com/packaging/>

For current tape and reel specifications, visit Fairchild Semiconductor's online packaging area:  
[http://www.fairchildsemi.com/packaging/tr/soic8\\_tr.pdf](http://www.fairchildsemi.com/packaging/tr/soic8_tr.pdf)



**TRADEMARKS**

The following includes registered and unregistered trademarks and service marks, owned by Fairchild Semiconductor and/or its global subsidiaries, and is not intended to be an exhaustive list of all such trademarks.

2Cool™	FPS™		Sync-Lock™
AccuPower™	F-PFS™	PowerTrench®	
AX-CAP®*	FRFET®	PowerXS™	TinyBoost™
BitSiC™	Global Power Resource <sup>SM</sup>	Programmable Active Droop™	TinyBuck™
Build it Now™	GreenBridge™	QFET®	TinyCalc™
CorePLUS™	Green FPS™	QS™	TinyLogic®
CorePOWER™	Green FPS™ e-Series™	Quiet Series™	TINYOPTO™
CROSSVOLT™	Gmax™	RapidConfigure™	TinyPower™
CTL™	GTO™		TinyPWM™
Current Transfer Logic™	IntelliMAX™	Saving our world, 1mW/W/kW at a time™	TinyWire™
DEUXPEED®	ISOPLANAR™	SignalWise™	TranSiC™
Dual Cool™	Making Small Speakers Sound Louder and Better™	SmartMax™	TriFault Detect™
EcoSPARK®	MegaBuck™	SMART START™	TRUECURRENT®*
EfficientMax™	MICROCOUPLER™	Solutions for Your Success™	μSerDes™
ESBC™	MicroFET™	SPM®	
	MicroPak™	STEALTH™	UHC®
Fairchild®	MicroPak2™	SuperFET®	Ultra FRFET™
Fairchild Semiconductor®	MillerDrive™	SuperSOT™-3	UniFET™
FACT Quiet Series™	MotionMax™	SuperSOT™-6	VXC™
FACT®	mWSaver™	SuperSOT™-8	VisualMax™
FAST®	OptoHi™	SupreMOS®	VoltagePlus™
FastvCore™	OPTOLOGIC®	SyncFET™	XS™
FETBench™	OPTOPLANAR®		

\* Trademarks of System General Corporation, used under license by Fairchild Semiconductor.

**DISCLAIMER**

FAIRCHILD SEMICONDUCTOR RESERVES THE RIGHT TO MAKE CHANGES WITHOUT FURTHER NOTICE TO ANY PRODUCTS HEREIN TO IMPROVE RELIABILITY, FUNCTION, OR DESIGN. FAIRCHILD DOES NOT ASSUME ANY LIABILITY ARISING OUT OF THE APPLICATION OR USE OF ANY PRODUCT OR CIRCUIT DESCRIBED HEREIN; NEITHER DOES IT CONVEY ANY LICENSE UNDER ITS PATENT RIGHTS, NOR THE RIGHTS OF OTHERS. THESE SPECIFICATIONS DO NOT EXPAND THE TERMS OF FAIRCHILD'S WORLDWIDE TERMS AND CONDITIONS, SPECIFICALLY THE WARRANTY THEREIN, WHICH COVERS THESE PRODUCTS.

**LIFE SUPPORT POLICY**

FAIRCHILD'S PRODUCTS ARE NOT AUTHORIZED FOR USE AS CRITICAL COMPONENTS IN LIFE SUPPORT DEVICES OR SYSTEMS WITHOUT THE EXPRESS WRITTEN APPROVAL OF FAIRCHILD SEMICONDUCTOR CORPORATION.

As used herein:

1. Life support devices or systems are devices or systems which, (a) are intended for surgical implant into the body or (b) support or sustain life, and (c) whose failure to perform when properly used in accordance with instructions for use provided in the labeling, can be reasonably expected to result in a significant injury of the user.
2. A critical component in any component of a life support, device, or system whose failure to perform can be reasonably expected to cause the failure of the life support device or system, or to affect its safety or effectiveness.

**ANTI-COUNTERFEITING POLICY**

Fairchild Semiconductor Corporation's Anti-Counterfeiting Policy. Fairchild's Anti-Counterfeiting Policy is also stated on our external website, [www.fairchildsemi.com](http://www.fairchildsemi.com), under Sales Support.

Counterfeiting of semiconductor parts is a growing problem in the industry. All manufacturers of semiconductor products are experiencing counterfeiting of their parts. Customers who inadvertently purchase counterfeit parts experience many problems such as loss of brand reputation, substandard performance, failed applications, and increased cost of production and manufacturing delays. Fairchild is taking strong measures to protect ourselves and our customers from the proliferation of counterfeit parts. Fairchild strongly encourages customers to purchase Fairchild parts either directly from Fairchild or from Authorized Fairchild Distributors who are listed by country on our web page cited above. Products customers buy either from Fairchild directly or from Authorized Fairchild Distributors are genuine parts, have full traceability, meet Fairchild's quality standards for handling and storage and provide access to Fairchild's full range of up-to-date technical and product information. Fairchild and our Authorized Distributors will stand behind all warranties and will appropriately address any warranty issues that may arise. Fairchild will not provide any warranty coverage or other assistance for parts bought from Unauthorized Sources. Fairchild is committed to combat this global problem and encourage our customers to do their part in stopping this practice by buying direct or from authorized distributors.

**PRODUCT STATUS DEFINITIONS**

**Definition of Terms**

Datasheet Identification	Product Status	Definition
Advance Information	Formative / In Design	Datasheet contains the design specifications for product development. Specifications may change in any manner without notice.
Preliminary	First Production	Datasheet contains preliminary data; supplementary data will be published at a later date. Fairchild Semiconductor reserves the right to make changes at any time without notice to improve design.
No Identification Needed	Full Production	Datasheet contains final specifications. Fairchild Semiconductor reserves the right to make changes at any time without notice to improve the design.
Obsolete	Not In Production	Datasheet contains specifications on a product that is discontinued by Fairchild Semiconductor. The datasheet is for reference information only.