

LMP7701,LMP7702,LMP7704

*LMP7701/LMP7702/LMP7704 Precision, CMOS Input, RRIO, Wide Supply Range
Amplifiers*

Datasheet.Company



Literature Number: SNOSAI9G

LMP7701/LMP7702/LMP7704

Precision, CMOS Input, RRIO, Wide Supply Range Amplifiers

General Description

The LMP7701/LMP7702/LMP7704 are single, dual, and quad low offset voltage, rail-to-rail input and output precision amplifiers each with a CMOS input stage and a wide supply voltage range. The LMP7701/LMP7702/LMP7704 are part of the LMP® precision amplifier family and are ideal for sensor interface and other instrumentation applications.

The guaranteed low offset voltage of less than $\pm 200 \mu\text{V}$ along with the guaranteed low input bias current of less than $\pm 1 \text{ pA}$ make the LMP7701 ideal for precision applications. The LMP7701/LMP7702/LMP7704 are built utilizing VIP50 technology, which allows the combination of a CMOS input stage and a 12V common mode and supply voltage range. This makes the LMP7701/LMP7702/LMP7704 great choices in many applications where conventional CMOS parts cannot operate under the desired voltage conditions.

The LMP7701/LMP7702/LMP7704 each have a rail-to-rail input stage that significantly reduces the CMRR glitch commonly associated with rail-to-rail input amplifiers. This is achieved by trimming both sides of the complimentary input stage, thereby reducing the difference between the NMOS and PMOS offsets. The output of the LMP7701/LMP7702/LMP7704 swings within 40 mV of either rail to maximize the signal dynamic range in applications requiring low supply voltage.

The LMP7701 is offered in the space saving 5-Pin SOT23 and 8-Pin SOIC package. The LMP7702 is offered in the 8-Pin SOIC and 8-Pin MSOP package. The quad LMP7704 is offered in the 14-Pin SOIC and 14-Pin TSSOP package. These small packages are ideal solutions for area constrained PC boards and portable electronics.

Features

Unless otherwise noted, typical values at $V_S = 5\text{V}$

- Input offset voltage (LMP7701) $\pm 200 \mu\text{V}$ (max)
- Input offset voltage (LMP7702/LMP7704) $\pm 220 \mu\text{V}$ (max)
- Input bias current $\pm 200 \text{ fA}$
- Input voltage noise $9 \text{ nV}/\sqrt{\text{Hz}}$
- CMRR 130 dB
- Open loop gain 130 dB
- Temperature range -40°C to 125°C
- Unity gain bandwidth 2.5 MHz
- Supply current (LMP7701) 715 μA
- Supply current (LMP7702) 1.5 mA
- Supply current (LMP7704) 2.9 mA
- Supply voltage range 2.7V to 12V
- Rail-to-rail input and output

Applications

- High impedance sensor interface
- Battery powered instrumentation
- High gain amplifiers
- DAC buffer
- Instrumentation amplifier
- Active filters

Typical Application

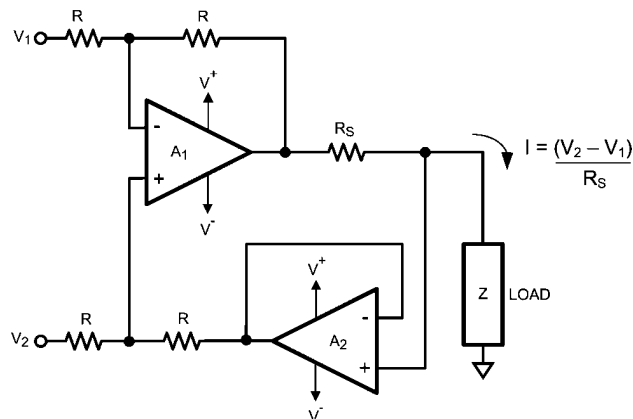

Precision Current Source

20127305

Absolute Maximum Ratings (Note 1)

If Military/Aerospace specified devices are required, please contact the National Semiconductor Sales Office/ Distributors for availability and specifications.

ESD Tolerance (Note 2)

Human Body Model	2000V
Machine Model	200V
Charge-Device Model	1000V
V_{IN} Differential	± 300 mV
Supply Voltage ($V_S = V^+ - V^-$)	13.2V
Voltage at Input/Output Pins	$V^{++} 0.3V, V^- - 0.3V$
Input Current	10 mA
Storage Temperature Range	-65°C to $+150^\circ\text{C}$
Junction Temperature (Note 3)	$+150^\circ\text{C}$

Soldering Information

Infrared or Convection (20 sec)	235°C
Wave Soldering Lead Temp. (10 sec)	260°C

Operating Ratings (Note 1)

Temperature Range (Note 3)	-40°C to $+125^\circ\text{C}$
Supply Voltage ($V_S = V^+ - V^-$)	2.7V to 12V
Package Thermal Resistance (θ_{JA} (Note 3))	
5-Pin SOT23	265°C/W
8-Pin SOIC	190°C/W
8-Pin MSOP	235°C/W
14-Pin SOIC	145°C/W
14-Pin TSSOP	122°C/W

3V Electrical Characteristics (Note 4)

Unless otherwise specified, all limits are guaranteed for $T_A = 25^\circ\text{C}$, $V^+ = 3V$, $V^- = 0V$, $V_{CM} = V^+/2$, and $R_L > 10\text{ k}\Omega$ to $V^+/2$.

Boldface limits apply at the temperature extremes.

Symbol	Parameter	Conditions	Min (Note 6)	Typ (Note 5)	Max (Note 6)	Units
V_{OS}	Input Offset Voltage	LMP7701		± 37	± 200 ± 500	μV
		LMP7702/LMP7704		± 56	± 220 ± 520	
TCV_{OS}	Input Offset Voltage Temperature Drift	(Note 7)		± 1	± 5	$\mu\text{V}/^\circ\text{C}$
I_B	Input Bias Current	(Notes 7, 8) $-40^\circ\text{C} \leq T_A \leq 85^\circ\text{C}$		± 0.2	± 1 ± 50	pA
		(Notes 7, 8) $-40^\circ\text{C} \leq T_A \leq 125^\circ\text{C}$		± 0.2	± 1 ± 400	
I_{OS}	Input Offset Current			40		fA
CMRR	Common Mode Rejection Ratio	$0V \leq V_{CM} \leq 3V$ LMP7701	86 80	130		dB
		$0V \leq V_{CM} \leq 3V$ LMP7702/LMP7704	84 78	130		
PSRR	Power Supply Rejection Ratio	$2.7V \leq V^+ \leq 12V, V_O = V^+/2$	86 82	98		dB
CMVR	Common Mode Voltage Range	CMRR ≥ 80 dB CMRR ≥ 77 dB	-0.2 -0.2		3.2 3.2	V
A_{VOL}	Open Loop Voltage Gain	$R_L = 2\text{ k}\Omega$ (LMP7701) $V_O = 0.3V$ to $2.7V$	100 96	114		dB
		$R_L = 2\text{ k}\Omega$ (LMP7702/LMP7704) $V_O = 0.3V$ to $2.7V$	100 94	114		
		$R_L = 10\text{ k}\Omega$ $V_O = 0.2V$ to $2.8V$	100 96	124		

Symbol	Parameter	Conditions	Min (Note 6)	Typ (Note 5)	Max (Note 6)	Units
V_{OUT}	Output Voltage Swing High	$R_L = 2\text{ k}\Omega$ to $V^+/2$ LMP7701		40	80 120	mV from V^+
		$R_L = 2\text{ k}\Omega$ to $V^+/2$ LMP7702/LMP7704		40	80 150	
		$R_L = 10\text{ k}\Omega$ to $V^+/2$ LMP7701		30	40 60	
		$R_L = 10\text{ k}\Omega$ to $V^+/2$ LMP7702/LMP7704		35	50 100	
	Output Voltage Swing Low	$R_L = 2\text{ k}\Omega$ to $V^+/2$ LMP7701		40	60 80	mV
		$R_L = 2\text{ k}\Omega$ to $V^+/2$ LMP7702/LMP7704		45	100 170	
		$R_L = 10\text{ k}\Omega$ to $V^+/2$ LMP7701		20	40 50	
		$R_L = 10\text{ k}\Omega$ to $V^+/2$ LMP7702/LMP7704		20	50 90	
I_{OUT}	Output Current (Notes 3, 9)	Sourcing $V_O = V^+/2$ $V_{IN} = 100\text{ mV}$	25 15	42		mA
		Sinking $V_O = V^+/2$ $V_{IN} = -100\text{ mV}$ (LMP7701)	25 20	42		
		Sinking $V_O = V^+/2$ $V_{IN} = -100\text{ mV}$ (LMP7702/ LMP7704)	25 15	42		
I_S	Supply Current	LMP7701		0.670	1.0 1.2	mA
		LMP7702		1.4	1.8 2.1	
		LMP7704		2.9	3.5 4.5	
SR	Slew Rate (Note 10)	$A_V = +1$, $V_O = 2\text{ V}_{PP}$ 10% to 90%		0.9		V/ μ s
GBW	Gain Bandwidth			2.5		MHz
THD+N	Total Harmonic Distortion + Noise	$f = 1\text{ kHz}$, $A_V = 1$, $R_L = 10\text{ k}\Omega$		0.02		%
e_n	Input Referred Voltage Noise Density	$f = 1\text{ kHz}$		9		$\text{nV}/\sqrt{\text{Hz}}$
i_n	Input Referred Current Noise Density	$f = 100\text{ kHz}$		1		$\text{fA}/\sqrt{\text{Hz}}$

5V Electrical Characteristics (Note 4)

Unless otherwise specified, all limits are guaranteed for $T_A = 25^\circ\text{C}$, $V^+ = 5\text{V}$, $V^- = 0\text{V}$, $V_{CM} = V^+/2$, and $R_L > 10\text{ k}\Omega$ to $V^+/2$.

Boldface limits apply at the temperature extremes.

Symbol	Parameter	Conditions	Min (Note 6)	Typ (Note 5)	Max (Note 6)	Units
V_{OS}	Input Offset Voltage	LMP7701		± 37	± 200 ± 500	μV
		LMP7702/LMP7704		± 32	± 220 ± 520	
TCV_{OS}	Input Offset Voltage Temperature Drift	(Note 7)		± 1	± 5	$\mu\text{V}/^\circ\text{C}$
I_B	Input Bias Current	(Notes 7, 8) $-40^\circ\text{C} \leq T_A \leq 85^\circ\text{C}$		± 0.2	± 1 ± 50	pA
		(Notes 7, 8) $-40^\circ\text{C} \leq T_A \leq 125^\circ\text{C}$		± 0.2	± 1 ± 400	

Symbol	Parameter	Conditions	Min (Note 6)	Typ (Note 5)	Max (Note 6)	Units	
I_{OS}	Input Offset Current			40		fA	
CMRR	Common Mode Rejection Ratio	$0V \leq V_{CM} \leq 5V$ LMP7701	88 83	130		dB	
		$0V \leq V_{CM} \leq 5V$ LMP7702/LMP7704	86 81	130			
PSRR	Power Supply Rejection Ratio	$2.7V \leq V^+ \leq 12V, V_O = V^+/2$	86 82	100		dB	
CMVR	Common Mode Voltage Range	CMRR ≥ 80 dB CMRR ≥ 78 dB	-0.2 -0.2		5.2 5.2	V	
A_{VOL}	Open Loop Voltage Gain	$R_L = 2$ k Ω (LMP7701) $V_O = 0.3V$ to $4.7V$	100 96	119		dB	
		$R_L = 2$ k Ω (LMP7702/LMP7704) $V_O = 0.3V$ to $4.7V$	100 94	119			
		$R_L = 10$ k Ω $V_O = 0.2V$ to $4.8V$	100 96	130			
V_{OUT}	Output Voltage Swing High	$R_L = 2$ k Ω to $V^+/2$ LMP7701		60	110 130	mV from V^+	
		$R_L = 2$ k Ω to $V^+/2$ LMP7702/LMP7704		60	120 200		
		$R_L = 10$ k Ω to $V^+/2$ LMP7701		40	50 70		
		$R_L = 10$ k Ω to $V^+/2$ LMP7702/LMP7704		40	60 120		
	Output Voltage Swing Low	$R_L = 2$ k Ω to $V^+/2$ LMP7701			50	80 90	mV
		$R_L = 2$ k Ω to $V^+/2$ LMP7702/LMP7704			50	120 190	
		$R_L = 10$ k Ω to $V^+/2$ LMP7701			30	40 50	
		$R_L = 10$ k Ω to $V^+/2$ LMP7702/LMP7704			30	50 100	
I_{OUT}	Output Current (Notes 3, 9)	Sourcing $V_O = V^+/2$ $V_{IN} = 100$ mV (LMP7701)	40 28	66		mA	
		Sourcing $V_O = V^+/2$ $V_{IN} = 100$ mV (LMP7702/LMP7704)	38 25	66			
		Sinking $V_O = V^+/2$ $V_{IN} = -100$ mV (LMP7701)	40 28	76			
		Sinking $V_O = V^+/2$ $V_{IN} = -100$ mV (LMP7702/LMP7704)	40 23	76			
I_S	Supply Current	LMP7701		0.715	1.0 1.2	mA	
		LMP7702		1.5	1.9 2.2		
		LMP7704		2.9	3.7 4.6		
SR	Slew Rate (Note 10)	$A_V = +1, V_O = 4 V_{PP}$ 10% to 90%		1.0		V/ μ s	
GBW	Gain Bandwidth			2.5		MHz	
THD+N	Total Harmonic Distortion + Noise	$f = 1$ kHz, $A_V = 1, R_L = 10$ k Ω		0.02		%	

Symbol	Parameter	Conditions	Min (Note 6)	Typ (Note 5)	Max (Note 6)	Units
e_n	Input Referred Voltage Noise Density	$f = 1 \text{ kHz}$		9		$\text{nV}/\sqrt{\text{Hz}}$
i_n	Input Referred Current Noise Density	$f = 100 \text{ kHz}$		1		$\text{fA}/\sqrt{\text{Hz}}$

±5V Electrical Characteristics (Note 4)

Unless otherwise specified, all limits are guaranteed for $T_A = 25^\circ\text{C}$, $V^+ = 5\text{V}$, $V^- = -5\text{V}$, $V_{\text{CM}} = 0\text{V}$, and $R_L > 10 \text{ k}\Omega$ to 0V . **Bold-face** limits apply at the temperature extremes.

Symbol	Parameter	Conditions	Min (Note 6)	Typ (Note 5)	Max (Note 6)	Units
V_{OS}	Input Offset Voltage	LMP7701		± 37	± 200 ± 500	μV
		LMP7702/LMP7704		± 37	± 220 ± 520	
TCV_{OS}	Input Offset Voltage Temperature Drift	(Note 7)		± 1	± 5	$\mu\text{V}/^\circ\text{C}$
I_B	Input Bias Current	(Notes 7, 8) $-40^\circ\text{C} \leq T_A \leq 85^\circ\text{C}$		± 0.2	1 ± 50	pA
		(Notes 7, 8) $-40^\circ\text{C} \leq T_A \leq 125^\circ\text{C}$		± 0.2	1 ± 400	
I_{OS}	Input Offset Current			40		fA
CMRR	Common Mode Rejection Ratio	$-5\text{V} \leq V_{\text{CM}} \leq 5\text{V}$ LMP7701	92 88	138		dB
		$-5\text{V} \leq V_{\text{CM}} \leq 5\text{V}$ LMP7702/LMP7704	90 86	138		
PSRR	Power Supply Rejection Ratio	$2.7\text{V} \leq V^+ \leq 12\text{V}$, $V_O = 0\text{V}$	86 82	98		dB
CMVR	Common Mode Voltage Range	CMRR $\geq 80 \text{ dB}$ CMRR $\geq 78 \text{ dB}$	-5.2 -5.2		5.2 5.2	V
A_{VOL}	Open Loop Voltage Gain	$R_L = 2 \text{ k}\Omega$ (LMP7701) $V_O = -4.7\text{V}$ to 4.7V	100 98	121		dB
		$R_L = 2 \text{ k}\Omega$ (LMP7702/LMP7704) $V_O = -4.7\text{V}$ to 4.7V	100 94	121		
		$R_L = 10 \text{ k}\Omega$ (LMP7701) $V_O = -4.8\text{V}$ to 4.8V	100 98	134		
		$R_L = 10 \text{ k}\Omega$ (LMP7702/LMP7704) $V_O = -4.8\text{V}$ to 4.8V	100 97	134		

Symbol	Parameter	Conditions	Min (Note 6)	Typ (Note 5)	Max (Note 6)	Units
V _{OUT}	Output Voltage Swing High	R _L = 2 kΩ to 0V LMP7701		90	150 170	mV from V ⁺
		R _L = 2 kΩ to 0V LMP7702/LMP7704		90	180 290	
		R _L = 10 kΩ to 0V LMP7701		40	80 100	
		R _L = 10 kΩ to 0V LMP7702/LMP7704		40	80 150	
	Output Voltage Swing Low	R _L = 2 kΩ to 0V LMP7701		90	130 150	mV from V ⁻
		R _L = 2 kΩ to 0V LMP7702/LMP7704		90	180 290	
		R _L = 10 kΩ to 0V LMP7701		40	50 60	
		R _L = 10 kΩ to 0V LMP7702/LMP7704		40	60 110	
I _{OUT}	Output Current (Notes 3, 9)	Sourcing V _O = 0V V _{IN} = 100 mV (LMP7701)	50 35	86		mA
		Sourcing V _O = 0V V _{IN} = 100 mV (LMP7702/LMP7704)	48 33	86		
		Sinking V _O = 0V V _{IN} = -100 mV	50 35	84		
I _S	Supply Current	LMP7701		0.790	1.1 1.3	mA
		LMP7702		1.7	2.1 2.5	
		LMP7704		3.2	4.2 5.0	
SR	Slew Rate (Note 10)	A _V = +1, V _O = 9 V _{PP} 10% to 90%		1.1		V/μs
GBW	Gain Bandwidth			2.5		MHz
THD+N	Total Harmonic Distortion + Noise	f = 1 kHz, A _V = 1, R _L = 10 kΩ		0.02		%
e _n	Input Referred Voltage Noise Density	f = 1 kHz		9		nV/√Hz
i _n	Input Referred Current Noise Density	f = 100 kHz		1		fA/√Hz

Note 1: Absolute Maximum Ratings indicate limits beyond which damage to the device may occur. Operating Ratings indicate conditions for which the device is intended to be functional, but specific performance is not guaranteed. For guaranteed specifications and the test conditions, see the Electrical Characteristics Tables.

Note 2: Human Body Model, applicable std. MIL-STD-883, Method 3015.7. Machine Model, applicable std. JESD22-A115-A (ESD MM std. of JEDEC) Field-Induced Charge-Device Model, applicable std. JESD22-C101-C (ESD FICDM std. of JEDEC).

Note 3: The maximum power dissipation is a function of T_{J(MAX)}, θ_{JA}. The maximum allowable power dissipation at any ambient temperature is P_D = (T_{J(MAX)} - T_A) / θ_{JA}. All numbers apply for packages soldered directly onto a PC Board.

Note 4: Electrical Table values apply only for factory testing conditions at the temperature indicated. Factory testing conditions result in very limited self-heating of the device such that T_J = T_A. No guarantee of parametric performance is indicated in the electrical tables under conditions of internal self-heating where T_J > T_A.

Note 5: Typical values represent the most likely parametric norm as determined at the time of characterization. Actual typical values may vary over time and will also depend on the application and configuration. The typical values are not tested and are not guaranteed on shipped production material.

Note 6: Limits are 100% production tested at 25°C. Limits over the operating temperature range are guaranteed through correlations using the Statistical Quality Control (SQC) method.

Note 7: This parameter is guaranteed by design and/or characterization and is not tested in production.

Note 8: Positive current corresponds to current flowing into the device.

Note 9: The short circuit test is a momentary test.

Note 10: The number specified is the slower of positive and negative slew rates.

Connection Diagrams

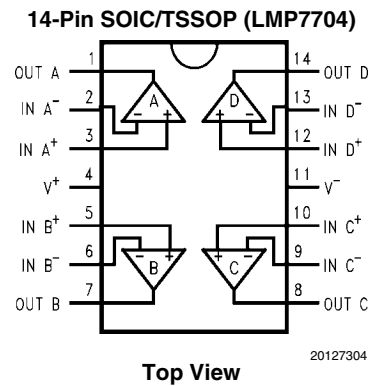
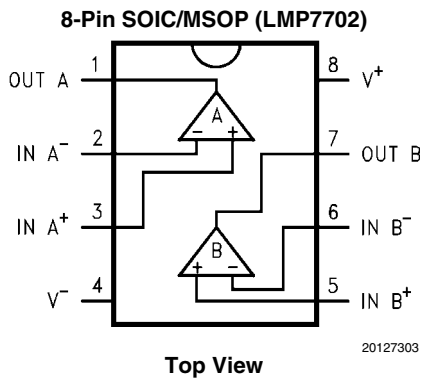
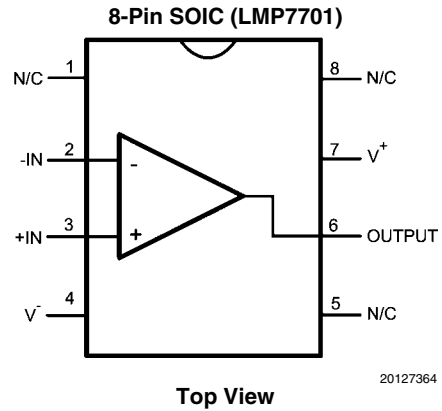
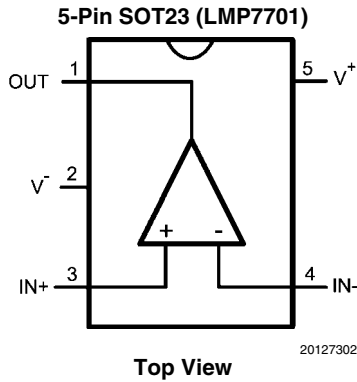

Ordering Information

Package	Part Number	Package Marking	Transport Media	NSC Drawing
5-Pin SOT23	LMP7701MF	AC2A	1k Units Tape and Reel	MF05A
	LMP7701MFX		3k Units Tape and Reel	
8-Pin SOIC	LMP7701MA	LMP7701MA	95 Units/Rail	M08A
	LMP7701MAX		2.5k Units Tape and Reel	
8-Pin SOIC	LMP7702MA	LMP7702MA	95 Units/Rail	M08A
	LMP7702MAX		2.5k Units Tape and Reel	
8-Pin MSOP	LMP7702MM	AA3A	1k Units Tape and Reel	MUA08A
	LMP7702MMX		3.5k Units Tape and Reel	
14-Pin SOIC	LMP7704MA	LMP7704MA	55 Units/Rail	M14A
	LMP7704MAX		2.5k Units Tape and Reel	
14-Pin TSSOP	LMP7704MT	LMP7704MT	94 Units/Rail	MTC14
	LMP7704MTX		2.5k Units Tape and Reel	

Typical Performance Characteristics Unless otherwise noted: $T_A = 25^\circ\text{C}$, $V_{\text{CM}} = V_S/2$, $R_L > 10\text{ k}\Omega$.

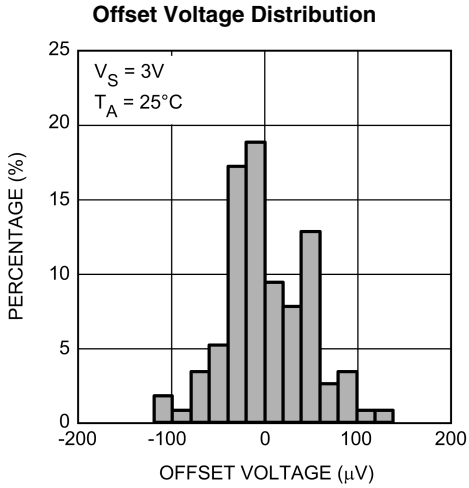

20127336

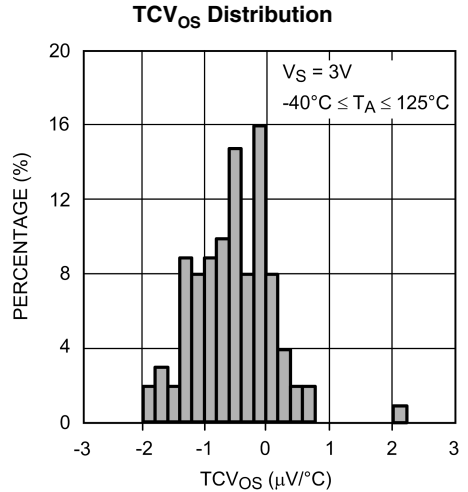

20127341

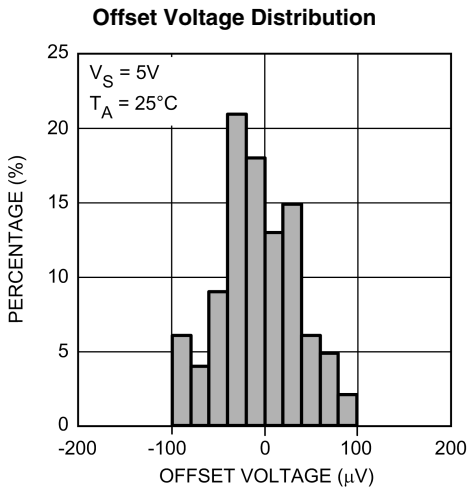

20127337

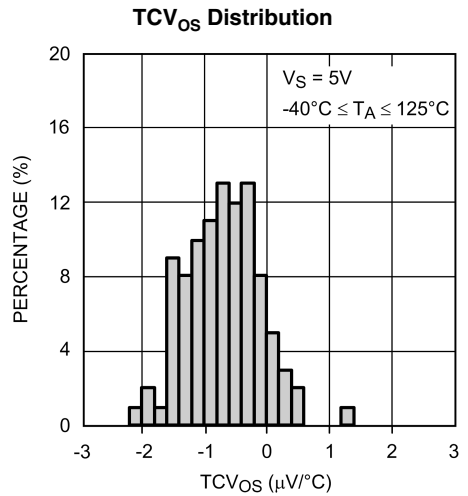

20127342

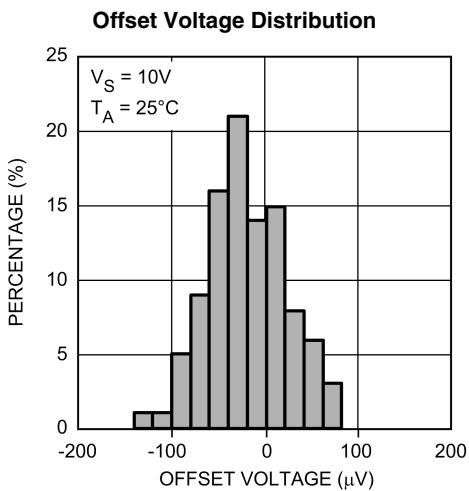

20127338

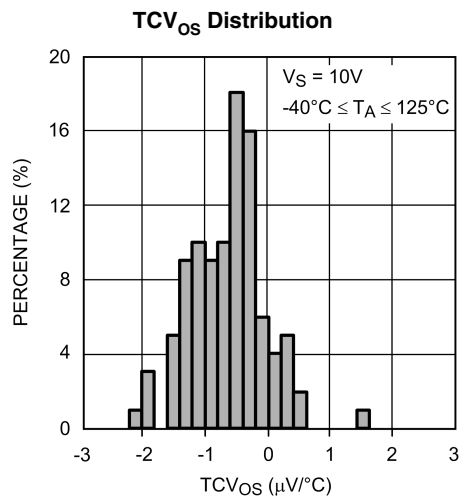

20127343

Offset Voltage vs. Temperature

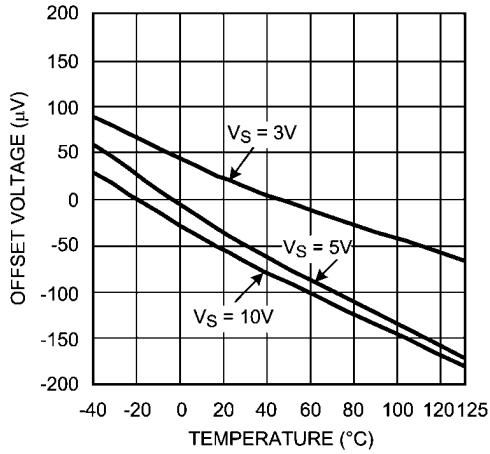

20127306

CMRR vs. Frequency

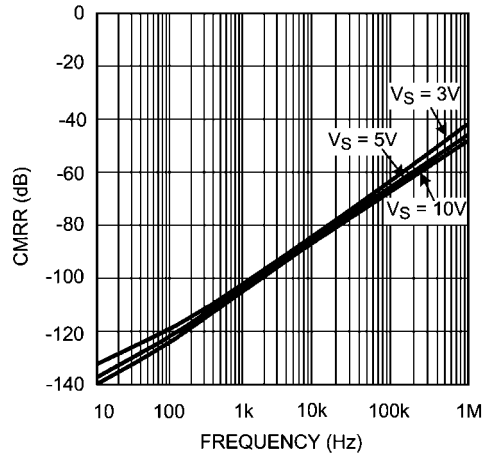

20127350

Offset Voltage vs. Supply Voltage

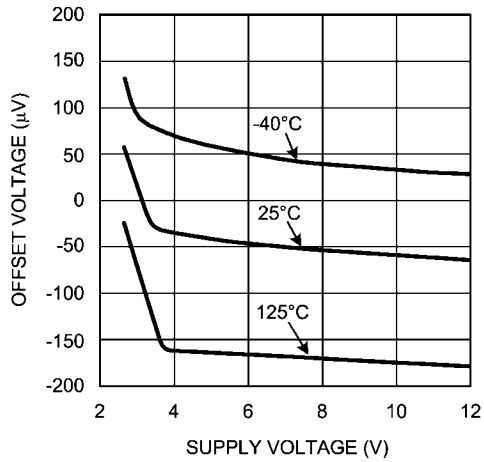

20127310

Offset Voltage vs. V_{CM}

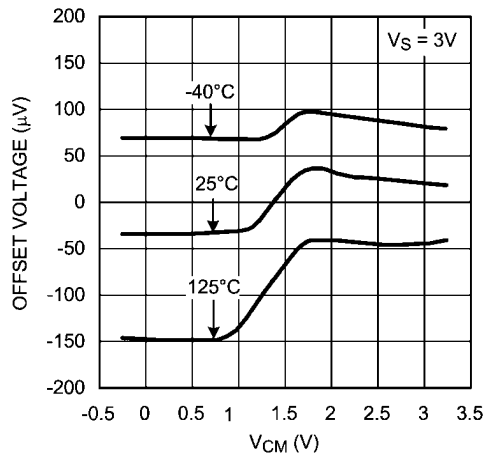

20127307

Offset Voltage vs. V_{CM}

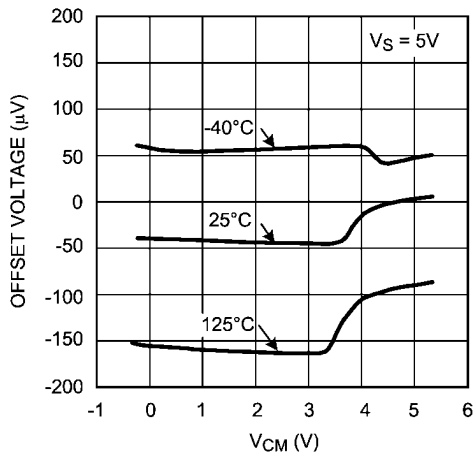

20127308

Offset Voltage vs. V_{CM}

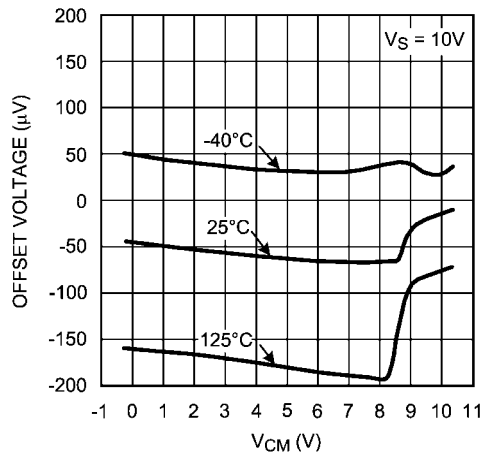

20127309

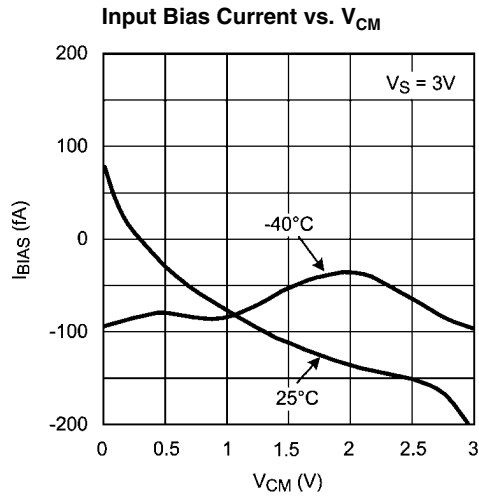

20127346

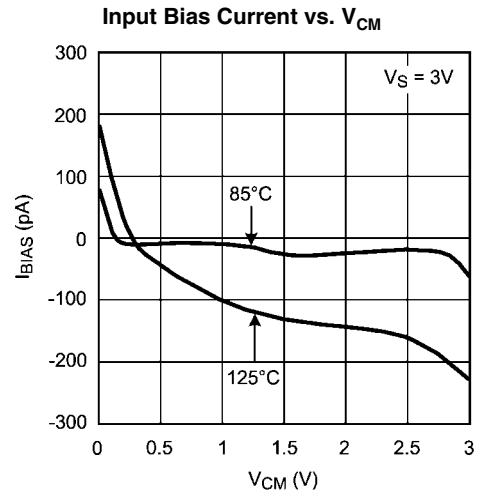

20127330

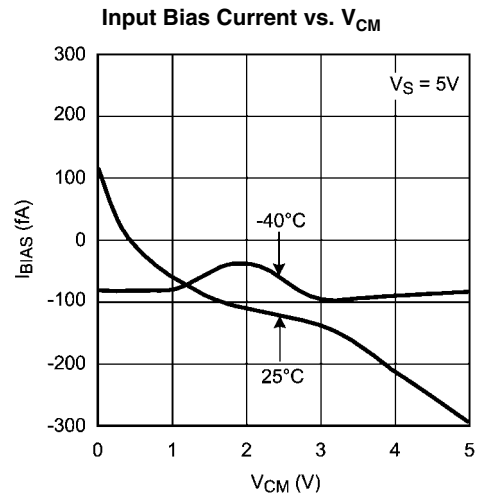

20127347

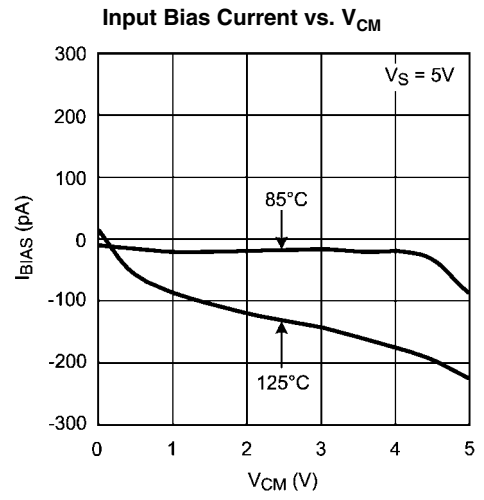

20127331

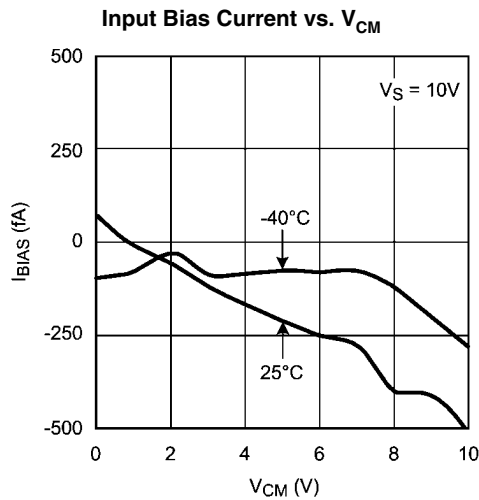

20127348

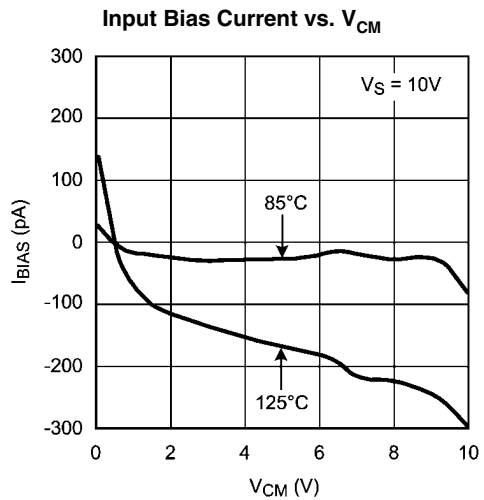

20127349

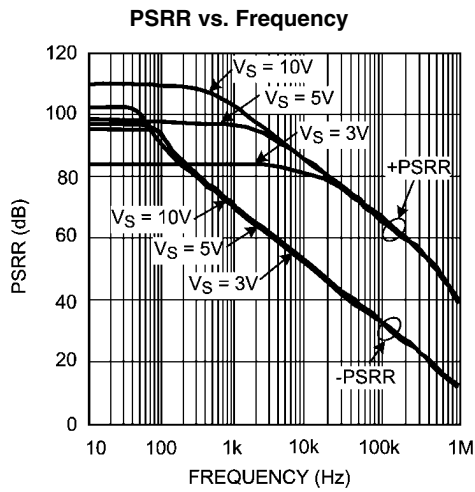

20127345

Supply Current vs. Supply Voltage (Per Channel)

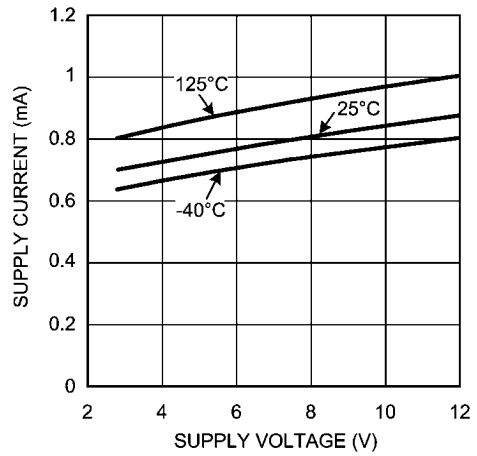

20127311

Sinking Current vs. Supply Voltage

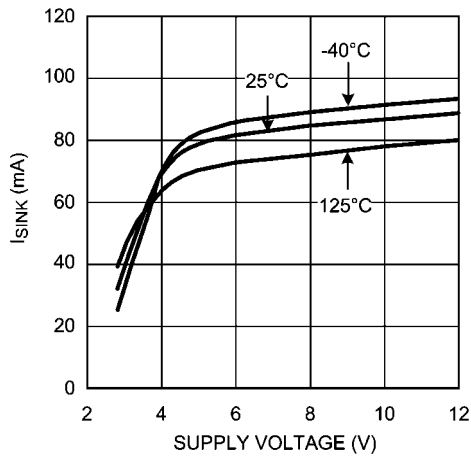

20127313

Sourcing Current vs. Supply Voltage

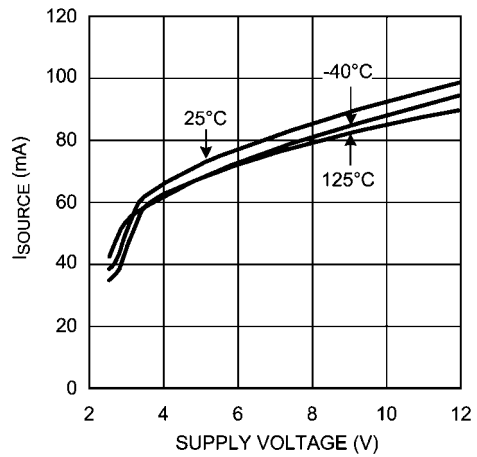

20127312

Output Voltage vs. Output Current

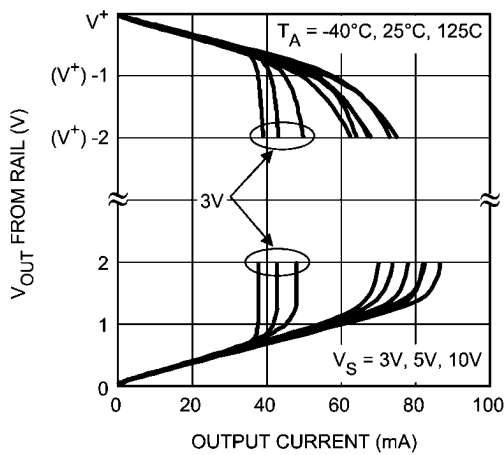

20127316

Slew Rate vs. Supply Voltage

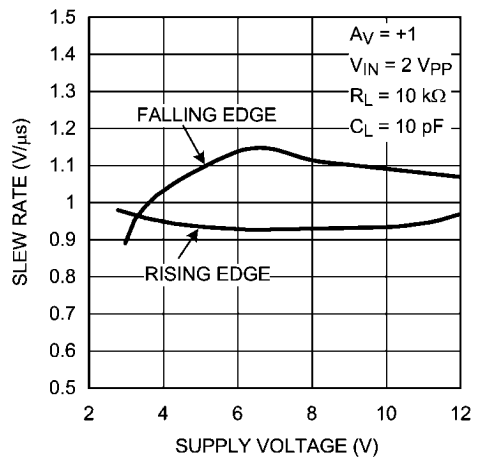

20127317

Open Loop Frequency Response

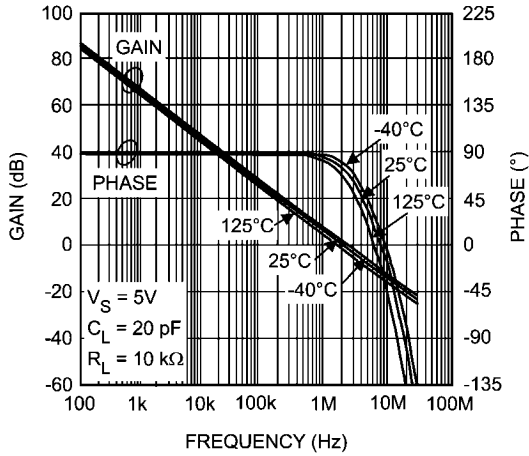

20127315

Open Loop Frequency Response

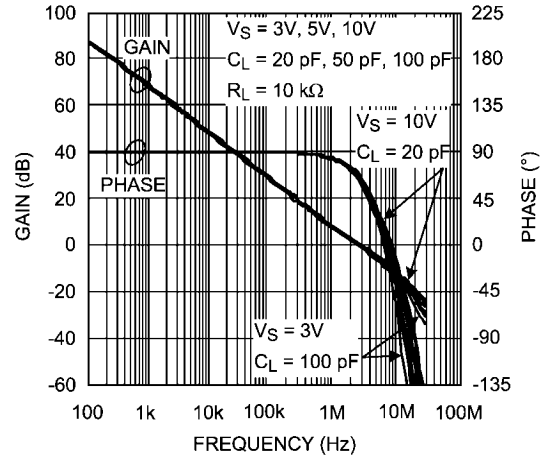

20127314

Large Signal Step Response

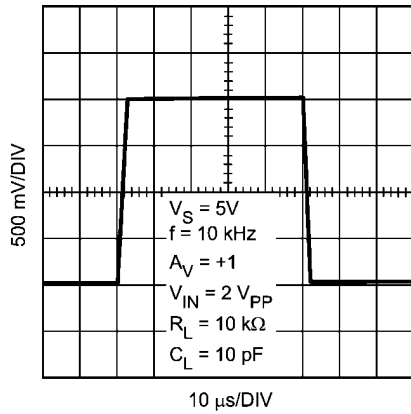

20127318

Small Signal Step Response

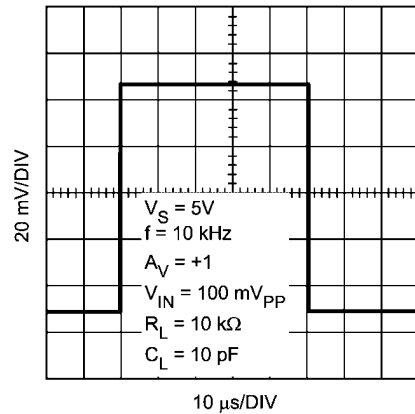

20127320

Large Signal Step Response

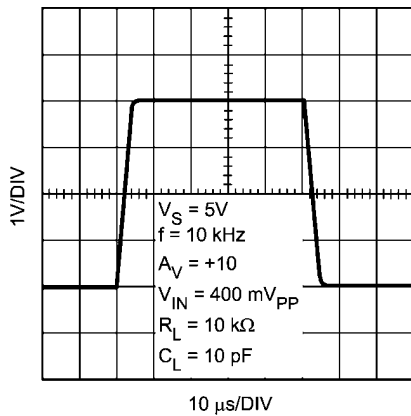

20127319

Small Signal Step Response

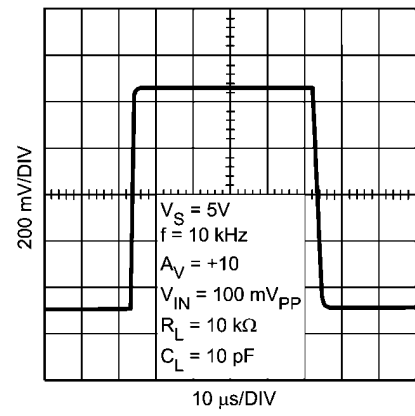

20127326

Input Voltage Noise vs. Frequency

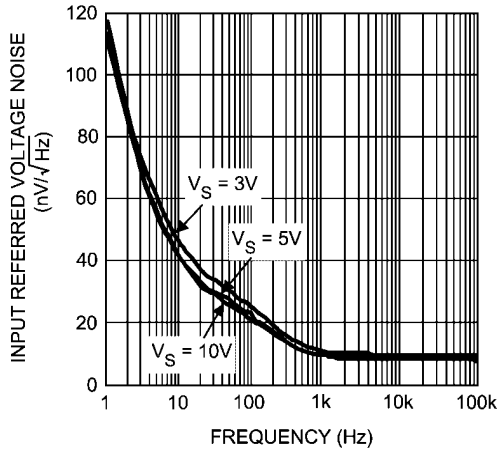

20127327

Open Loop Gain vs. Output Voltage Swing

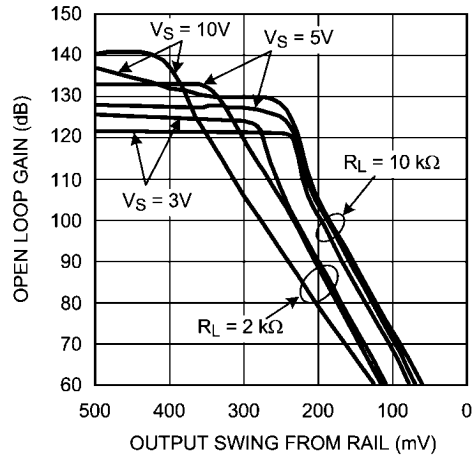

20127352

Output Swing High vs. Supply Voltage

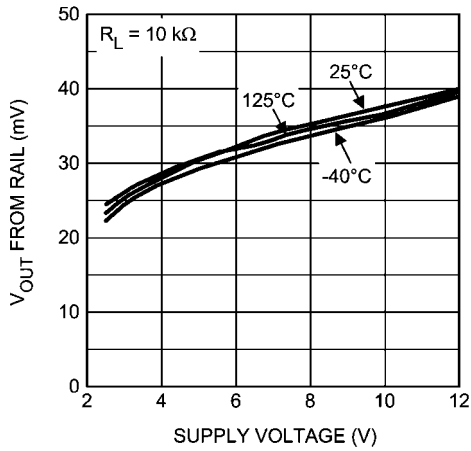

20127333

Output Swing Low vs. Supply Voltage

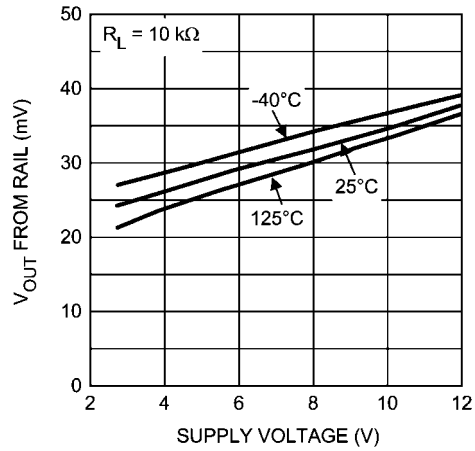

20127335

Output Swing High vs. Supply Voltage

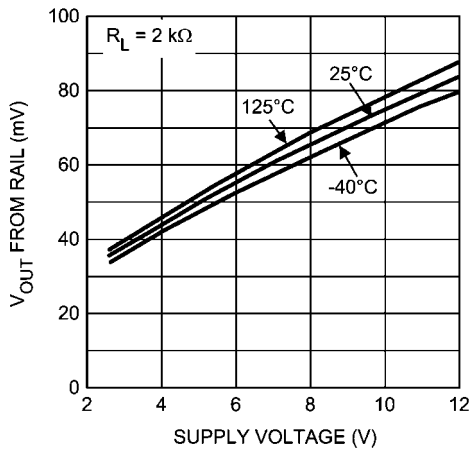

20127332

Output Swing Low vs. Supply Voltage

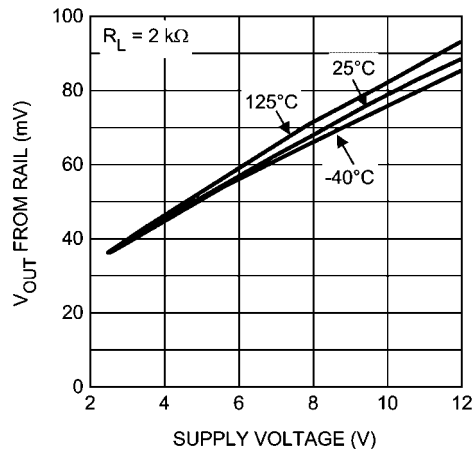

20127334

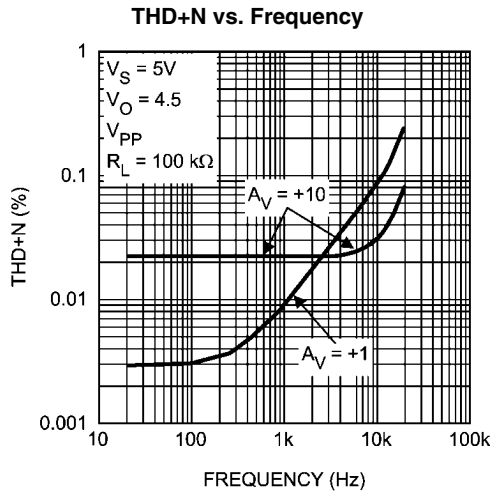

20127328

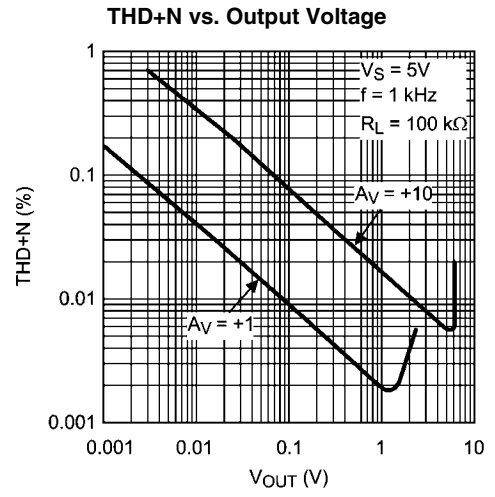

20127329

Crosstalk Rejection Ratio vs. Frequency (LMP7702/LMP7704)

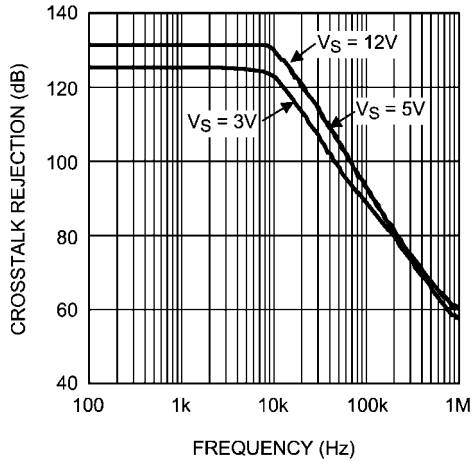

20127353

Application Information

LMP7701/LMP7702/LMP7704

The LMP7701/LMP7702/LMP7704 are single, dual, and quad low offset voltage, rail-to-rail input and output precision amplifiers each with a CMOS input stage and wide supply voltage range of 2.7V to 12V. The LMP7701/LMP7702/LMP7704 have a very low input bias current of only ± 200 fA at room temperature.

The wide supply voltage range of 2.7V to 12V over the extensive temperature range of -40°C to 125°C makes the LMP7701/LMP7702/LMP7704 excellent choices for low voltage precision applications with extensive temperature requirements.

The LMP7701/LMP7702/LMP7704 have only ± 37 μV of typical input referred offset voltage and this offset is guaranteed to be less than ± 500 μV for the single and ± 520 μV for the dual and quad, over temperature. This minimal offset voltage allows more accurate signal detection and amplification in precision applications.

The low input bias current of only ± 200 fA along with the low input referred voltage noise of $9 \text{ nV}/\sqrt{\text{Hz}}$ gives the LMP7701/LMP7702/LMP7704 superiority for use in sensor applications. Lower levels of noise from the LMP7701/LMP7702/LMP7704 mean of better signal fidelity and a higher signal-to-noise ratio.

National Semiconductor is heavily committed to precision amplifiers and the market segment they serve. Technical support and extensive characterization data is available for sensitive applications or applications with a constrained error budget.

The LMP7701 is offered in the space saving 5-Pin SOT23 and 8-Pin SOIC package. The LMP7702 comes in the 8-Pin SOIC and 8-Pin MSOP package. The LMP7704 is offered in the 14-Pin SOIC and 14-Pin TSSOP package. These small packages are ideal solutions for area constrained PC boards and portable electronics.

CAPACITIVE LOAD

The LMP7701/LMP7702/LMP7704 can each be connected as a non-inverting unity gain follower. This configuration is the most sensitive to capacitive loading.

The combination of a capacitive load placed on the output of an amplifier along with the amplifier's output impedance creates a phase lag which in turn reduces the phase margin of the amplifier. If the phase margin is significantly reduced, the response will be either underdamped or it will oscillate.

In order to drive heavier capacitive loads, an isolation resistor, R_{ISO} , in *Figure 1* should be used. By using this isolation resistor, the capacitive load is isolated from the amplifier's output, and hence, the pole caused by C_L is no longer in the feedback loop. The larger the value of R_{ISO} , the more stable the output voltage will be. If values of R_{ISO} are sufficiently large, the feedback loop will be stable, independent of the value of C_L . However, larger values of R_{ISO} result in reduced output swing and reduced output current drive.

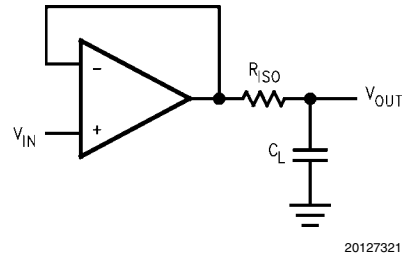

20127321

FIGURE 1. Isolating Capacitive Load

INPUT CAPACITANCE

CMOS input stages inherently have low input bias current and higher input referred voltage noise. The LMP7701/LMP7702/LMP7704 enhance this performance by having the low input bias current of only ± 200 fA, as well as, a very low input referred voltage noise of $9 \text{ nV}/\sqrt{\text{Hz}}$. In order to achieve this a larger input stage has been used. This larger input stage increases the input capacitance of the LMP7701/LMP7702/LMP7704. The typical value of this input capacitance, C_{IN} , for the LMP7701/LMP7702/LMP7704 is 25 pF. The input capacitance will interact with other impedances such as gain and feedback resistors, which are seen on the inputs of the amplifier, to form a pole. This pole will have little or no effect on the output of the amplifier at low frequencies and DC conditions, but will play a bigger role as the frequency increases. At higher frequencies, the presence of this pole will decrease phase margin and will also cause gain peaking. In order to compensate for the input capacitance, care must be taken in choosing the feedback resistors. In addition to being selective in picking values for the feedback resistor, a capacitor can be added to the feedback path to increase stability.

The DC gain of the circuit shown in *Figure 2* is simply $-R_2/R_1$.

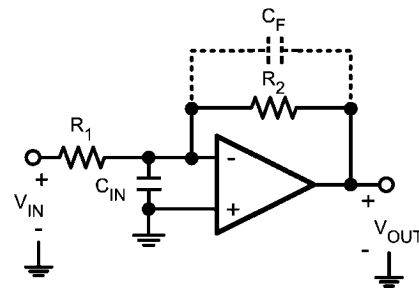

20127344

FIGURE 2. Compensating for Input Capacitance

For the time being, ignore C_F . The AC gain of the circuit in *Figure 2* can be calculated as follows:

$$\frac{V_{\text{OUT}}}{V_{\text{IN}}}(s) = \frac{-R_2/R_1}{\left[1 + \frac{s}{\left(\frac{A_0 R_1}{R_1 + R_2} \right)} + \frac{s^2}{\left(\frac{A_0}{C_{\text{IN}} R_2} \right)} \right]}$$

This equation is rearranged to find the location of the two poles:

$$P_{1,2} = \frac{-1}{2C_{IN}} \left[\frac{1}{R_1} + \frac{1}{R_2} \pm \sqrt{\left(\frac{1}{R_1} + \frac{1}{R_2}\right)^2 - \frac{4 A_0 C_{IN}}{R_2}} \right] \quad (1)$$

As shown in Equation 1, as values of R_1 and R_2 are increased, the magnitude of the poles is reduced, which in turn decreases the bandwidth of the amplifier. Whenever possible, it is best to choose smaller feedback resistors. Figure 3 shows the effect of the feedback resistor on the bandwidth of the LMP7701/LMP7702/LMP7704.

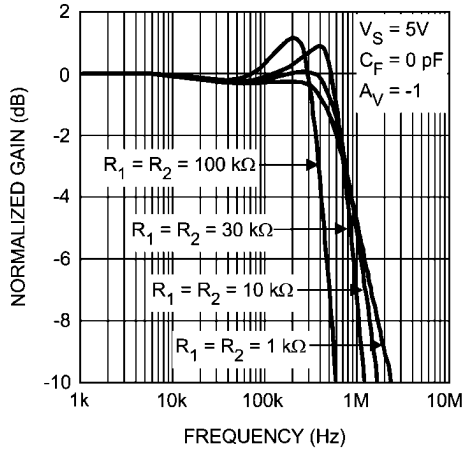

FIGURE 3. Closed Loop Gain vs. Frequency

Equation 1 has two poles. In most cases, it is the presence of pairs of poles that causes gain peaking. In order to eliminate this effect, the poles should be placed in Butterworth position, since poles in Butterworth position do not cause gain peaking. To achieve a Butterworth pair, the quantity under the square root in Equation 1 should be set to equal -1 . Using this fact and the relation between R_1 and R_2 , $R_2 = -A_V R_1$, the optimum value for R_1 can be found. This is shown in Equation 2. If R_1 is chosen to be larger than this optimum value, gain peaking will occur.

$$R_1 < \frac{(1 - A_V)^2}{2A_0 A_V C_{IN}} \quad (2)$$

In Figure 2, C_F is added to compensate for input capacitance and to increase stability. Additionally, C_F reduces or elimi-

ates the gain peaking that can be caused by having a larger feedback resistor. Figure 4 shows how C_F reduces gain peaking.

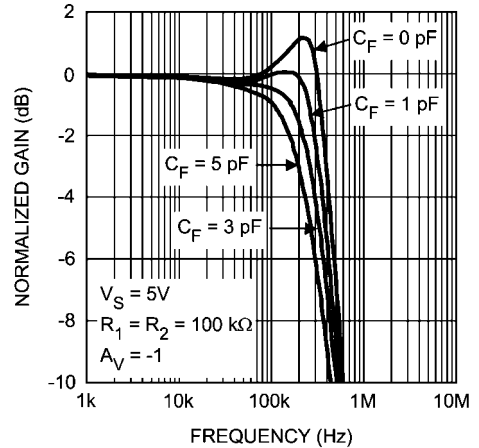

FIGURE 4. Closed Loop Gain vs. Frequency with Compensation

DIODES BETWEEN THE INPUTS

The LMP7701/LMP7702/LMP7704 have a set of anti-parallel diodes between the input pins, as shown in Figure 5. These diodes are present to protect the input stage of the amplifier. At the same time, they limit the amount of differential input voltage that is allowed on the input pins. A differential signal larger than one diode voltage drop might damage the diodes. The differential signal between the inputs needs to be limited to ± 300 mV or the input current needs to be limited to ± 10 mA.

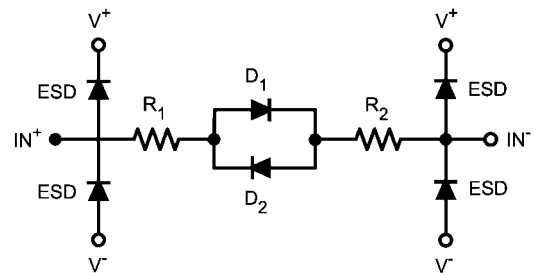
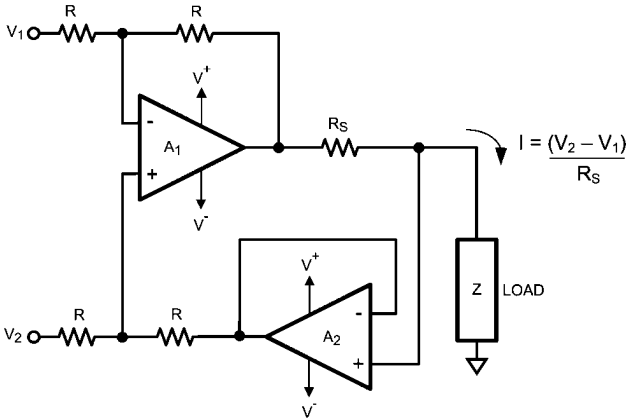

FIGURE 5. Input of LMP7701

PRECISION CURRENT SOURCE

The LMP7701/LMP7702/LMP7704 can each be used as a precision current source in many different applications. *Figure 6* shows a typical precision current source. This circuit implements a precision voltage controlled current source. Amplifier A1 is a differential amplifier that uses the voltage drop across R_S as the feedback signal. Amplifier A2 is a buffer that eliminates the error current from the load side of the R_S resistor that would flow in the feedback resistor if it were connected to the load side of the R_S resistor. In general, the circuit is stable as long as the closed loop bandwidth of amplifier A1 is greater than the closed loop bandwidth of amplifier A2. Note that if A1 and A2 are the same type of amplifiers, then the feedback around A1 will reduce its bandwidth compared to A2.



20127305

FIGURE 6. Precision Current Source

The equation for output current can be derived as follows:

$$\frac{V_2 R}{R + R} + \frac{(V_0 - I R_S) R}{R + R} = \frac{V_1 R}{R + R} + \frac{V_0 R}{R + R}$$

Solving for the current I results in the following equation:

$$I = \frac{V_2 - V_1}{R_S}$$

LOW INPUT VOLTAGE NOISE

The LMP7701/LMP7702/LMP7704 have the very low input voltage noise of 9 nV/√Hz. This input voltage noise can be further reduced by placing N amplifiers in parallel as shown in *Figure 7*. The total voltage noise on the output of this circuit

is divided by the square root of the number of amplifiers used in this parallel combination. This is because each individual amplifier acts as an independent noise source, and the average noise of independent sources is the quadrature sum of the independent sources divided by the number of sources. For N identical amplifiers, this means:

$$\begin{aligned} \text{REDUCED INPUT VOLTAGE NOISE} &= \frac{1}{N} \sqrt{e_{n1}^2 + e_{n2}^2 + \dots + e_{nN}^2} \\ &= \frac{1}{N} \sqrt{N e_n^2} = \frac{\sqrt{N}}{N} e_n \\ &= \frac{1}{\sqrt{N}} e_n \end{aligned}$$

Figure 7 shows a schematic of this input voltage noise reduction circuit. Typical resistor values are: $R_G = 10\Omega$, $R_F = 1\text{ k}\Omega$, and $R_O = 1\text{ k}\Omega$.

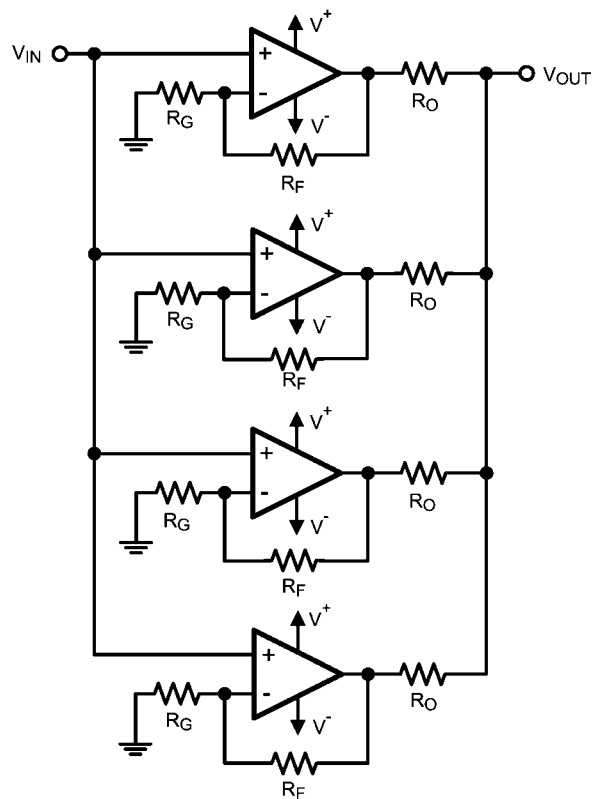

20127356

FIGURE 7. Noise Reduction Circuit

TOTAL NOISE CONTRIBUTION

The LMP7701/LMP7702/LMP7704 have very low input bias current, very low input current noise, and very low input voltage noise. As a result, these amplifiers are ideal choices for circuits with high impedance sensor applications.

Figure 8 shows the typical input noise of the LMP7701/LMP7702/LMP7704 as a function of source resistance where:

- e_n denotes the input referred voltage noise
- e_i is the voltage drop across source resistance due to input referred current noise or $e_i = R_S * i_n$
- e_t shows the thermal noise of the source resistance
- e_{ni} shows the total noise on the input.

Where:

$$e_{ni} = \sqrt{e_n^2 + e_i^2 + e_t^2}$$

The input current noise of the LMP7701/LMP7702/LMP7704 is so low that it will not become the dominant factor in the total noise unless source resistance exceeds 300 MΩ, which is an unrealistically high value.

As is evident in Figure 8, at lower R_S values, total noise is dominated by the amplifier's input voltage noise. Once R_S is larger than a few kilo-Ohms, then the dominant noise factor becomes the thermal noise of R_S . As mentioned before, the current noise will not be the dominant noise factor for any practical application.

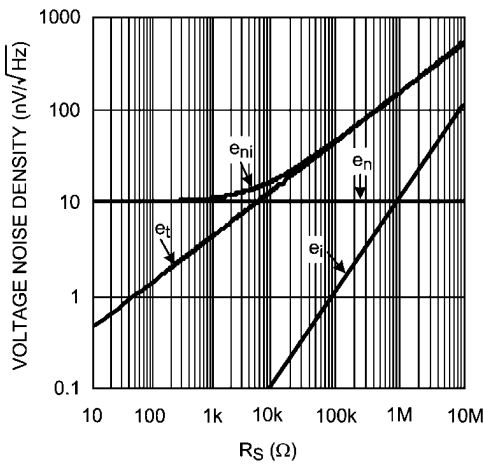

FIGURE 8. Total Input Noise

20127358

HIGH IMPEDANCE SENSOR INTERFACE

Many sensors have high source impedances that may range up to 10 MΩ. The output signal of sensors often needs to be amplified or otherwise conditioned by means of an amplifier. The input bias current of this amplifier can load the sensor's output and cause a voltage drop across the source resistance as shown in Figure 9, where $V_{IN+} = V_S - I_{BIAS} * R_S$

The last term, $I_{BIAS} * R_S$, shows the voltage drop across R_S . To prevent errors introduced to the system due to this voltage, an op amp with very low input bias current must be used with high impedance sensors. This is to keep the error contribution by $I_{BIAS} * R_S$ less than the input voltage noise of the amplifier, so that it will not become the dominant noise factor.

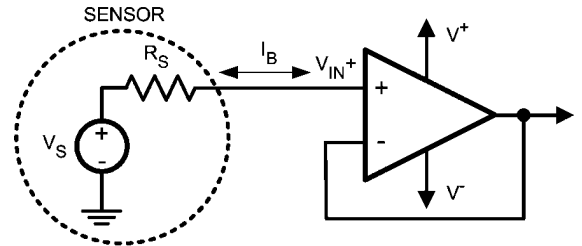

20127359

FIGURE 9. Noise Due to I_{BIAS}

pH electrodes are very high impedance sensors. As their name indicates, they are used to measure the pH of a solution. They usually do this by generating an output voltage which is proportional to the pH of the solution. pH electrodes are calibrated so that they have zero output for a neutral solution, pH = 7, and positive and negative voltages for acidic or alkaline solutions. This means that the output of a pH electrode is bipolar and has to be level shifted to be used in a single supply system. The rate of change of this voltage is usually shown in mV/pH and is different for different pH sensors. Temperature is also an important factor in a pH electrode reading. The output voltage of the sensor will change with temperature.

Figure 10 shows a typical output voltage spectrum of a pH electrode. Note that the exact values of output voltage will be different for different sensors. In this example, the pH electrode has an output voltage of 59.15 mV/pH at 25°C.

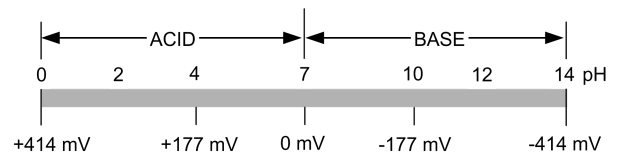

20127360

FIGURE 10. Output Voltage of a pH Electrode

The temperature dependence of a typical pH electrode is shown in Figure 11. As is evident, the output voltage changes with changes in temperature.

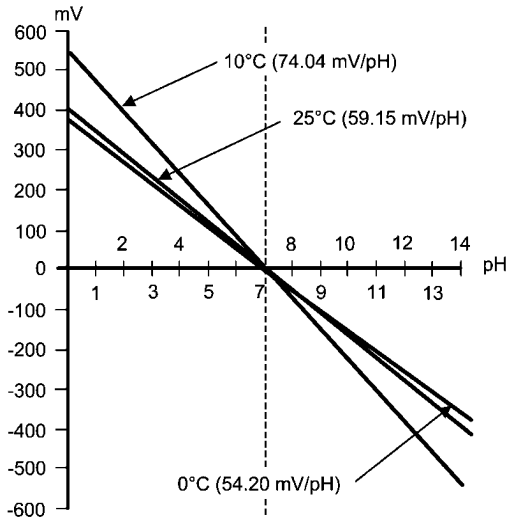

20127361

FIGURE 11. Temperature Dependence of a pH Electrode

The schematic shown in *Figure 12* is a typical circuit which can be used for pH measurement. The LM35 is a precision integrated circuit temperature sensor. This sensor is differentiated from similar products because it has an output voltage linearly proportional to Celsius measurement, without the need to convert the temperature to Kelvin. The LM35 is used to measure the temperature of the solution and feeds this reading to the Analog to Digital Converter, ADC. This information

is used by the ADC to calculate the temperature effects on the pH readings. The LM35 needs to have a resistor, R_T in *Figure 12*, to $-V^+$ in order to be able to read temperatures below 0°C . R_T is not needed if temperatures are not expected to go below zero.

The output of pH electrodes is usually large enough that it does not require much amplification; however, due to the very high impedance, the output of a pH electrode needs to be buffered before it can go to an ADC. Since most ADCs are operated on single supply, the output of the pH electrode also needs to be level shifted. Amplifier A1 buffers the output of the pH electrode with a moderate gain of +2, while A2 provides the level shifting. V_{OUT} at the output of A2 is given by: $V_{OUT} = -2V_{pH} + 1.024\text{V}$.

The LM4140A is a precision, low noise, voltage reference used to provide the level shift needed. The ADC used in this application is the ADC12032 which is a 12-bit, 2 channel converter with multiplexers on the inputs and a serial output. The 12-bit ADC enables users to measure pH with an accuracy of 0.003 of a pH unit. Adequate power supply bypassing and grounding is extremely important for ADCs. Recommended bypass capacitors are shown in *Figure 12*. It is common to share power supplies between different components in a circuit. To minimize the effects of power supply ripples caused by other components, the op amps need to have bypass capacitors on the supply pins. Using the same value capacitors as those used with the ADC are ideal. The combination of these three values of capacitors ensures that AC noise present on the power supply line is grounded and does not interfere with the amplifiers' signal.

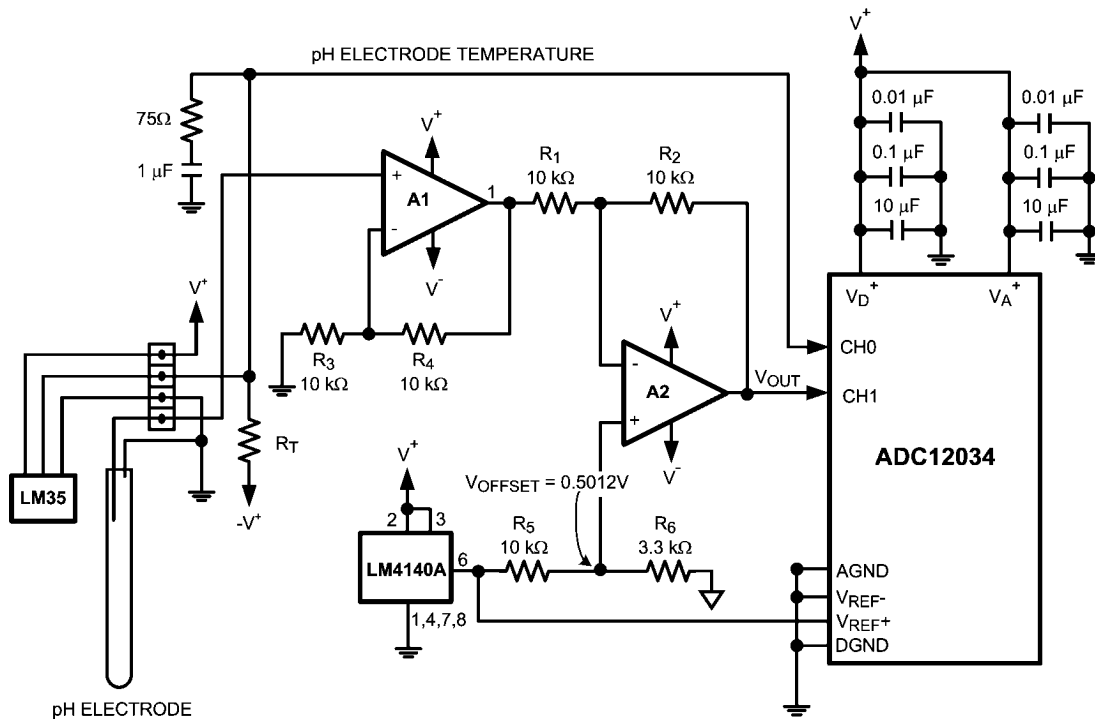

20127362

FIGURE 12. pH Measurement Circuit

Physical Dimensions inches (millimeters) unless otherwise noted

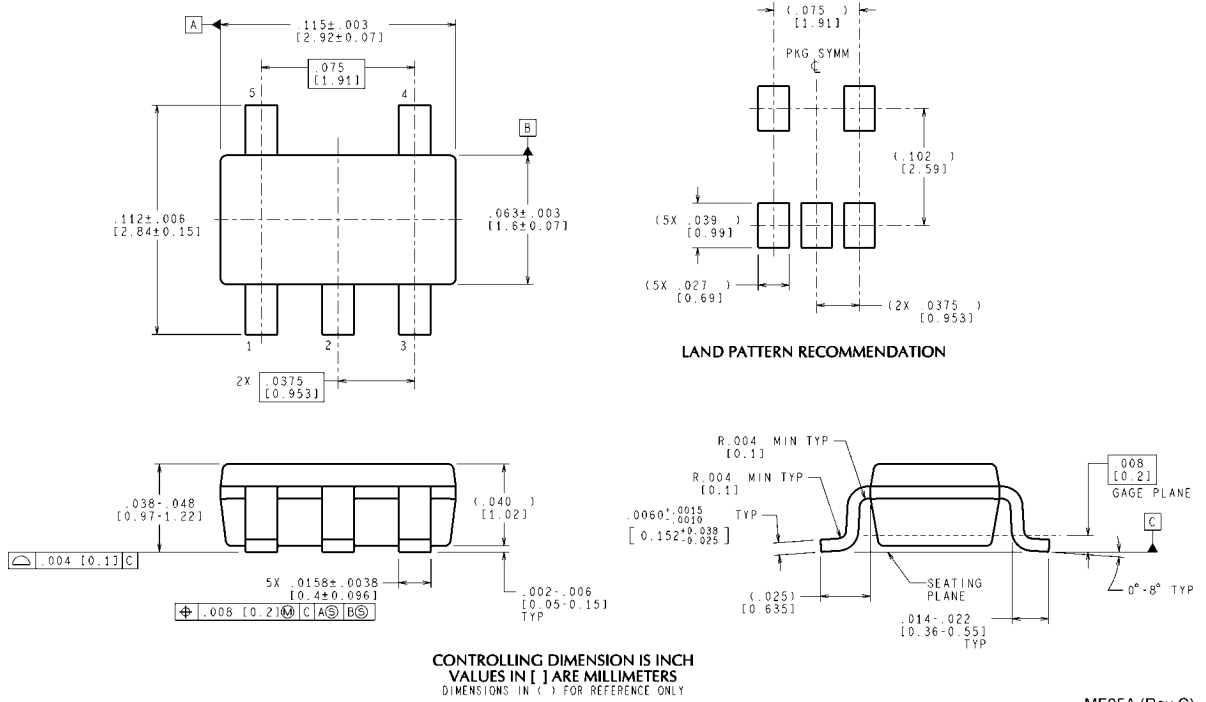

5-Pin SOT23
NS Package Number MF05A

MF05A (Rev C)

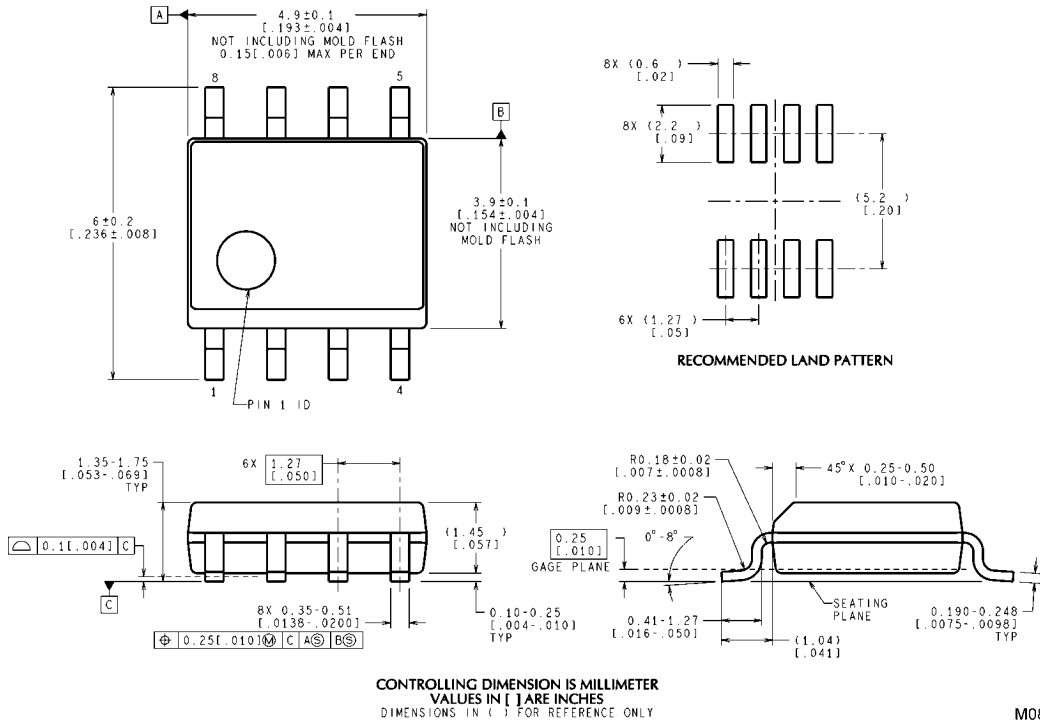

8-Pin SOIC
NS Package Number M08A

M08A (Rev L)

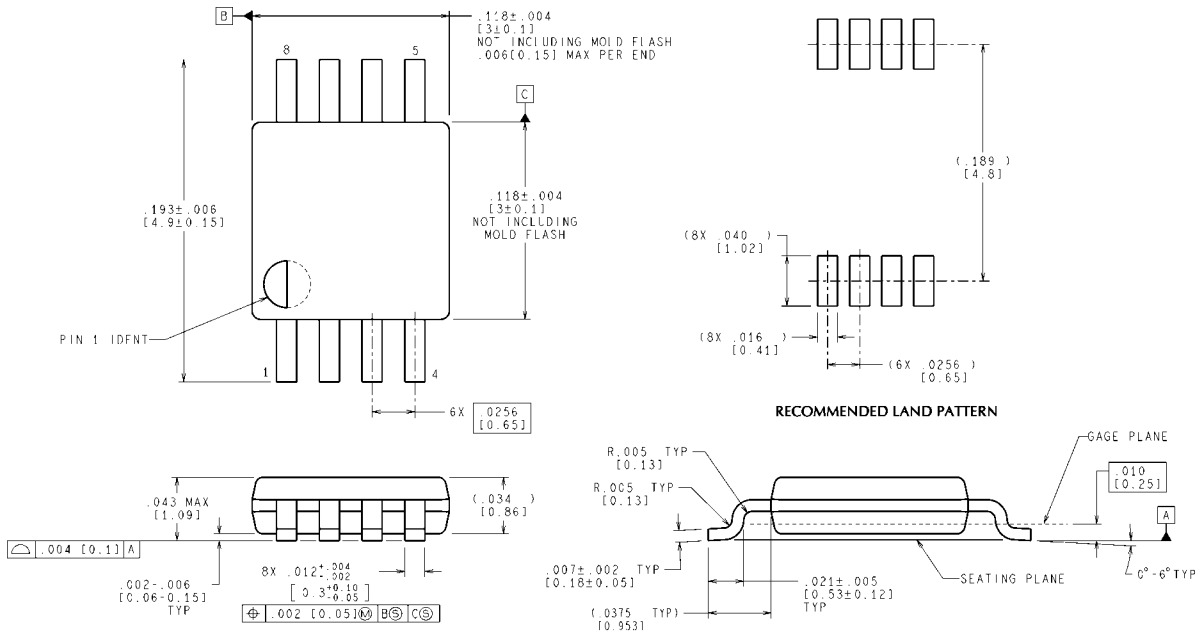

CONTROLLING DIMENSION IS INCH
VALUES IN [] ARE MILLIMETERS

MUA08A (Rev F)

8-Pin MSOP
NS Package Number MUA08A

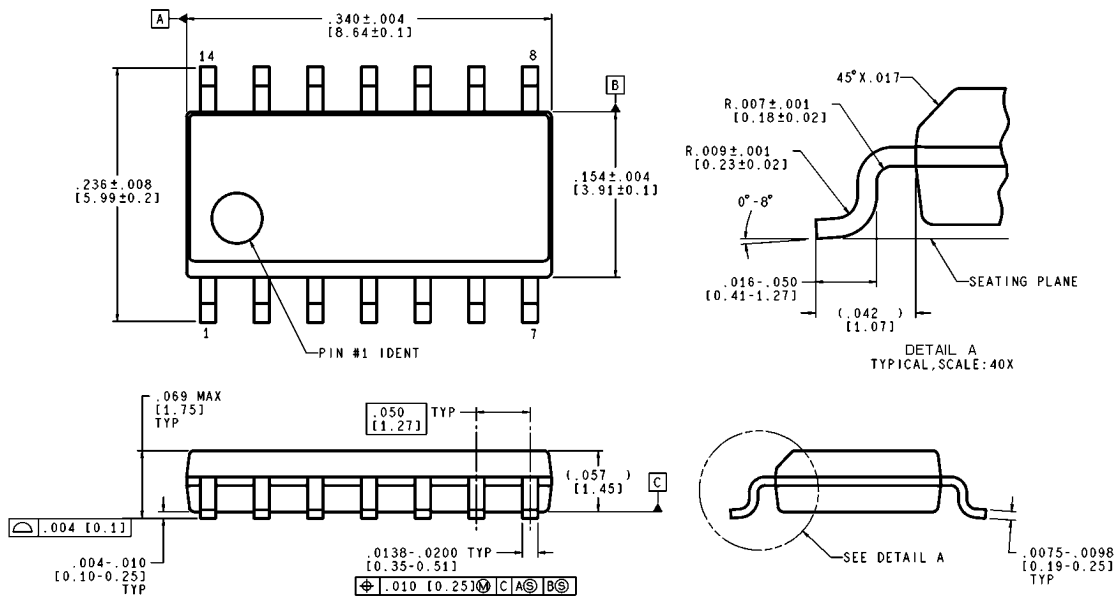

CONTROLLING DIMENSION IS INCH
VALUES IN [] ARE MILLIMETERS

M14A (Rev J)

14-Pin SOIC
NS Package Number M14A

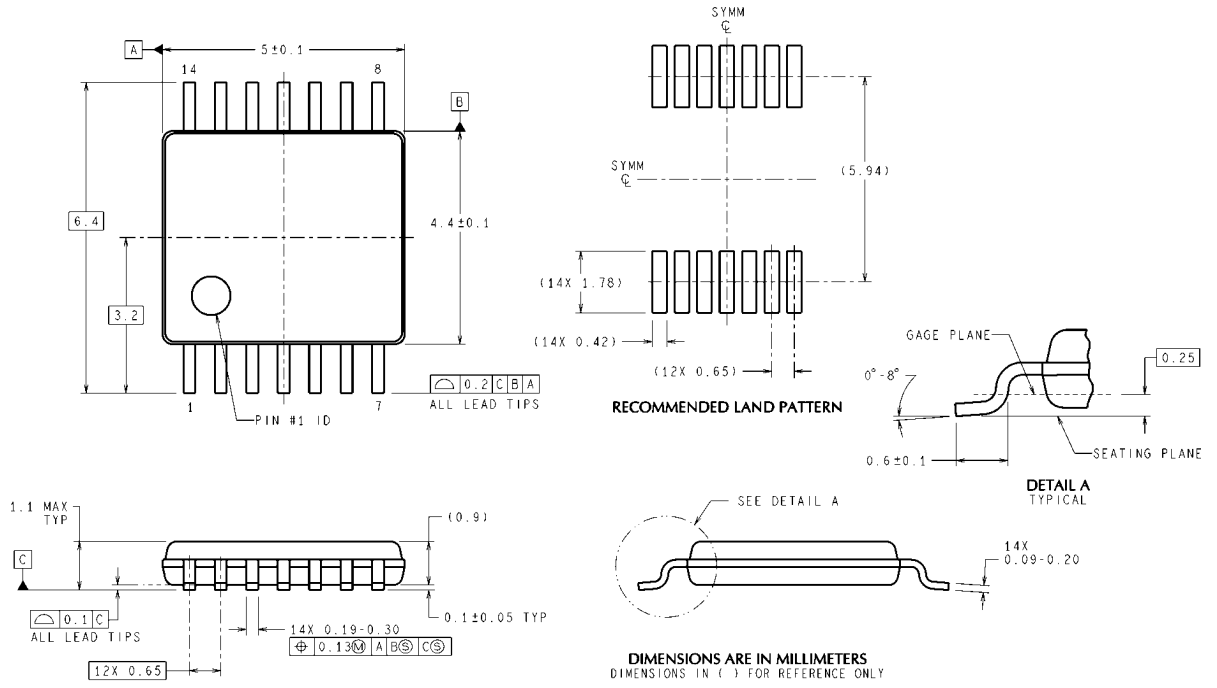

**14-Pin TSSOP
NS Package Number MTC14**

MTC14 (Rev D)

Notes

Notes

For more National Semiconductor product information and proven design tools, visit the following Web sites at:

Products		Design Support	
Amplifiers	www.national.com/amplifiers	WEBENCH	www.national.com/webench
Audio	www.national.com/audio	Analog University	www.national.com/AU
Clock Conditioners	www.national.com/timing	App Notes	www.national.com/appnotes
Data Converters	www.national.com/adc	Distributors	www.national.com/contacts
Displays	www.national.com/displays	Green Compliance	www.national.com/quality/green
Ethernet	www.national.com/ethernet	Packaging	www.national.com/packaging
Interface	www.national.com/interface	Quality and Reliability	www.national.com/quality
LVDS	www.national.com/lvds	Reference Designs	www.national.com/refdesigns
Power Management	www.national.com/power	Feedback	www.national.com/feedback
Switching Regulators	www.national.com/switchers		
LDOs	www.national.com/ldo		
LED Lighting	www.national.com/led		
PowerWise	www.national.com/powerwise		
Serial Digital Interface (SDI)	www.national.com/sdi		
Temperature Sensors	www.national.com/tempsensors		
Wireless (PLL/VCO)	www.national.com/wireless		

THE CONTENTS OF THIS DOCUMENT ARE PROVIDED IN CONNECTION WITH NATIONAL SEMICONDUCTOR CORPORATION ("NATIONAL") PRODUCTS. NATIONAL MAKES NO REPRESENTATIONS OR WARRANTIES WITH RESPECT TO THE ACCURACY OR COMPLETENESS OF THE CONTENTS OF THIS PUBLICATION AND RESERVES THE RIGHT TO MAKE CHANGES TO SPECIFICATIONS AND PRODUCT DESCRIPTIONS AT ANY TIME WITHOUT NOTICE. NO LICENSE, WHETHER EXPRESS, IMPLIED, ARISING BY ESTOPPEL OR OTHERWISE, TO ANY INTELLECTUAL PROPERTY RIGHTS IS GRANTED BY THIS DOCUMENT.

TESTING AND OTHER QUALITY CONTROLS ARE USED TO THE EXTENT NATIONAL DEEMS NECESSARY TO SUPPORT NATIONAL'S PRODUCT WARRANTY. EXCEPT WHERE MANDATED BY GOVERNMENT REQUIREMENTS, TESTING OF ALL PARAMETERS OF EACH PRODUCT IS NOT NECESSARILY PERFORMED. NATIONAL ASSUMES NO LIABILITY FOR APPLICATIONS ASSISTANCE OR BUYER PRODUCT DESIGN. BUYERS ARE RESPONSIBLE FOR THEIR PRODUCTS AND APPLICATIONS USING NATIONAL COMPONENTS. PRIOR TO USING OR DISTRIBUTING ANY PRODUCTS THAT INCLUDE NATIONAL COMPONENTS, BUYERS SHOULD PROVIDE ADEQUATE DESIGN, TESTING AND OPERATING SAFEGUARDS.

EXCEPT AS PROVIDED IN NATIONAL'S TERMS AND CONDITIONS OF SALE FOR SUCH PRODUCTS, NATIONAL ASSUMES NO LIABILITY WHATSOEVER, AND NATIONAL DISCLAIMS ANY EXPRESS OR IMPLIED WARRANTY RELATING TO THE SALE AND/OR USE OF NATIONAL PRODUCTS INCLUDING LIABILITY OR WARRANTIES RELATING TO FITNESS FOR A PARTICULAR PURPOSE, MERCHANTABILITY, OR INFRINGEMENT OF ANY PATENT, COPYRIGHT OR OTHER INTELLECTUAL PROPERTY RIGHT.

LIFE SUPPORT POLICY

NATIONAL'S PRODUCTS ARE NOT AUTHORIZED FOR USE AS CRITICAL COMPONENTS IN LIFE SUPPORT DEVICES OR SYSTEMS WITHOUT THE EXPRESS PRIOR WRITTEN APPROVAL OF THE CHIEF EXECUTIVE OFFICER AND GENERAL COUNSEL OF NATIONAL SEMICONDUCTOR CORPORATION. As used herein:

Life support devices or systems are devices which (a) are intended for surgical implant into the body, or (b) support or sustain life and whose failure to perform when properly used in accordance with instructions for use provided in the labeling can be reasonably expected to result in a significant injury to the user. A critical component is any component in a life support device or system whose failure to perform can be reasonably expected to cause the failure of the life support device or system or to affect its safety or effectiveness.

National Semiconductor and the National Semiconductor logo are registered trademarks of National Semiconductor Corporation. All other brand or product names may be trademarks or registered trademarks of their respective holders.

Copyright© 2008 National Semiconductor Corporation

For the most current product information visit us at www.national.com



National Semiconductor Americas Technical Support Center
 Email: support@nsc.com
 Tel: 1-800-272-9959

National Semiconductor Europe Technical Support Center
 Email: europe.support@nsc.com
 German Tel: +49 (0) 180 5010 771
 English Tel: +44 (0) 870 850 4288

National Semiconductor Asia Pacific Technical Support Center
 Email: ap.support@nsc.com

National Semiconductor Japan Technical Support Center
 Email: jpn.feedback@nsc.com

IMPORTANT NOTICE

Texas Instruments Incorporated and its subsidiaries (TI) reserve the right to make corrections, modifications, enhancements, improvements, and other changes to its products and services at any time and to discontinue any product or service without notice. Customers should obtain the latest relevant information before placing orders and should verify that such information is current and complete. All products are sold subject to TI's terms and conditions of sale supplied at the time of order acknowledgment.

TI warrants performance of its hardware products to the specifications applicable at the time of sale in accordance with TI's standard warranty. Testing and other quality control techniques are used to the extent TI deems necessary to support this warranty. Except where mandated by government requirements, testing of all parameters of each product is not necessarily performed.

TI assumes no liability for applications assistance or customer product design. Customers are responsible for their products and applications using TI components. To minimize the risks associated with customer products and applications, customers should provide adequate design and operating safeguards.

TI does not warrant or represent that any license, either express or implied, is granted under any TI patent right, copyright, mask work right, or other TI intellectual property right relating to any combination, machine, or process in which TI products or services are used. Information published by TI regarding third-party products or services does not constitute a license from TI to use such products or services or a warranty or endorsement thereof. Use of such information may require a license from a third party under the patents or other intellectual property of the third party, or a license from TI under the patents or other intellectual property of TI.

Reproduction of TI information in TI data books or data sheets is permissible only if reproduction is without alteration and is accompanied by all associated warranties, conditions, limitations, and notices. Reproduction of this information with alteration is an unfair and deceptive business practice. TI is not responsible or liable for such altered documentation. Information of third parties may be subject to additional restrictions.

Resale of TI products or services with statements different from or beyond the parameters stated by TI for that product or service voids all express and any implied warranties for the associated TI product or service and is an unfair and deceptive business practice. TI is not responsible or liable for any such statements.

TI products are not authorized for use in safety-critical applications (such as life support) where a failure of the TI product would reasonably be expected to cause severe personal injury or death, unless officers of the parties have executed an agreement specifically governing such use. Buyers represent that they have all necessary expertise in the safety and regulatory ramifications of their applications, and acknowledge and agree that they are solely responsible for all legal, regulatory and safety-related requirements concerning their products and any use of TI products in such safety-critical applications, notwithstanding any applications-related information or support that may be provided by TI. Further, Buyers must fully indemnify TI and its representatives against any damages arising out of the use of TI products in such safety-critical applications.

TI products are neither designed nor intended for use in military/aerospace applications or environments unless the TI products are specifically designated by TI as military-grade or "enhanced plastic." Only products designated by TI as military-grade meet military specifications. Buyers acknowledge and agree that any such use of TI products which TI has not designated as military-grade is solely at the Buyer's risk, and that they are solely responsible for compliance with all legal and regulatory requirements in connection with such use.

TI products are neither designed nor intended for use in automotive applications or environments unless the specific TI products are designated by TI as compliant with ISO/TS 16949 requirements. Buyers acknowledge and agree that, if they use any non-designated products in automotive applications, TI will not be responsible for any failure to meet such requirements.

Following are URLs where you can obtain information on other Texas Instruments products and application solutions:

Products

Audio	www.ti.com/audio
Amplifiers	amplifier.ti.com
Data Converters	dataconverter.ti.com
DLP® Products	www.dlp.com
DSP	dsp.ti.com
Clocks and Timers	www.ti.com/clocks
Interface	interface.ti.com
Logic	logic.ti.com
Power Mgmt	power.ti.com
Microcontrollers	microcontroller.ti.com
RFID	www.ti-rfid.com
OMAP Mobile Processors	www.ti.com/omap
Wireless Connectivity	www.ti.com/wirelessconnectivity

Applications

Communications and Telecom	www.ti.com/communications
Computers and Peripherals	www.ti.com/computers
Consumer Electronics	www.ti.com/consumer-apps
Energy and Lighting	www.ti.com/energy
Industrial	www.ti.com/industrial
Medical	www.ti.com/medical
Security	www.ti.com/security
Space, Avionics and Defense	www.ti.com/space-avionics-defense
Transportation and Automotive	www.ti.com/automotive
Video and Imaging	www.ti.com/video

TI E2E Community Home Page

e2e.ti.com

Mailing Address: Texas Instruments, Post Office Box 655303, Dallas, Texas 75265
Copyright © 2011, Texas Instruments Incorporated