

COSMO High Voltage, Solid State Relay-MOSFET Output KAQV212/212A

UL 1577/ UL 508 (File No.E108430), FI EN60950 (File No.F113698)

Features

1. Normally Open, Single Pole Single Throw
2. Control 60VAC or DC Voltage
3. Switch 400mA Loads
4. LED control Current, 5mA
5. Low ON-Resistance
6. dv/dt , >500V/ms
7. Isolation Test Voltage, 3750VACrms

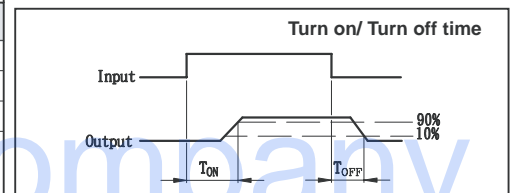
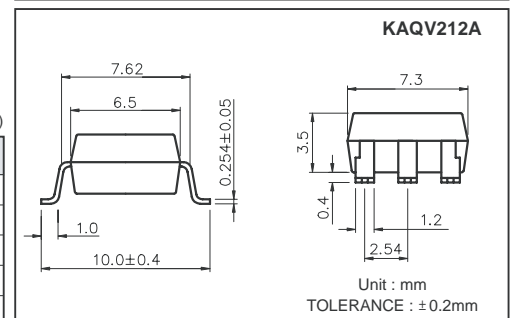
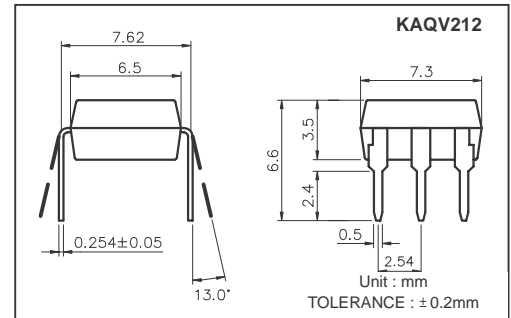

Absolute Maximum Ratings

(Ta=25°C)

Emitter (Input)		Detector (Output)	
Reverse Voltage.....	5.0V	Output Breakdown Voltage	±60V
Continuous Forward Current	50mA	Continuous Load Current	±400mA
Peak Forward Current	1A	Power Dissipation	500mW
Power Dissipation	100mW		
Derate Linearly from 25°C	1.3mW/°C		
General Characteristics			
Isolation Test Voltage.....	3750VACrms	Storage Temperature Range ...	-40°C to +125°C
Isolation Resistance		Operating Temperature Range....	-30°C to +85°C
Vio=500V, Ta=25°C	>10 ¹⁰ Ω	Junction Temperature.....	100°C
Total Power Dissipation	550mW	Soldering Temperature,	
Derate Linearly from 25°C	2.5mW/°C	2mm from case, 10 sec	260°C

Electro-optical Characteristics

(Ta=25°C)

Parameter	Symbol	Conditions	Min.	Typ.	Max.	Unit
Emitter (Input)						
Forward Voltage	V _F	I _F = 10mA		1.2	1.5	V
Operation Input Current	I _{FON}	V _L = ±20V, I _L = 100mA, t = 10ms			5	mA
Recovery Input Current	I _{FOFF}	V _L = ±20V, I _L ≤ 5uA	0.2			mA
Detector (Output)						
Output Breakdown Voltage	V _B	I _B = 50uA	60			V
Output Off-State Leakage	I _{TOFF}	V _T = 60V, I _F = 0mA		0.2	1	uA
I/O Capacitance	C _{ISO}	I _F = 0, f = 1MHz		0.8		pF
ON Resistance	Connection	A	I _L = 100mA, I _F = 10mA	0.83	2.50	Ω
		B		0.44	1.25	
		C		0.25	0.63	
Turn-On Time	T _{ON}	I _F = 10mA, V _L = ±20V		0.2	1.5	ms
Turn-Off Time	T _{OFF}	t = 10ms, I _L = ±100mA		0.3	1.5	ms

Schematic and Wiring Diagrams

Type	Schematic	Output configuration	Load	Connection	Wiring Diagrams
KAQV212 & KAQV212A		1a	AC/DC	A	
			DC	B	
			DC	C	

Data Curve

Fig.1 Load current vs. ambient temperature
Allowable ambient temperature:
-40°C to +85°C

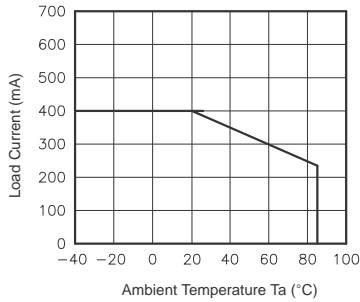

Fig.2 On resistance vs. ambient temperature
Across terminals 4 and 6 pin
LED current: 5mA
Continuous load current: 130mA(DC)

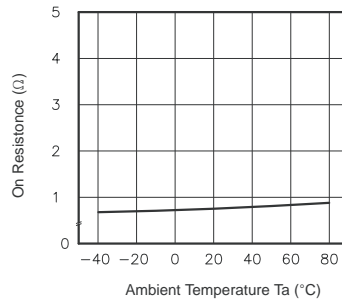

Fig.3 Turn on time vs. ambient temperature
Load voltage 60V(DC)
LED current: 5mA
Continuous load current: 130mA(DC)

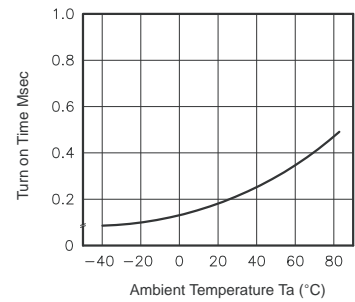

Fig.4 Turn off time vs. ambient temperature
LED current: 5mA; Load voltage:
60V(DC)
Continuous load current: 130mA(DC)

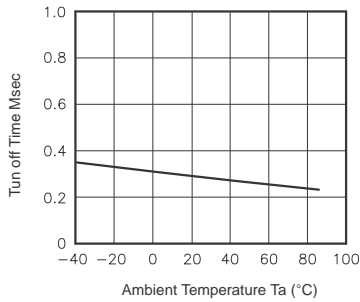

Fig.5 LED operate vs. ambient temperature
Load voltage 60V(DC)
Continuous load current: 130mA(DC)

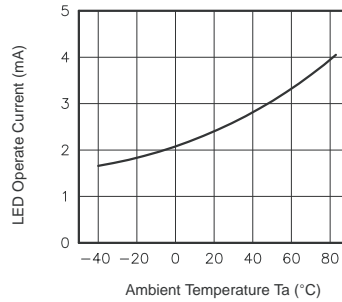

Fig.6 LED turn off current vs. ambient temperature
Load voltage 60V(DC)
Continuous load current: 130mA(DC)

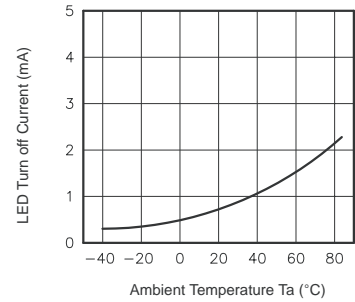

Fig.7 LED dropout voltage vs. ambient temperature
LED current: 5 to 50mA

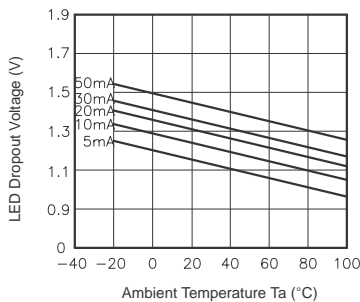

Fig.8 Voltage vs. current characteristics of output at MOS FET portion
Measured portion: across terminals 4 and 6 pin
Ambient temperature: 25°C

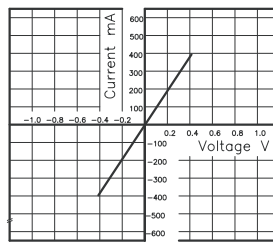

Fig.9 Off state leakage current
Across terminals 4 and 6 pin
Ambient temperature: 25°C

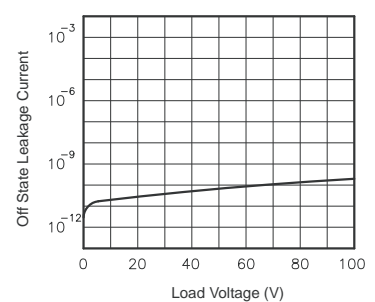

Fig.10 LED forward current vs. turn on time
Across terminals 4 and 6 pin;
Load voltage: 60V (DC);
Continuous load current: 130mA (DC);
Ambient temperature: 25°C

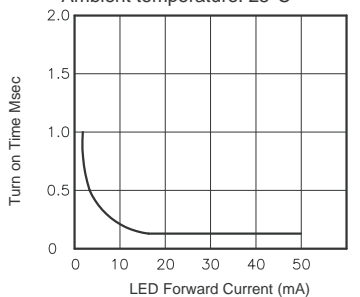

Fig.11 LED forward current vs. turn off time
Across terminals 4 and 6 pin;
Load voltage: 60V (DC);
Continuous load current: 130mA (DC);
Ambient temperature: 25°C

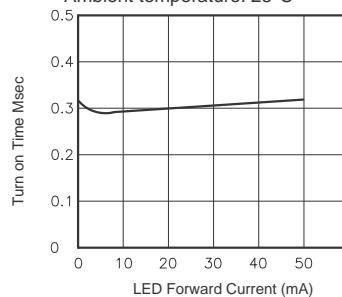

Fig.12 Applied voltage vs. output capacitance
Across terminals 4 and 6 pin
Frequency: 1MHz
Ambient temperature: 25°C

