

2N7000 / 2N7002 / NDS7002A

N-Channel Enhancement Mode Field Effect Transistor

General Description

These N-Channel enhancement mode field effect transistors are produced using Fairchild's proprietary, high cell density, DMOS technology. These products have been designed to minimize on-state resistance while provide rugged, reliable, and fast switching performance. They can be used in most applications requiring up to 400mA DC and can deliver pulsed currents up to 2A. These products are particularly suited for low voltage, low current applications such as small servo motor control, power MOSFET gate drivers, and other switching applications.

Features

- High density cell design for low $R_{DS(ON)}$
- Voltage controlled small signal switch.
- Rugged and reliable.
- High saturation current capability.

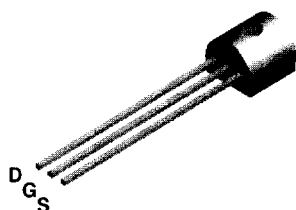

TO-92
2N7000

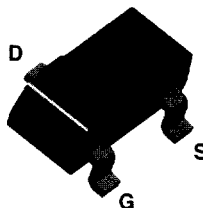

SOT-23
(TO-236AB)
2N7002/NDS7002A

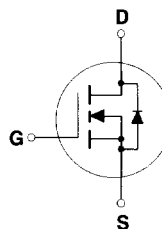

Absolute Maximum Ratings

$T_A = 25^\circ\text{C}$ unless otherwise noted

Symbol	Parameter	2N7000	2N7002	NDS7002A	Units
V_{DS}	Drain-Source Voltage	60			V
V_{DGR}	Drain-Gate Voltage ($R_{GS} \leq 1 \text{ M}\Omega$)	60			V
V_{GSS}	Gate-Source Voltage - Continuous	± 20			V
	- Non Repetitive ($t_p < 50 \text{ s}$)	± 40			
I_D	Maximum Drain Current - Continuous	200	115	280	mA
	- Pulsed	500	800	1500	
P_D	Maximum Power Dissipation	400	200	300	mW
	Derated above 25°C	3.2	1.6	2.4	
T_J, T_{STG}	Operating and Storage Temperature Range	-55 to 150			$^\circ\text{C}$
T_L	Maximum Lead Temperature for Soldering Purposes, 1/16" from Case for 10 Seconds	300			$^\circ\text{C}$

THERMAL CHARACTERISTICS

$R_{\theta JA}$	Thermal Resistance, Junction-to-Ambient	312.5	625	417	$^\circ\text{C/W}$

2N7000/2N7002/NDS7002A

5

Electrical Characteristics ($T_A = 25^\circ\text{C}$ unless otherwise noted)

Symbol	Parameter	Conditions	Type	Min	Typ	Max	Units
OFF CHARACTERISTICS							
BV_{DSS}	Drain-Source Breakdown Voltage	$V_{GS} = 0\text{ V}, I_D = 10\ \mu\text{A}$	All	60			V
I_{DSS}	Zero Gate Voltage Drain Current	$V_{DS} = 48\text{ V}, V_{GS} = 0\text{ V}$	2N7000			1	μA
		$T_J = 125^\circ\text{C}$				1	mA
		$V_{DS} = 60\text{ V}, V_{GS} = 0\text{ V}$	2N7002 NDS7002A			1	μA
		$T_J = 125^\circ\text{C}$				0.5	mA
I_{GSSF}	Gate - Body Leakage, Forward	$V_{GS} = 15\text{ V}, V_{DS} = 0\text{ V}$	2N7000			10	nA
		$V_{GS} = 20\text{ V}, V_{DS} = 0\text{ V}$	2N7002 NDS7002A			100	nA
I_{GSSR}	Gate - Body Leakage, Reverse	$V_{GS} = -15\text{ V}, V_{DS} = 0\text{ V}$	2N7000			-10	nA
		$V_{GS} = -20\text{ V}, V_{DS} = 0\text{ V}$	2N7002 NDS7002A			-100	nA

ON CHARACTERISTICS (Note 1)

$V_{GS(TH)}$	Gate Threshold Voltage	$V_{DS} = V_{GS}, I_D = 1\text{ mA}$	2N7000	0.8	2.1	3	V
		$V_{DS} = V_{GS}, I_D = 250\ \mu\text{A}$	2N7002 NDS7002A	1	2.1	2.5	
$R_{DS(ON)}$	Static Drain-Source On-Resistance	$V_{GS} = 10\text{ V}, I_D = 500\text{ mA}$	2N7000		1.2	5	Ω
		$T_J = 125^\circ\text{C}$			1.9	9	
		$V_{GS} = 4.5\text{ V}, I_D = 75\text{ mA}$		1.8	5.3		
		$V_{GS} = 10\text{ V}, I_D = 500\text{ mA}$	2N7002		1.2	7.5	
		$T_J = 100^\circ\text{C}$			1.7	13.5	
		$V_{GS} = 5.0\text{ V}, I_D = 50\text{ mA}$		1.7	7.5		
		$T_J = 100^\circ\text{C}$		2.4	13.5		
		$V_{GS} = 10\text{ V}, I_D = 500\text{ mA}$	NDS7002A		1.2	2	
$T_J = 125^\circ\text{C}$		2		3.5			
$V_{DS(ON)}$	Drain-Source On-Voltage	$V_{GS} = 10\text{ V}, I_D = 500\text{ mA}$	2N7000		0.6	2.5	V
		$V_{GS} = 4.5\text{ V}, I_D = 75\text{ mA}$			0.14	0.4	
		$V_{GS} = 10\text{ V}, I_D = 500\text{ mA}$	2N7002		0.6	3.75	
		$V_{GS} = 5.0\text{ V}, I_D = 50\text{ mA}$			0.09	1.5	
		$V_{GS} = 10\text{ V}, I_D = 500\text{ mA}$	NDS7002A		0.6	1	
		$V_{GS} = 5.0\text{ V}, I_D = 50\text{ mA}$			0.09	0.15	

Electrical Characteristics (T _A = 25°C unless otherwise noted)							
Symbol	Parameter	Conditions	Type	Min	Typ	Max	Units
ON CHARACTERISTICS Continued (Note 1)							
I _{D(ON)}	On-State Drain Current	V _{GS} = 4.5 V, V _{DS} = 10 V	2N7000	75	600		mA
		V _{GS} = 10 V, V _{DS} ≥ 2 V _{D(ON)}	2N7002	500	2700		
		V _{GS} = 10 V, V _{DS} ≥ 2 V _{D(ON)}	NDS7002A	500	2700		
g _{FS}	Forward Transconductance	V _{DS} = 10 V, I _D = 200 mA	2N7000	100	320		mS
		V _{DS} ≥ 2 V _{D(ON)} , I _D = 200 mA	2N7002	80	320		
		V _{DS} ≥ 2 V _{D(ON)} , I _D = 200 mA	NDS7002A	80	320		
DYNAMIC CHARACTERISTICS							
C _{iss}	Input Capacitance	V _{DS} = 25 V, V _{GS} = 0 V, f = 1.0 MHz	All		20	50	pF
C _{oss}	Output Capacitance		All		11	25	pF
C _{rss}	Reverse Transfer Capacitance		All		4	5	pF
t _{on}	Turn-On Time	V _{DD} = 15 V, R _L = 25 Ω, I _D = 500 mA, V _{GS} = 10 V, R _{GEN} = 25	2N7000			10	ns
		V _{DD} = 30 V, R _L = 150 Ω, I _D = 200 mA, V _{GS} = 10 V, R _{GEN} = 25 Ω	2N700 NDS7002A			20	
t _{off}	Turn-Off Time	V _{DD} = 15 V, R _L = 25 Ω, I _D = 500 mA, V _{GS} = 10 V, R _{GEN} = 25	2N7000			10	ns
		V _{DD} = 30 V, R _L = 150 Ω, I _D = 200 mA, V _{GS} = 10 V, R _{GEN} = 25 Ω	2N700 NDS7002A			20	
DRAIN-SOURCE DIODE CHARACTERISTICS AND MAXIMUM RATINGS							
I _S	Maximum Continuous Drain-Source Diode Forward Current		2N7002			115	mA
			NDS7002A			280	
I _{SM}	Maximum Pulsed Drain-Source Diode Forward Current		2N7002			0.8	A
			NDS7002A			1.5	
V _{SD}	Drain-Source Diode Forward Voltage	V _{GS} = 0 V, I _S = 115 mA (Note 1)	2N7002		0.88	1.5	V
		V _{GS} = 0 V, I _S = 400 mA (Note 1)	NDS7002A		0.88	1.2	
Note: 1. Pulse Test: Pulse Width ≤ 300 μs. Duty Cycle ≤ 2.0%.							

Typical Electrical Characteristics

2N7000 / 2N7002 / NDS7002A

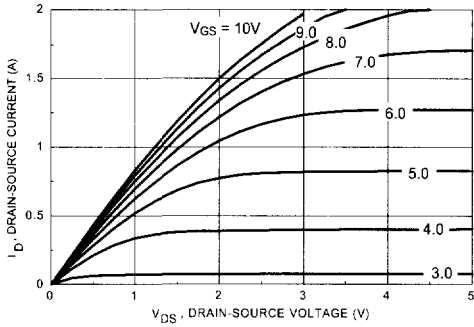

Figure 1. On-Region Characteristics.

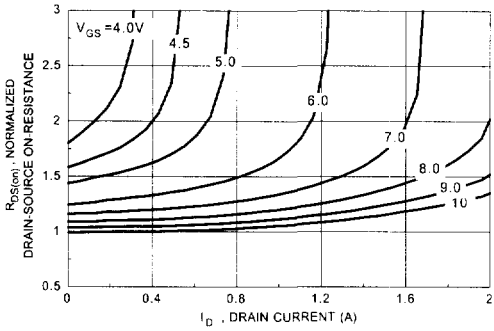

Figure 2. On-Resistance Variation with Gate Voltage and Drain Current

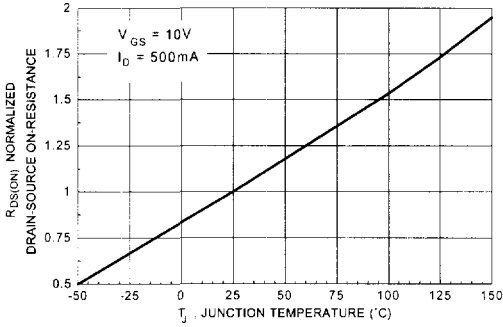

Figure 3. On-Resistance Variation with Temperature

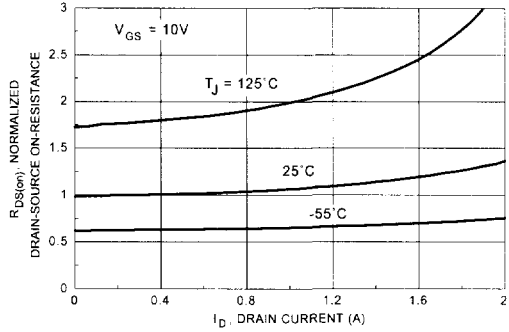

Figure 4. On-Resistance Variation with Drain Current and Temperature

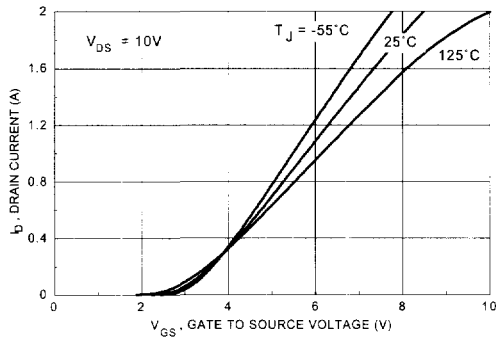

Figure 5. Transfer Characteristics.

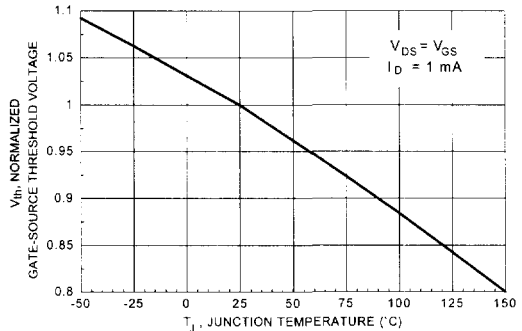

Figure 6. Gate Threshold Variation with Temperature.

Typical Electrical Characteristics (continued)

2N7000 / 2N7002 / NDS7002A

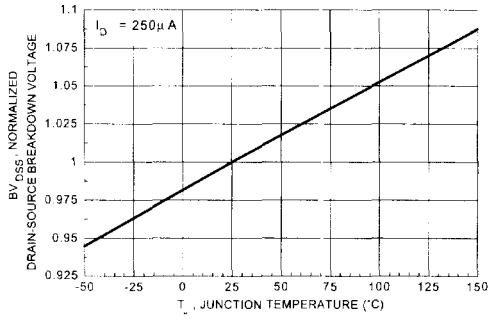

Figure 7. Breakdown Voltage Variation with Temperature.

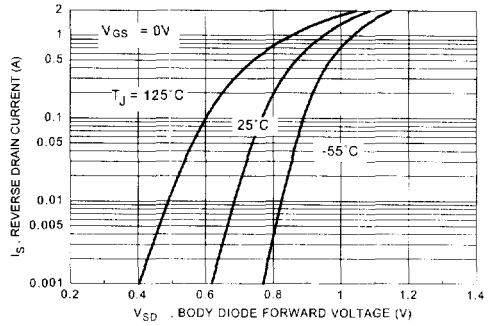

Figure 8. Body Diode Forward Voltage Variation with Current and Temperature.

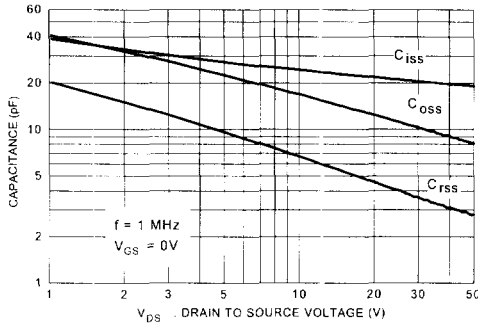

Figure 9. Capacitance Characteristics

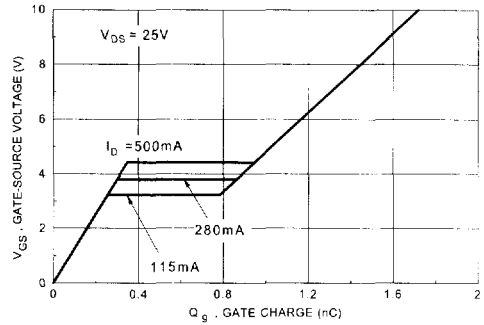

Figure 10. Gate Charge Characteristics.

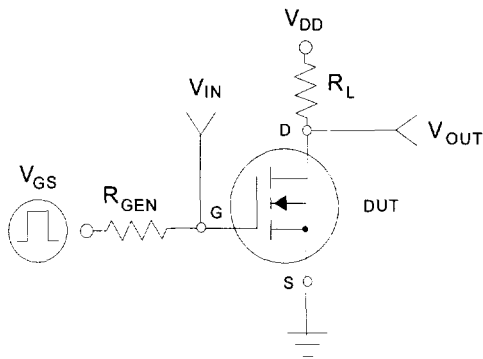

Figure 11. Switching Test Circuit.

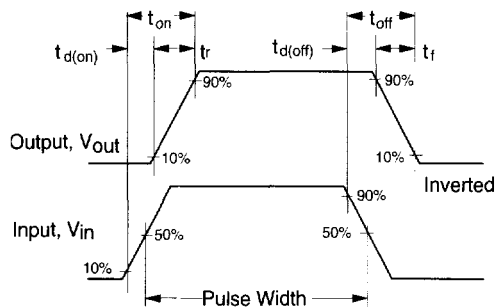

Figure 12. Switching Waveforms.

Typical Electrical Characteristics (continued)

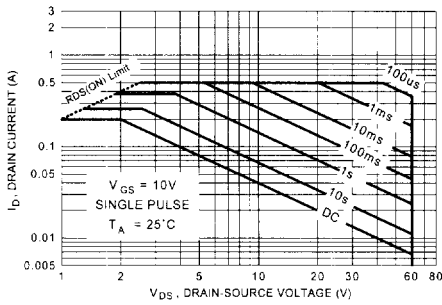

Figure 13. 2N7000 Maximum Safe Operating Area.

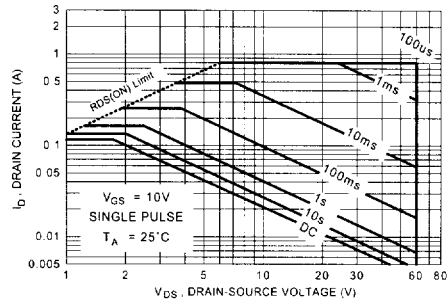

Figure 14. 2N7002 Maximum Safe Operating Area.

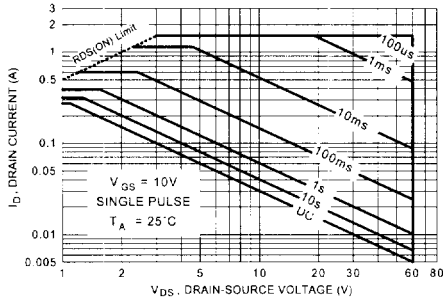

Figure 15. NDS7000A Maximum Safe Operating Area.

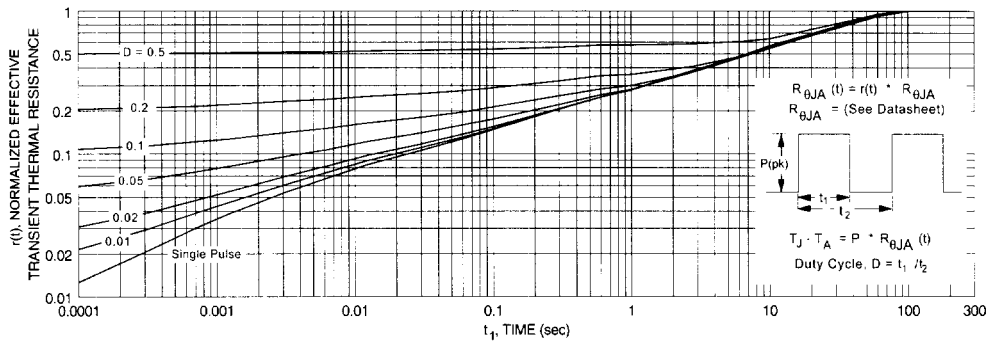

Figure 16. TO-92, 2N7000 Transient Thermal Response Curve.

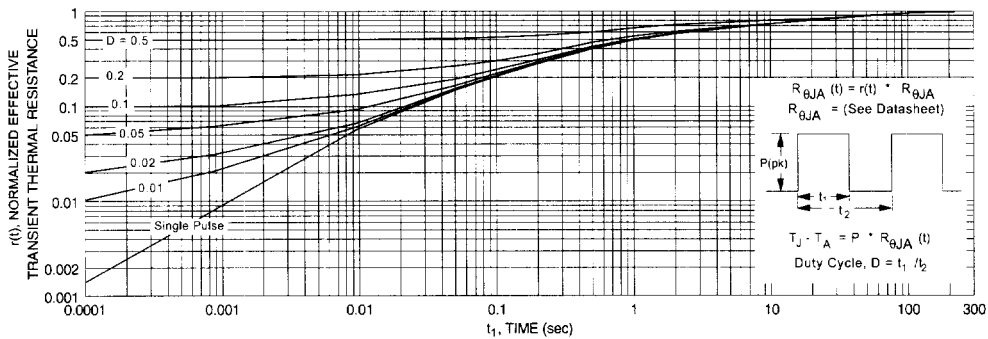

Figure 17. SOT-23, 2N7002 / NDS7002A Transient Thermal Response Curve.