

## LM138/LM338 5-Amp Adjustable Regulators

### General Description

The LM138 series of adjustable 3-terminal positive voltage regulators is capable of supplying in excess of 5A over a 1.2V to 32V output range. They are exceptionally easy to use and require only 2 resistors to set the output voltage. Careful circuit design has resulted in outstanding load and line regulation—comparable to many commercial power supplies. The LM138 family is supplied in a standard 3-lead transistor package.

A unique feature of the LM138 family is time-dependent current limiting. The current limit circuitry allows peak currents of up to 12A to be drawn from the regulator for short periods of time. This allows the LM138 to be used with heavy transient loads and speeds start-up under full-load conditions. Under sustained loading conditions, the current limit decreases to a safe value protecting the regulator. Also included on the chip are thermal overload protection and safe area protection for the power transistor. Overload protection remains functional even if the adjustment pin is accidentally disconnected.

Normally, no capacitors are needed unless the device is situated more than 6 inches from the input filter capacitors in which case an input bypass is needed. An output capacitor can be added to improve transient response, while bypassing the adjustment pin will increase the regulator's ripple rejection.

Besides replacing fixed regulators or discrete designs, the LM138 is useful in a wide variety of other applications. Since the regulator is "floating" and sees only the input-to-output differential voltage, supplies of several hundred volts can be regulated as long as the maximum input to output differential is not exceeded, i.e., do not short-circuit output to ground. The part numbers in the LM138 series which have a K suffix are packaged in a standard Steel TO-3 package, while those with a T suffix are packaged in a TO-220 plastic package. The LM138 is rated for  $-55^{\circ}\text{C} \leq T_J \leq +150^{\circ}\text{C}$ , and the LM338 is rated for  $0^{\circ}\text{C} \leq T_J \leq +125^{\circ}\text{C}$ .

### Features

- Guaranteed 7A peak output current
- Guaranteed 5A output current
- Adjustable output down to 1.2V
- Guaranteed thermal regulation
- Current limit constant with temperature
- P+ Product Enhancement tested
- Output is short-circuit protected

### Applications

- Adjustable power supplies
- Constant current regulators
- Battery chargers

### Connection Diagrams (See Physical Dimension section for further information)

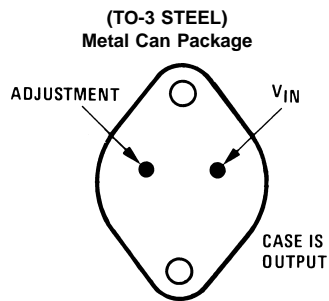

**Bottom View**  
Order Number LM138K STEEL or LM338K STEEL  
See NS Package Number K02A

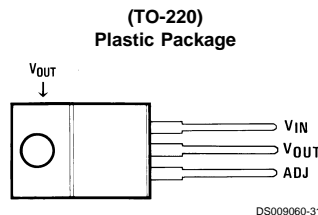

**Front View**  
Order Number LM338T  
See NS Package Number T03B

### Absolute Maximum Ratings (Note 1)

If Military/Aerospace specified devices are required, please contact the National Semiconductor Sales Office/Distributors for availability and specifications.

(Note 4)

Power Dissipation	Internally limited
Input/Output Voltage Differential	+40V, -0.3V
Storage Temperature	-65°C to +150°C

Lead Temperature		
Metal Package (Soldering, 10 seconds)		300°C
Plastic Package (Soldering, 4 seconds)		260°C
ESD Tolerance		TBD

### Operating Temperature Range

LM138	-55°C ≤ T <sub>J</sub> ≤ +150°C
LM338	0°C ≤ T <sub>J</sub> ≤ +125°C

### Electrical Characteristics

Specifications with standard type face are for T<sub>J</sub> = 25°C, and those with **boldface type** apply over full Operating Temperature Range. Unless otherwise specified, V<sub>IN</sub> - V<sub>OUT</sub> = 5V; and I<sub>OUT</sub> = 10 mA. (Note 2)

Symbol	Parameter	Conditions	LM138			Units
			Min	Typ	Max	
V <sub>REF</sub>	Reference Voltage	3V ≤ (V <sub>IN</sub> - V <sub>OUT</sub> ) ≤ 35V, 10 mA ≤ I <sub>OUT</sub> ≤ 5A, P ≤ 50W	<b>1.19</b>	<b>1.24</b>	<b>1.29</b>	V
V <sub>RLINE</sub>	Line Regulation	3V ≤ (V <sub>IN</sub> - V <sub>OUT</sub> ) ≤ 35V (Note 3)		0.005	0.01	%/V
				<b>0.02</b>	<b>0.04</b>	%/V
V <sub>RLOAD</sub>	Load Regulation	10 mA ≤ I <sub>OUT</sub> ≤ 5A (Note 3)		0.1	0.3	%
				<b>0.3</b>	<b>0.6</b>	%
	Thermal Regulation	20 ms Pulse		0.002	0.01	%/W
I <sub>ADJ</sub>	Adjustment Pin Current			<b>45</b>	<b>100</b>	μA
ΔI <sub>ADJ</sub>	Adjustment Pin Current Change	10 mA ≤ I <sub>OUT</sub> ≤ 5A, 3V ≤ (V <sub>IN</sub> - V <sub>OUT</sub> ) ≤ 35V		<b>0.2</b>	<b>5</b>	μA
ΔV <sub>R/T</sub>	Temperature Stability	T <sub>MIN</sub> ≤ T <sub>J</sub> ≤ T <sub>MAX</sub>		<b>1</b>		%
I <sub>LOAD(Min)</sub>	Minimum Load Current	V <sub>IN</sub> - V <sub>OUT</sub> = 35V		<b>3.5</b>	<b>5</b>	mA
I <sub>CL</sub>	Current Limit	V <sub>IN</sub> - V <sub>OUT</sub> ≤ 10V				
		DC	<b>5</b>	<b>8</b>		A
		0.5 ms Peak	<b>7</b>	<b>12</b>		A
		V <sub>IN</sub> - V <sub>OUT</sub> = 30V		1	1	A
V <sub>N</sub>	RMS Output Noise, % of V <sub>OUT</sub>	10 Hz ≤ f ≤ 10 kHz		0.003		%
$\frac{\Delta V_R}{\Delta V_{IN}}$	Ripple Rejection Ratio	V <sub>OUT</sub> = 10V, f = 120 Hz, C <sub>ADJ</sub> = 0 μF		<b>60</b>		dB
		V <sub>OUT</sub> = 10V, f = 120 Hz, C <sub>ADJ</sub> = 10 μF	<b>60</b>	<b>75</b>		dB
	Long-Term Stability	T <sub>J</sub> = 125°C, 1000 Hrs		0.3	1	%
θ <sub>JC</sub>	Thermal Resistance, Junction to Case	K Package			1	°C/W
θ <sub>JA</sub>	Thermal Resistance, Junction to Ambient (No Heat Sink)	K Package		35		°C/W

### Electrical Characteristics

Symbol	Parameter	Conditions	LM338			Units
			Min	Typ	Max	
V <sub>REF</sub>	Reference Voltage	3V ≤ (V <sub>IN</sub> - V <sub>OUT</sub> ) ≤ 35V, 10 mA ≤ I <sub>OUT</sub> ≤ 5A, P ≤ 50W	<b>1.19</b>	<b>1.24</b>	<b>1.29</b>	V
V <sub>RLINE</sub>	Line Regulation	3V ≤ (V <sub>IN</sub> - V <sub>OUT</sub> ) ≤ 35V (Note 3)		0.005	0.03	%/V
				<b>0.02</b>	<b>0.06</b>	%/V
V <sub>RLOAD</sub>	Load Regulation	10 mA ≤ I <sub>OUT</sub> ≤ 5A (Note 3)		0.1	0.5	%
				<b>0.3</b>	<b>1</b>	%
	Thermal Regulation	20 ms Pulse		0.002	0.02	%/W
I <sub>ADJ</sub>	Adjustment Pin Current			<b>45</b>	<b>100</b>	μA
ΔI <sub>ADJ</sub>	Adjustment Pin Current Change	10 mA ≤ I <sub>OUT</sub> ≤ 5A, 3V ≤ (V <sub>IN</sub> - V <sub>OUT</sub> ) ≤ 35V		<b>0.2</b>	<b>5</b>	μA

## Electrical Characteristics (Continued)

Symbol	Parameter	Conditions	LM338			Units
			Min	Typ	Max	
$\Delta V_{R/T}$	Temperature Stability	$T_{MIN} \leq T_J \leq T_{MAX}$		1		%
$I_{LOAD(Min)}$	Minimum Load Current	$V_{IN} - V_{OUT} = 35V$		3.5	10	mA
$I_{CL}$	Current Limit	$V_{IN} - V_{OUT} \leq 10V$				
		DC	5	8		A
		0.5 ms Peak	7	12		A
		$V_{IN} - V_{OUT} = 30V$			1	A
$V_N$	RMS Output Noise, % of $V_{OUT}$	$10 \text{ Hz} \leq f \leq 10 \text{ kHz}$		0.003		%
$\frac{\Delta V_R}{\Delta V_{IN}}$	Ripple Rejection Ratio	$V_{OUT} = 10V, f = 120 \text{ Hz}, C_{ADJ} = 0 \mu F$		60		dB
		$V_{OUT} = 10V, f = 120 \text{ Hz}, C_{ADJ} = 10 \mu F$	60	75		dB
	Long-Term Stability	$T_J = 125^\circ C, 1000 \text{ hrs}$		0.3	1	%
$\theta_{JC}$	Thermal Resistance Junction to Case	K Package			1	$^\circ C/W$
		T Package			4	$^\circ C/W$
$\theta_{JA}$	Thermal Resistance, Junction to Ambient (No Heat Sink)	K Package		35		$^\circ C/W$
		T Package		50		$^\circ C/W$

**Note 1:** Absolute Maximum Ratings indicate limits beyond which damage to the device may occur. Operating Ratings indicate conditions for which the device is intended to be functional, but do not guarantee specific performance limits. For guaranteed specifications and test conditions, see the Electrical Characteristics.

**Note 2:** These specifications are applicable for power dissipations up to 50W for the TO-3 (K) package and 25W for the TO-220 (T) package. Power dissipation is guaranteed at these values up to 15V input-output differential. Above 15V differential, power dissipation will be limited by internal protection circuitry. All limits (i.e., the numbers in the Min. and Max. columns) are guaranteed to National's AOQL (Average Outgoing Quality Level).

**Note 3:** Regulation is measured at a constant junction temperature, using pulse testing with a low duty cycle. Changes in output voltage due to heating effects are covered under the specifications for thermal regulation.

**Note 4:** Refer to RETS138K drawing for military specifications of LM138K.

## Typical Performance Characteristics

Current Limit

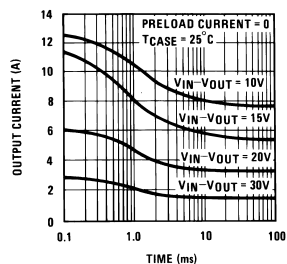

Current Limit

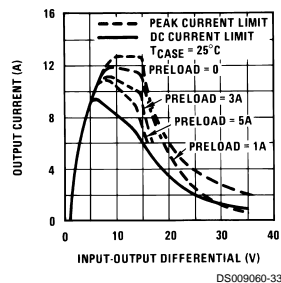

Current Limit

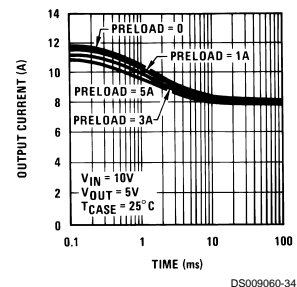

Load Regulation

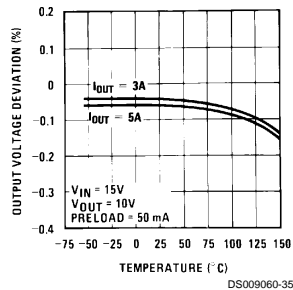

Dropout Voltage

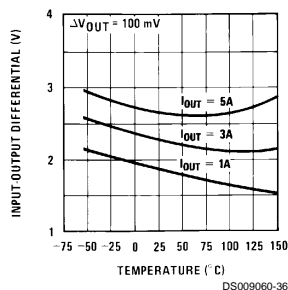

Adjustment  
Current

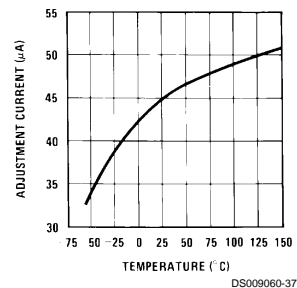

**Physical Dimensions** inches (millimeters) unless otherwise noted

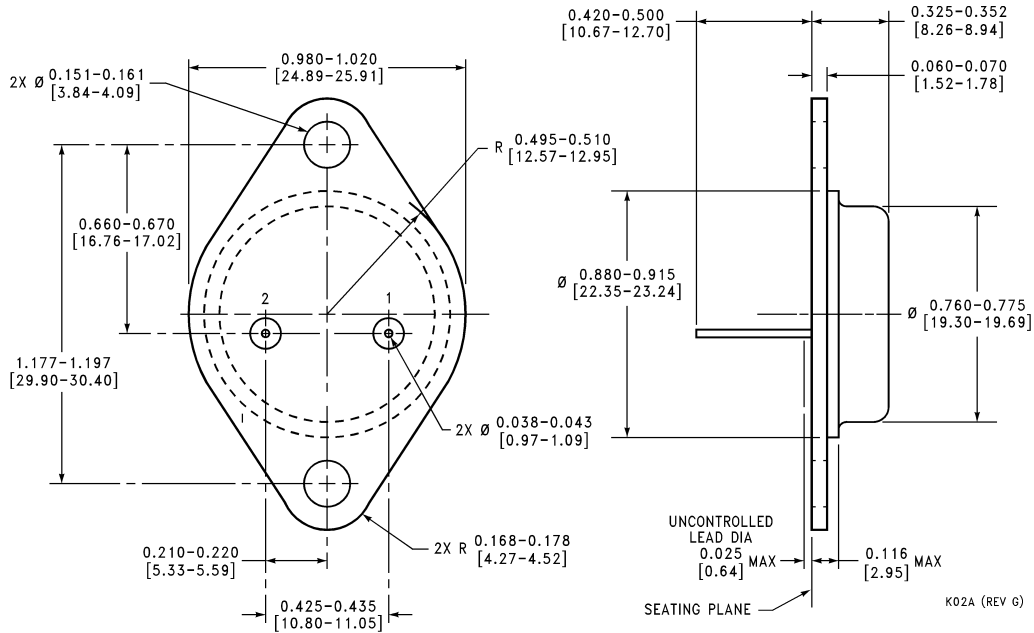

**2 Lead TO-3 Metal Can Package (K)**  
**Order Number LM138K or LM338K STEEL**  
**NS Package Number K02A**

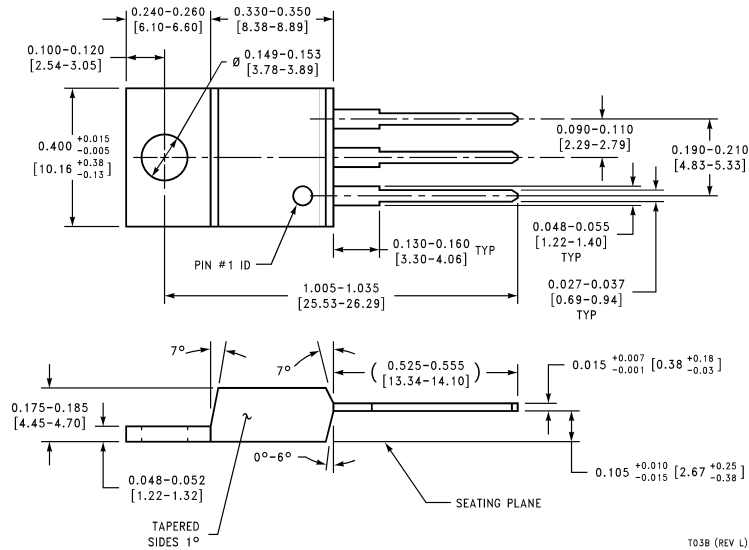

**3 Lead Molded TO-220 (T)**  
**Order Number LM338T**  
**NS Package Number T03B**