

# OPIA500B, OPIA4N35, OPIA4N33 OPIA2110, OPIA2210, OPIA5010, OPIA6010 SMD and SOP Packages



## Features:

- 3,750 or 5,000 Vrms electrical isolation
- Choice of a Single and Dual LED
- Phototransistor or Photo Darlington Sensor
- Low-cost plastic Dual-In-Line (DIP) package

## Agency Approvals:

- UL Certification No: E58730
- VDE No: 40026624,40026625

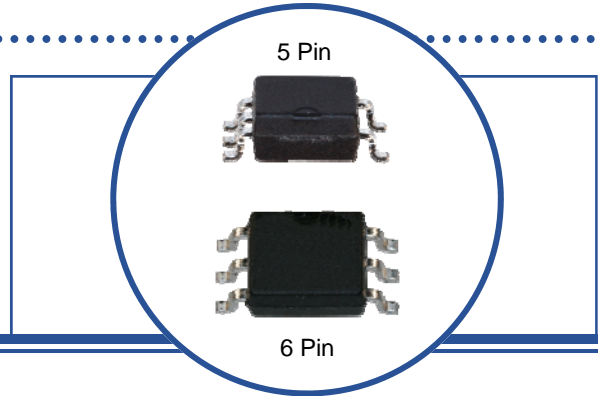

## Description:

The OPIA series optocouplers are designed for applications that use an analog output (Phototransistor or Photo Darlington) in a dual-in-line package. A wide selection of configurations are available. With typical isolation voltage of 3,750 or 5,000 Volts(RMS), these product meet typical power system isolation requirements.

Theory of operation: The LED transmitter is used to illuminate the Photosensor providing electrical isolation between two power systems while maintaining the ability to transmit information from one power system to the other. In many applications, analog signal levels may be required to be transmitted between two power systems while maintaining isolation between the power systems up to 5,000 Volts(RMS). A variety of LED and photosensor configurations are available depending on the system requirements.

The ratio Current Transfer Ratio (CTR) is determined using the output current and input current for analog photosensors. CTR ratios can range from as low as 5 to over 9,000 depending on the device.

$$CTR = \frac{\text{Photosensor - Current}}{\text{LED - Current}} = \frac{20mA}{10mA} * 100 = 200$$

All SMD product is shipped in tape and reel with "TR" identified on the end of the part number.  
Example: OPI4N35ATRE is a 6-Pin SMD shipped in tape and reel (TR).

## Applications:

- High voltage isolation
- PCBoard power system isolation
- Industrial equipment power isolation
- Medical equipment power isolation
- Office equipment



RoHS

OPTEK reserves the right to make changes at any time in order to improve design and to supply the best product possible.

# OPIA500B, OPIA4N35, OPIA4N33 OPIA2110, OPIA2210, OPIA5010, OPIA6010 SMD and SOP Packages



## Package Outline Dimensions and Schematics: Top-View

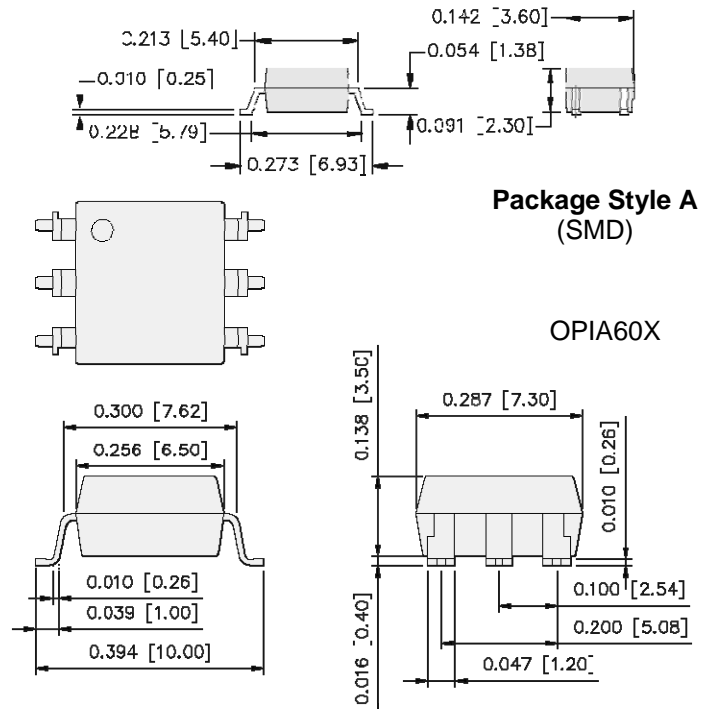
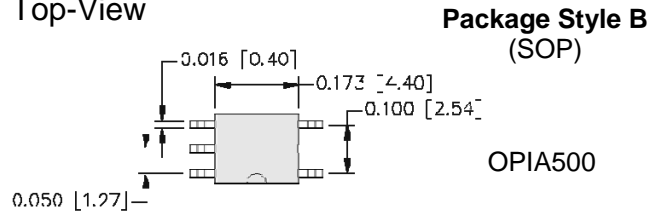
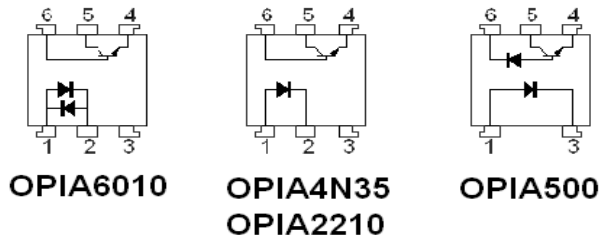
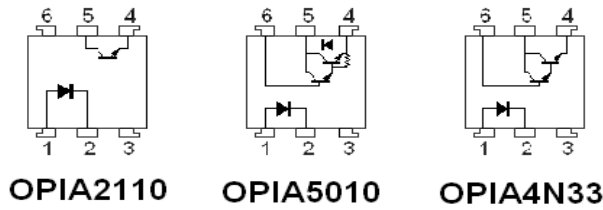

Part Number	Pin #					
	1	2	3	4	5	6
OPIA500	A		K	E	C	B
OPIA4N35	A	K		E	C	B
OPIA5010	A	K		E	C	B
OPIA4N33	A	K		E	C	B
OPIA2210	A	K		E	C	B
OPIA6010	A-K	K-A		E	C	B
OPIA2110	A	K		E	C	

Symbol	Definition	Symbol	Definition	Symbol	Definition	Symbol	Definition	Symbol	Definition
A	Anode	B	Base	C	Collector	E	Emitter	K	Cathode

## Analog Output Devices Ordering Information

Part Number	Isolation Voltage Max. (Vrms)	CTR Min/Typ/Max	Typ. Tr / Tf (µs) R <sub>L</sub> = 100 ohms	Package	Configuration
OPIA500B	3,750	19 / - / 50	LH-HL 0.8 / 0.8 (1.9K)	5-Pin SOP	AK—KCE
OPIA4N35A	5,000	60 / - / 600	5 / 4	6-Pin SMD	A K—B C E
OPIA5010A	5,000	600 / - / 9,000	60 / 50	6-Pin SMD	A K—B C E (Dar)
OPIA4N33A	5,000	500 / 4,000 / -	5 / 60	6-Pin SMD	A K—B C E (Dar)
OPIA2210A	5,000	50 / - / 600	2 / 3	6-Pin SMD	A K—B C E
OPIA6010A	5,000	50 / - / 600	2 / 3	6-Pin SMD	A K, K A—B C E
OPIA2110A	5,000	40 / - / 400	4 / 3	6-Pin SMD	A K—C E

Configuration: Definition of Terms  
LED Identification—Sensor Identification

LED	A = Anode	K = Cathode	
Sensor	B = Base	C = Collector	E = Emitter

(Dar) = Photo Darlington

Packaging	Part Number Suffix: TU = Ship in Tubes    TR = Tape and Reel	Example: OPI4N35ATRE
-----------	--	----------------------

OPTEK reserves the right to make changes at any time in order to improve design and to supply the best product possible.

**OPIA500B, OPIA4N35, OPIA4N33**  
**OPIA2110, OPIA2210, OPIA5010, OPIA6010**  
**SMD and SOP Packages**



**Absolute Maximum Ratings** ( $T_A = 25^\circ\text{C}$  unless otherwise noted)

Storage Temperature	-55° C to +125° C
Operating Temperature OPIA4N35, OPIA5010, OPIA4N33 OPIA500 OPIA2210, OPIA6010, OPIA2110	-30° C to +100° C -55° C to +85° C -55° C to +125° C
Isolation voltage (1 minute) OPIA6XX Series OPIA500	5,000 Vrms 3,750 Vrms
Total Package Power Dissipation OPIA6XX Series OPIA500	200 mW 100 mW
Lead Soldering Temperature (1/16" (1.6 mm) from case for 5 seconds with soldering iron)	260° C

**Input Diode**

Continuous Forward Current OPIA6XX Series OPIA500	50 mA 25 mA
Peak Forward current (1 $\mu\text{s}$ pulse width, 300 pps) OPIA6XX Series OPIA500	1 A 200 mA
Reverse Voltage OPIA6XX Series OPIA500	6 V 5 V
Power Dissipation OPIA6XX Series OPIA500	70 mW 45 mW

**Output Phototransistor**

<b>Collector-Emitter Voltage</b> OPIA4N35, OPIA6010, OPIA2110 OPIA2210 OPIA5010 OPIA4N33	60 V 350 V 300 V 30 V
<b>Emitter-Collector Voltage</b> OPIA4N35, OPIA2110 OPIA2210, OPIA6010 OPIA5010, OPIA4N33	6 V 7 V -
<b>Collector Current</b> OPIA4N35, OPIA2210, OPIA6010, OPIA2110 OPIA5010, OPIA4N33	50 mA 150 mA
<b>Power Dissipation</b> OPIA500 OPIA4N35, OPIA2110 OPIA5010, OPIA4N33, OPIA2210, OPIA6010	100 mW 150 mW 200 mW

OPTEK reserves the right to make changes at any time in order to improve design and to supply the best product possible.

**OPIA500B, OPIA4N35, OPIA4N33**  
**OPIA2110, OPIA2210, OPIA5010, OPIA6010**  
**SMD and SOP Packages**



**Electrical Characteristics: (OPIA500B)**

	Parameter	Symbol	Conditions	MIN.	TYP.	MAX.	Unit
Input	Forward voltage	V <sub>F</sub>	I <sub>F</sub> =16mA	• •	1.7	1.95	V
	Reverse current	I <sub>R</sub>	V <sub>R</sub> =5V	• •	• •	10	uA
	Terminal capacitance	C <sub>t</sub>	V=0, f=1MHZ	• •	60	250	pF
Output	High level output current (1)	I <sub>OH</sub> (1)	I <sub>F</sub> =0, V <sub>CC</sub> =5.5V, V <sub>O</sub> =5.5V	-	3	500	nA
	High level output current (2)	I <sub>OH</sub> (2)	I <sub>F</sub> =0, V <sub>CC</sub> =15V, V <sub>O</sub> =15V	-	-	1.0	uA
	High level output current (3) (*6)	I <sub>OH</sub> (3)		-	-	50	uA
	High level supply current (1)	I <sub>CCH</sub> (1)	I <sub>F</sub> =0, V <sub>CC</sub> =15V, V <sub>O</sub> =Open	-	0.02	1.0	uA
	High level supply current (2) (*6)	I <sub>CCH</sub> (2)		-	-	2.0	uA
	Low level supply current	I <sub>CCL</sub>	I <sub>F</sub> =16mA, V <sub>CC</sub> =15V, V <sub>O</sub> =Open	-	120	-	uA
	Low level supply voltage	V <sub>L</sub>	I <sub>F</sub> =16mA, V <sub>CC</sub> =4.5V, I <sub>O</sub> =2.4mA	• •	-	0.4	V
Transfer characteristics	Current transfer ratio (1)	CTR(1)	I <sub>F</sub> =16mA, V <sub>CC</sub> =4.5V, V <sub>O</sub> =0.4V, RL=1.9K ohm	19	• •	50	%
	Current transfer ratio (2) (*6)	CTR(2)	RL=1.9K ohm	15	• •	-	%
	Isolation resistance	R <sub>ISO</sub>	DC=500V, 40 to 60%RH	5x10 <sup>10</sup>	1x10 <sup>11</sup>	-	ohm
	Floating capacitance	C <sub>f</sub>	V=0, f=1MHZ	• •	0.6	1.0	pF
	"High-->Low" propagation delay time	t <sub>PHL</sub>	I <sub>F</sub> =16mA, V <sub>CC</sub> =5V, RL=1.9K ohm	• •	0.2	0.8	us
	"High-->Low" propagation delay time	t <sub>PLH</sub>		-	0.4	0.8	us
	Instantaneous common mode rejection voltage (High level output)	CMH	I <sub>F</sub> =0, V <sub>CC</sub> =5V, V <sub>CM</sub> =1.0KV(p-p), RL=1.9K ohm	15	30	-	KV/us
	Instantaneous common mode rejection voltage (High level output)	CML	I <sub>F</sub> =16mA, V <sub>CC</sub> =5V, V <sub>CM</sub> =1.0KV(p-p), RL=1.9K ohm	-15	-30	-	KV/us

OPTEK reserves the right to make changes at any time in order to improve design and to supply the best product possible.

**OPIA500B, OPIA4N35, OPIA4N33  
OPIA2110, OPIA2210, OPIA5010, OPIA6010  
SMD and SOP Packages**



**Electrical Characteristics (OPIA6XX Series)**

SYMBOL	PARAMETER	MIN	TYP	MAX	UNITS	TEST CONDITIONS
--------	-----------	-----	-----	-----	-------	-----------------

**Input Diode**

$V_f$	Forward Voltage OPIA4N35, OPIA5010, OPIA4N33, OPIA604, OPIA2110 OPIA2210	- 1.0	1.2 1.2	1.4 1.3	V	$I_F = 20 \text{ mA}$ $I_F = 10 \text{ mA}$
$V_{FM}$	Peek Forward Voltage OPIA4N35, OPIA5010, OPIA4N33, OPIA604 OPIA2210, OPIA2110	- -	- -	3.5 3.0	V	$I_{FM} = 500 \text{ mA}$
$I_r$	Reverse Current OPIA4N35, OPIA5010, OPIA4N33, OPIA604, OPIA2110 OPIA2210	- -	- -	10 10	$\mu\text{A}$	$V_R = 4 \text{ V}$ $V_R = 5 \text{ V}$
$C_t$	Terminal Capacitance OPIA4N35, OPIA5010, OPIA4N33, OPIA604, OPIA2110 OPIA2210	- -	30 30	- -	pf	$V = 0.0 \text{ V}, f = 1\text{K Hz}$ $V = 0.0 \text{ V}, f = 1\text{M Hz}$

**Output Phototransistor—OPIA4N35D, OPIA2210D, OPIA6010D, OPIA2110D**

$I_{CEO}$	Collector dark Current OPIA4N35, OPIA6010, OPIA2110 OPIA2210	- -	- 10	100 200	nA	$I_F = 0 \text{ mA}, V_{CE} = 20 \text{ V}$ $I_F = 0 \text{ mA}, V_{CE} = 300 \text{ V}$
$V_{CEO}$	Collector-emitter Saturation Voltage OPIA4N35, OPIA6010, OPIA2110 OPIA2210	- -	0.1 -	0.3 0.4	V	$I_F = 20 \text{ mA}, I_C = 1 \text{ mA}$ $I_F = 8 \text{ mA}, I_C = 2.4 \text{ mA}$
$f_c$	Cutt-Off frequency	-	80	-	K Hz	$V_{CC} = 5 \text{ V}, I_C = 2 \text{ mA}, R_L = 100 \Omega$
$t_r$	Rise Time OPIA4N35, OPIA6010 OPIA2210 OPIA2110	- - -	5 2 4	20 - 20	$\mu\text{s}$	$V_{CC} = 5 \text{ V}, I_C = 2 \text{ mA}, R_L = 100 \Omega$ $V_{CC} = 10 \text{ V}, I_C = 2 \text{ mA}, R_L = 100 \Omega$ $V_{CC} = 2 \text{ V}, I_C = 2 \text{ mA}, R_L = 100 \Omega$
$t_f$	Fall Time OPIA4N35, OPIA6010 OPIA2210 OPIA2110	- - -	4 3 3	20 - 20	$\mu\text{s}$	$V_{CC} = 5 \text{ V}, I_C = 2 \text{ mA}, R_L = 100 \Omega$ $V_{CC} = 10 \text{ V}, I_C = 2 \text{ mA}, R_L = 100 \Omega$ $V_{CC} = 2 \text{ V}, I_C = 2 \text{ mA}, R_L = 100 \Omega$

Continued on Next Page

OPTEK reserves the right to make changes at any time in order to improve design and to supply the best product possible.

**OPIA500B, OPIA4N35, OPIA4N33**  
**OPIA2110, OPIA2210, OPIA5010, OPIA6010**  
**SMD and SOP Packages**



**Electrical Characteristics (OPIA6XX Series) - Continued from Previous Page**

SYMBOL	PARAMETER	MIN	TYP	MAX	UNITS	TEST CONDITIONS
--------	-----------	-----	-----	-----	-------	-----------------

**Output PhotoDarlington—OPIA5010D, OPIA4N332D**

I <sub>CEO</sub>	Collector dark Current OPIA5010 OPIA4N33	- -	- -	1.0 0.1	μA	I <sub>F</sub> = 0 mA, V <sub>CE</sub> = 200 V I <sub>F</sub> = 0 mA, V <sub>CE</sub> = 10 V
V <sub>CEO</sub>	Collector-emitter Saturation Voltage OPIA5010 OPIA4N33	- -	- -	1.5 1.0	V	I <sub>F</sub> = 20 mA, I <sub>C</sub> = 5 mA I <sub>F</sub> = 8 mA, I <sub>C</sub> = 2 mA
f <sub>c</sub>	Cutt-Off frequency OPIA5010, OPIA4N33	-	7.0	-	K Hz	V <sub>CC</sub> = 5 V, I <sub>C</sub> = 2 mA, R <sub>L</sub> = 100 Ω
t <sub>r</sub>	Rise Time OPIA5010 OPIA4N33	- -	60 5	300 40	μs	V <sub>CC</sub> = 2 V, I <sub>C</sub> = 20 mA, R <sub>L</sub> = 100 Ω V <sub>CC</sub> = 10 V, I <sub>C</sub> = 50 mA, R <sub>L</sub> = 100 Ω
t <sub>f</sub>	Fall Time OPIA5010 OPIA4N33	- -	50 60	250 100	μs	V <sub>CC</sub> = 2 V, I <sub>C</sub> = 20 mA, R <sub>L</sub> = 100 Ω V <sub>CC</sub> = 10 V, I <sub>C</sub> = 50 mA, R <sub>L</sub> = 100 Ω

**Coupled Characteristics Phototransistor/Photodarlington**

CTR	Current Transfer Ratio OPIA4N35 OPIA5010 OPIA4N33 OPIA2210 OPIA6010 OPIA2110	60 600 500 50 60 40	- - 4,000 - - -	600 9,000 - 600 600 400	%	I <sub>F</sub> = 2 mA, V <sub>CE</sub> = 5.0 V I <sub>F</sub> = 2 mA, V <sub>CE</sub> = 5.0 V I <sub>F</sub> = 10 mA, V <sub>CE</sub> = 10.0 V I <sub>F</sub> = 5 mA, V <sub>CE</sub> = 5.0 V I <sub>F</sub> = 1 mA, V <sub>CE</sub> = 5.0 V I <sub>F</sub> = 10 mA, V <sub>CE</sub> = 5.0 V
C <sub>f</sub>	Floating Capacitance	-	0.6	1.0	pF	V = 0.0 V, f = 1M Hz
R <sub>ISO</sub>	Isolation resistance	5X10 <sup>10</sup>	10 <sup>11</sup>	-	ohm	DC500V

OPTEK reserves the right to make changes at any time in order to improve design and to supply the best product possible.

OPIA4N35

Fig.1 Current Transfer Ratio vs. Forward Current

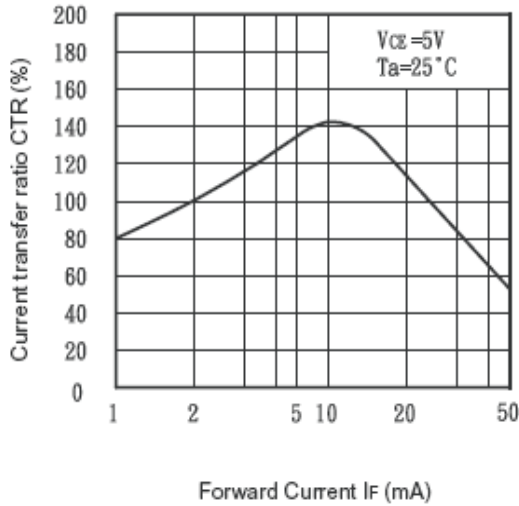

Fig.2 Collector Power Dissipation vs. Ambient Temperature

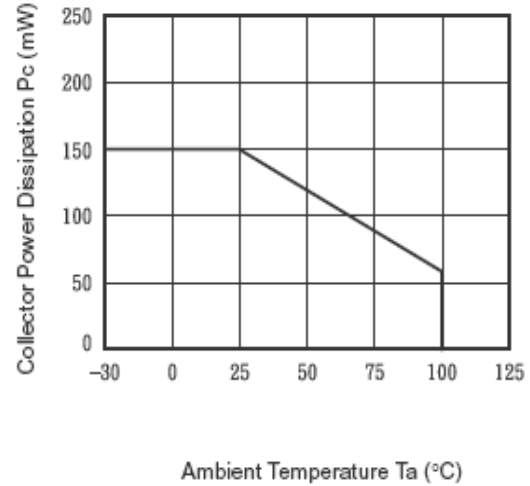

Fig.3 Collector Dark Current vs. Ambient Temperature

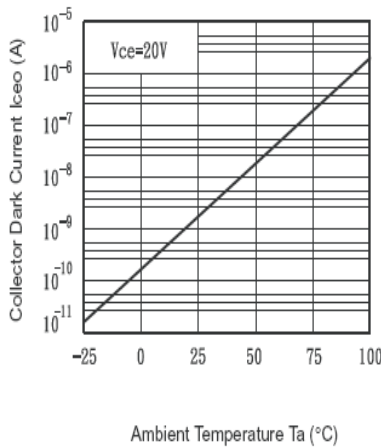

Fig.4 Forward Current vs. Ambient Temperature

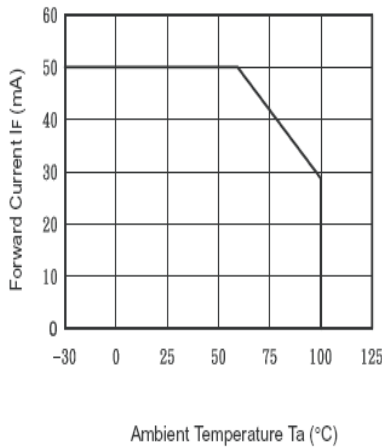
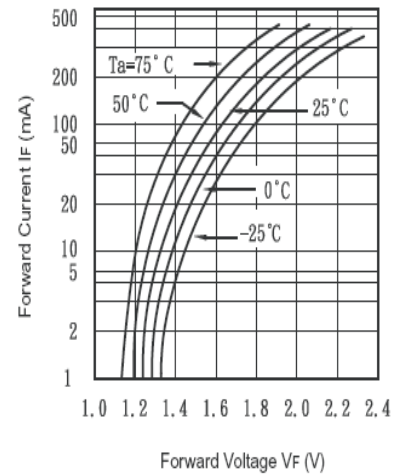

Fig.5 Forward Current vs. Forward Voltage



OPTEK reserves the right to make changes at any time in order to improve design and to supply the best product possible.

OPIA4N35

Fig.6 Collector Current vs. Collector-emitter Voltage

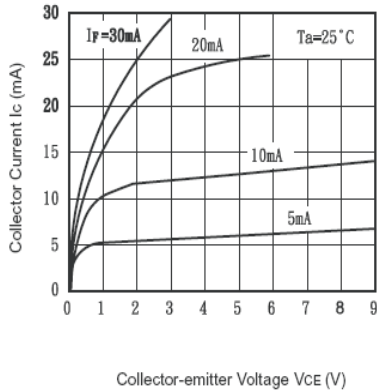

Fig.7 Relative Current Transfer Ratio vs. Ambient Temperature

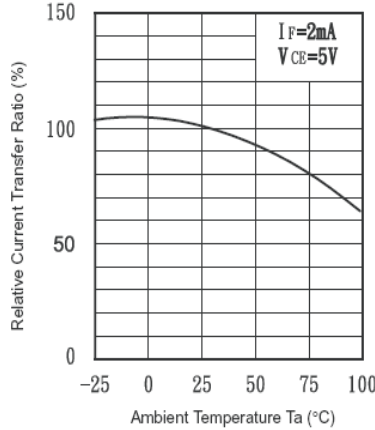

Fig.8 Collector-emitter Saturation Voltage vs. Ambient Temperature

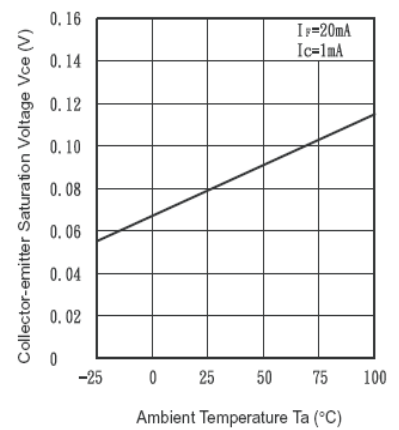

Fig.9 Collector-emitter Saturation Voltage vs. Forward Current

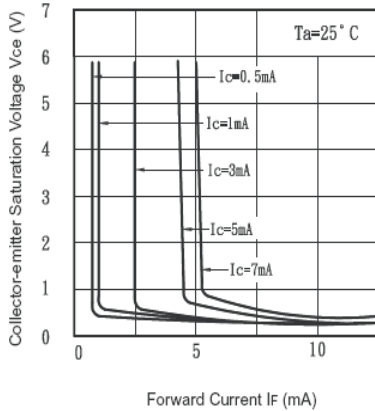

Fig.10 Response Time vs. Load Resistance

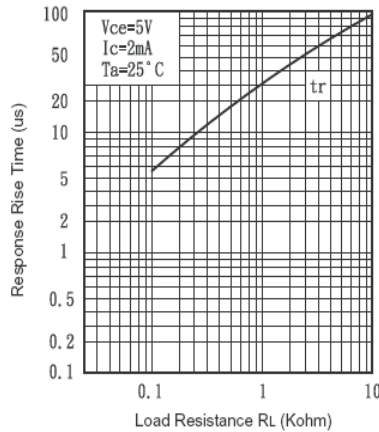
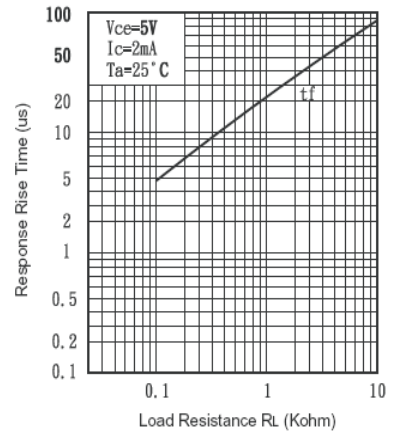

Fig.11 Response Time vs. Load Resistance



OPTEK reserves the right to make changes at any time in order to improve design and to supply the best product possible.



OPIA5010

Fig. 4 Forward Current vs. Ambient Temperature

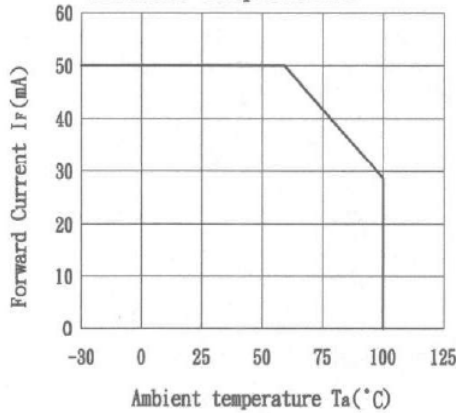

Fig. 5 Forward Current vs. Forward Voltage

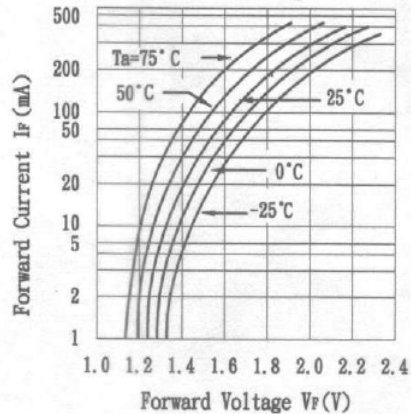

Fig. 2 Collector Power Dissipation vs. Ambient Temperature

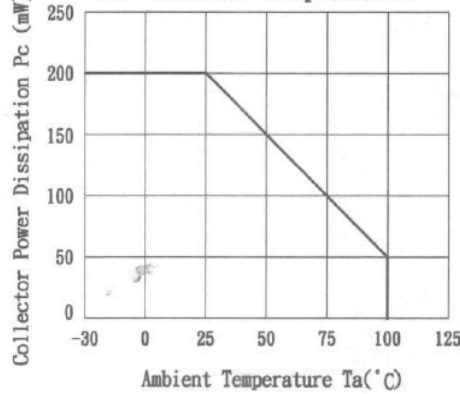

Fig. 3 Collector Dark Current vs. Ambient Temperature

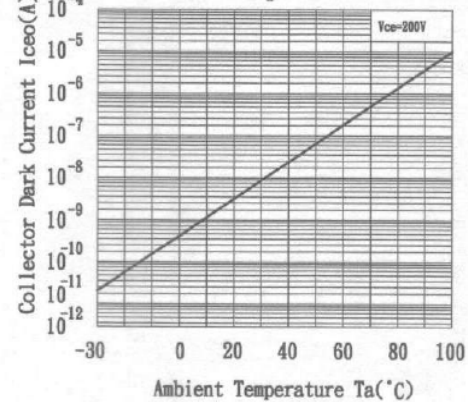

Fig. 6 Collector Current vs. Collector-emitter Voltage

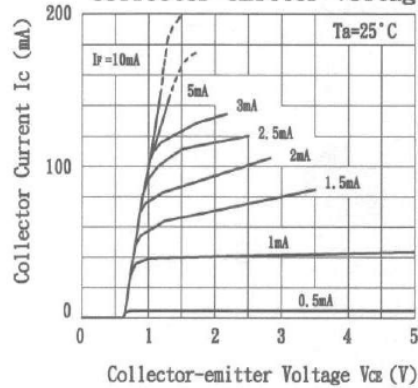
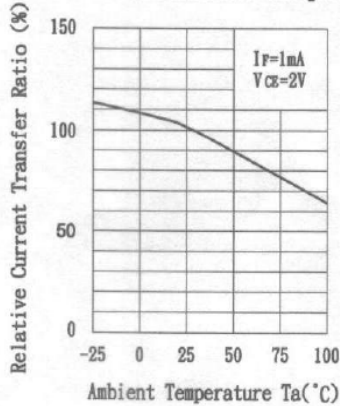

Fig. 7 Relative Current Transfer Ratio vs. Ambient Temperature



OPTEK reserves the right to make changes at any time in order to improve design and to supply the best product possible.

OPIA5010

Fig. 1 Current Transfer Ratio vs. Forward Current

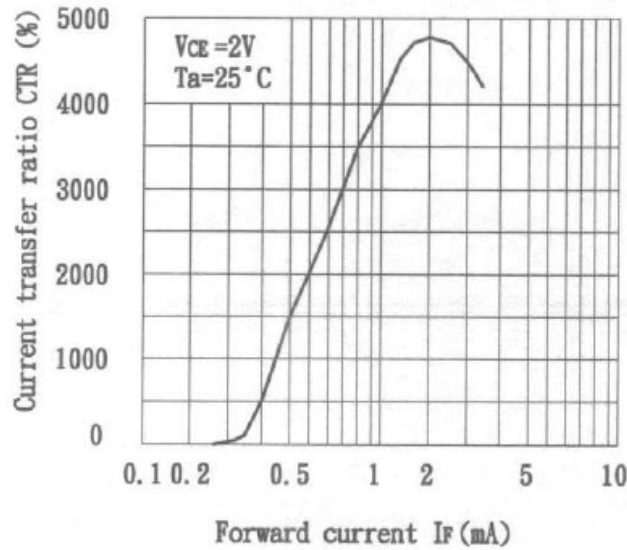

Fig. 8 Collector-emitter Saturation Voltage vs. Forward Current

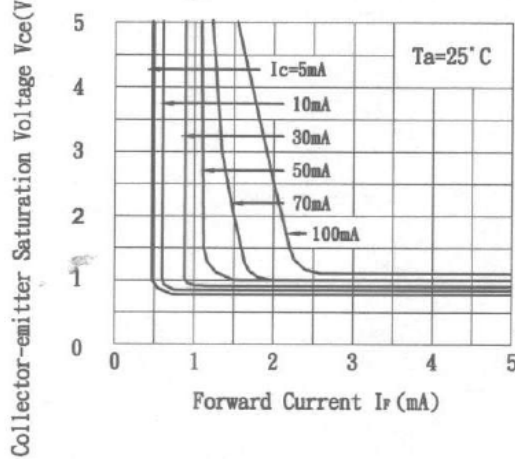
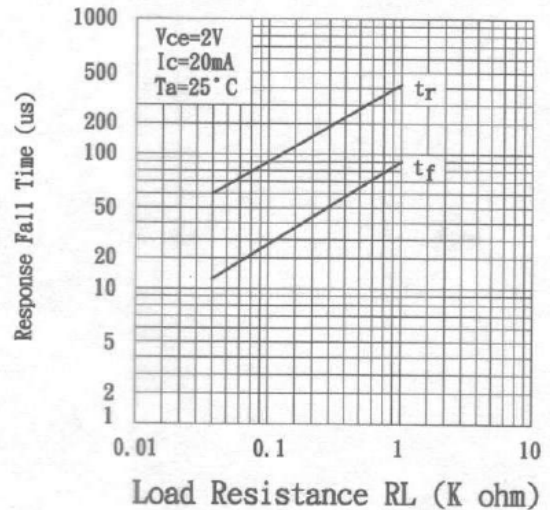

Fig. 9 Response Time vs. Load Resistance



OPTEK reserves the right to make changes at any time in order to improve design and to supply the best product possible.

OPIA4N33

Fig. 1 Forward Current vs. Ambient Temperature

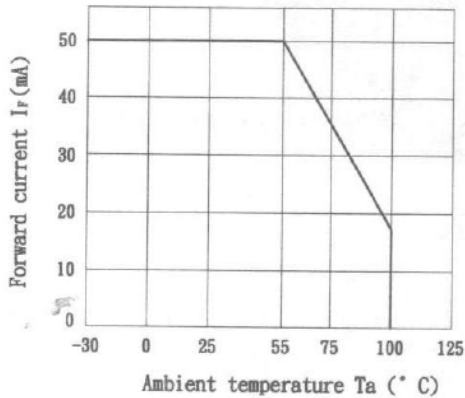

Fig. 2 Collector Power Dissipation vs. Ambient Temperature

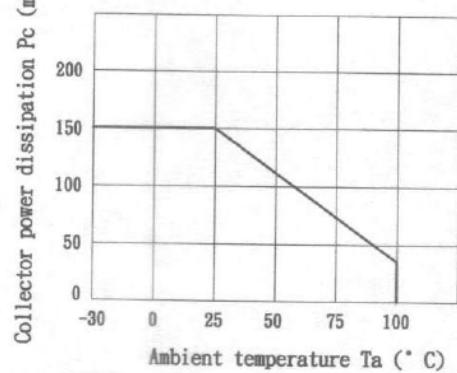

Fig. 3 Peak Forward Current vs. Duty Ratio

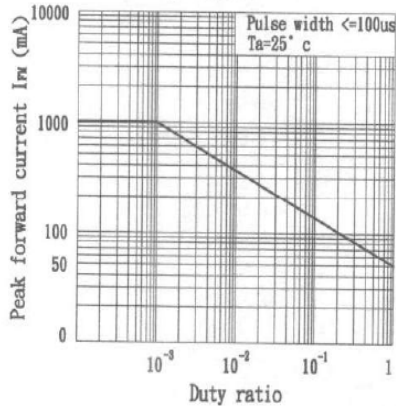

Fig. 4 Forward Current vs. Forward Voltage

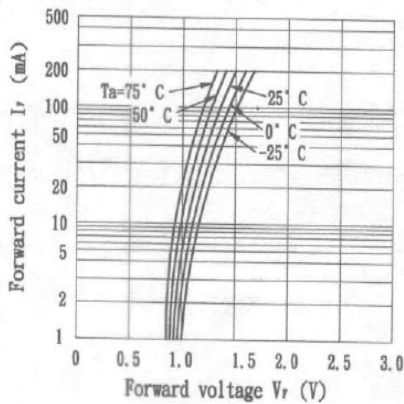

Fig. 5 Current Transfer Ratio vs. Forward Current

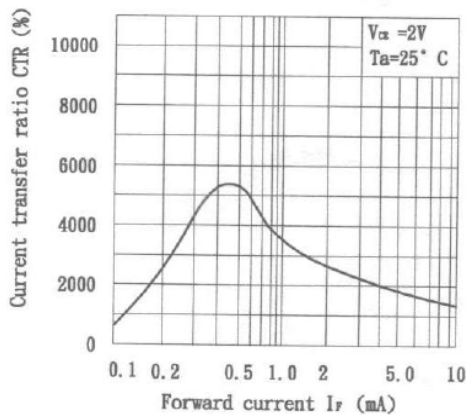
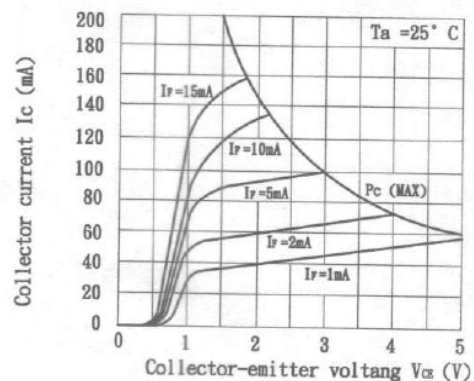

Fig. 6 Collector Current vs. Collector-emitter Voltage



OPTEK reserves the right to make changes at any time in order to improve design and to supply the best product possible.

OPIA4N33

Fig.11 Collector-emitter Saturation Voltage vs. Forward current

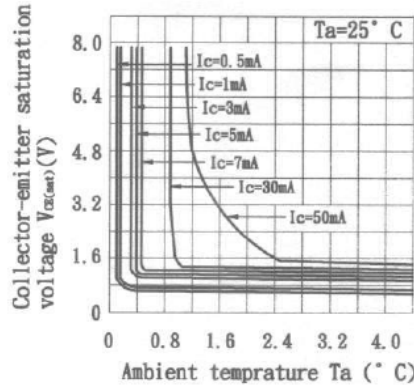

Fig.7 Relative Current Transfer Ratio vs. Ambient Temperature

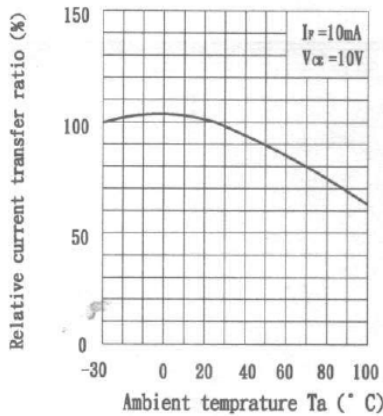

Fig.8 Collector-emitter Saturation Voltage vs. Ambient Temperature

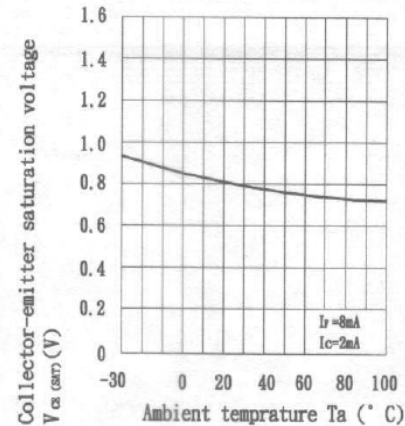

Fig.9 Collector Dark Current vs. Ambient Temperature

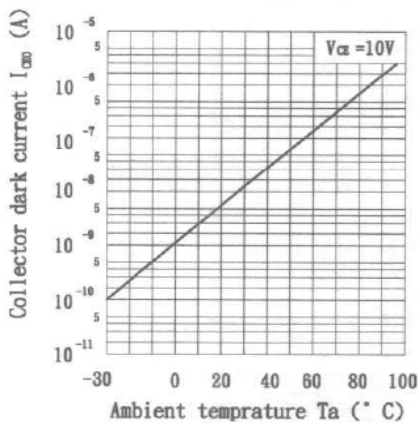
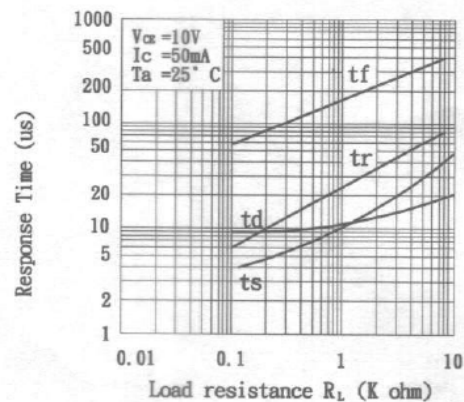

Fig.10 Response Time vs. Load Resistance



OPTEK reserves the right to make changes at any time in order to improve design and to supply the best product possible.

OPIA2210

Fig.1 Current Transfer Ratio vs. Forward Current

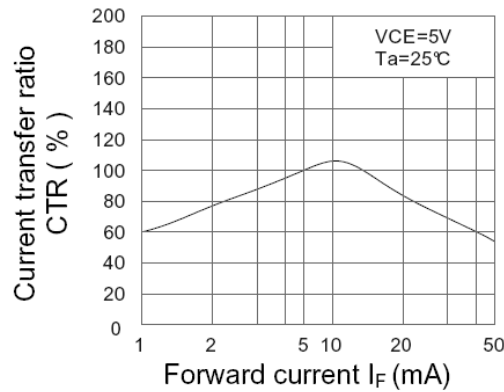

Fig.2 Collector Power Dissipation vs. Ambient Temperature

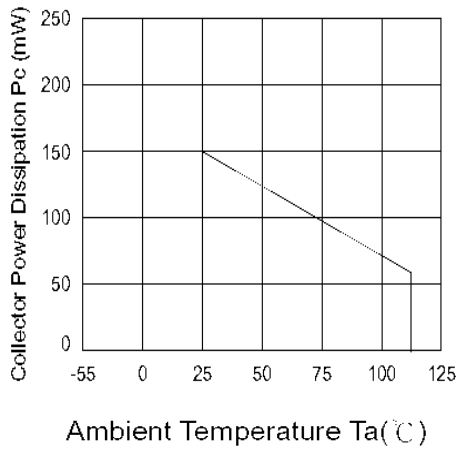

Fig.3 Collector Dark Current vs. Ambient Temperature

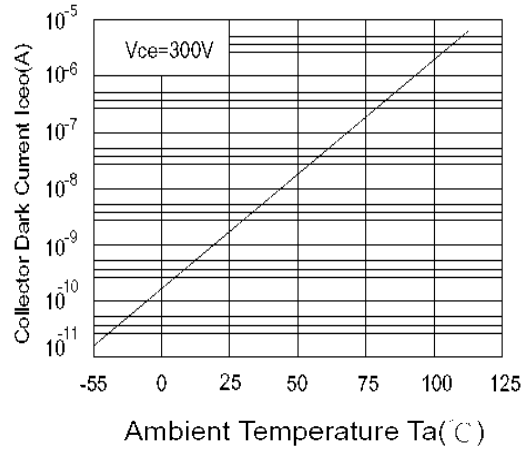

Fig.4 Forward Current vs. Ambient Temperature

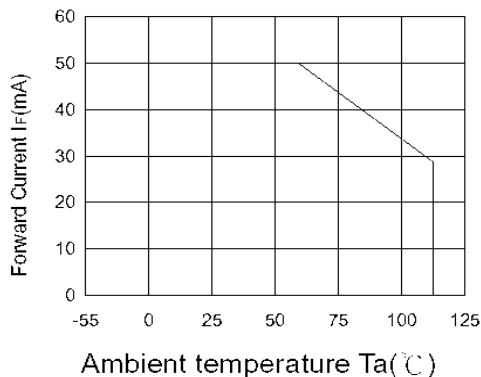
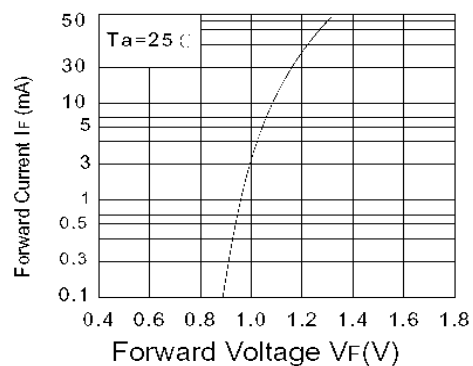

Fig.5 Forward Current vs. Forward Voltage



OPTEK reserves the right to make changes at any time in order to improve design and to supply the best product possible.

OPIA2210

Fig.6 Collector Current vs. Collector-emitter Voltage

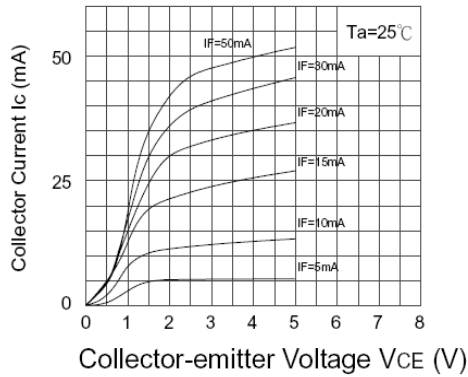

Fig.7 Relative Current Transfer Ratio vs. Ambient Temperature

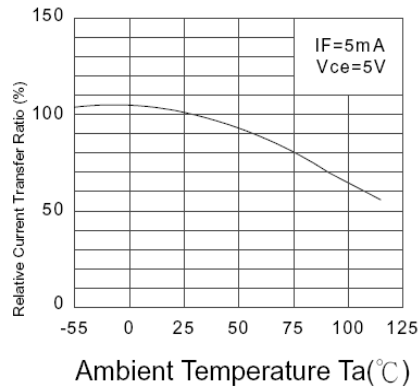

Fig.8 Collector-emitter Saturation Voltage vs. Ambient Temperature

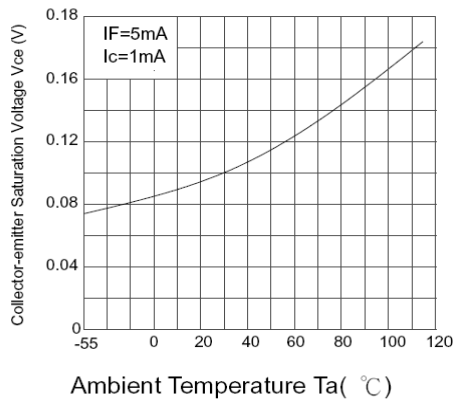

Fig.9 Collector-emitter Saturation Voltage vs. Forward Current

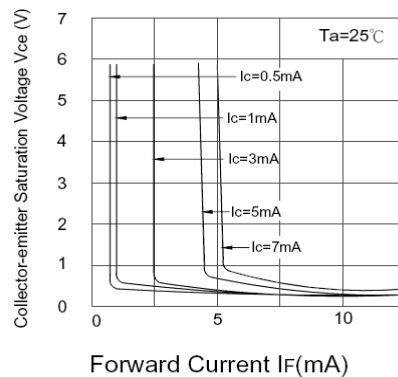

Fig.10 Response Time vs. Load Resistance

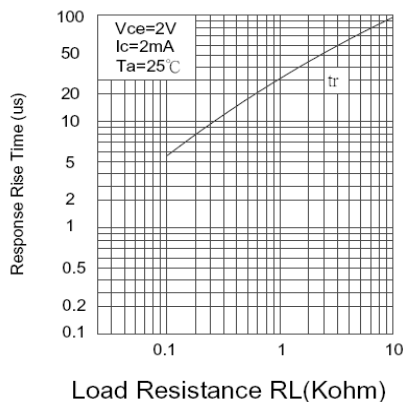
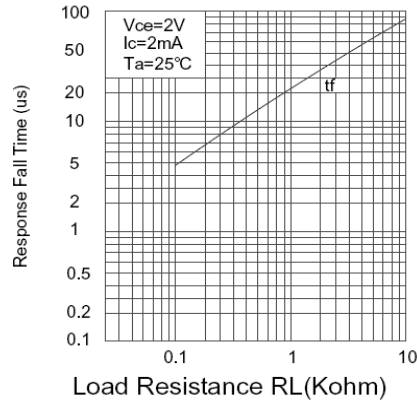

Fig.11 Response Time vs. Load Resistance



OPTEK reserves the right to make changes at any time in order to improve design and to supply the best product possible.

OPIA6010

Fig.1 Current Transfer Ratio vs. Forward Current

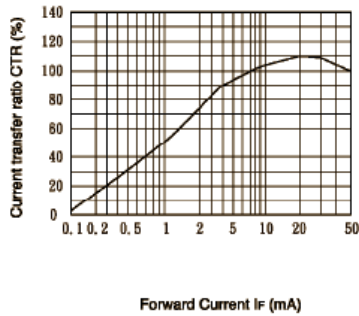

Fig.2 Collector Power Dissipation vs. Ambient Temperature

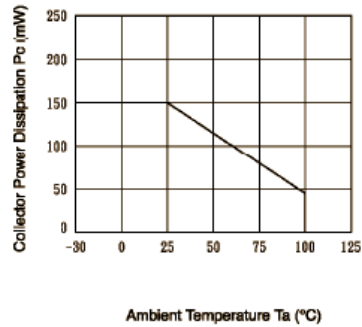

Fig.3 Collector Dark Current vs. Ambient Temperature

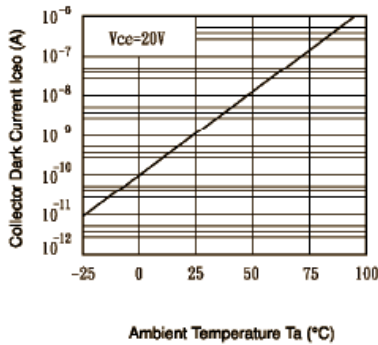

Fig.4 Forward Current vs. Ambient Temperature

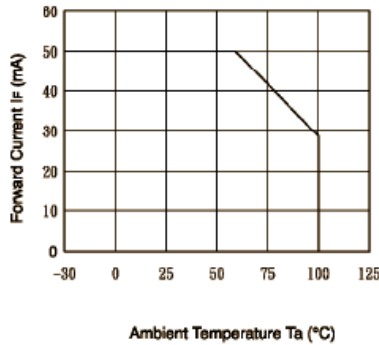

Fig.5 Forward Current vs. Forward Voltage

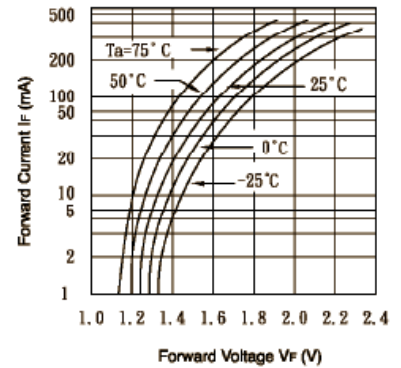

Fig.6 Collector Current vs. Collector-emitter Voltage

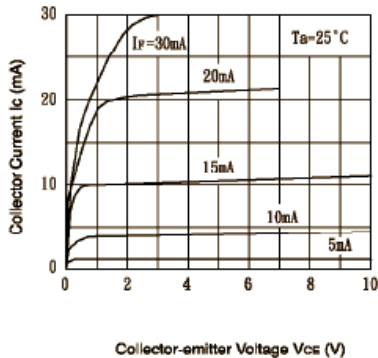

Fig.7 Relative Current Transfer Ratio vs. Ambient Temperature

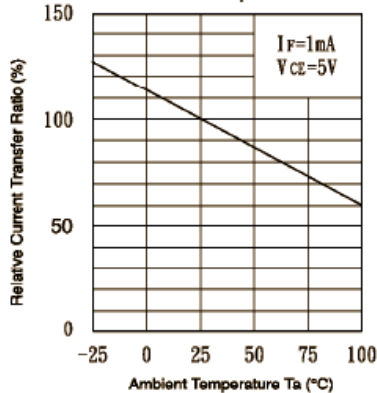
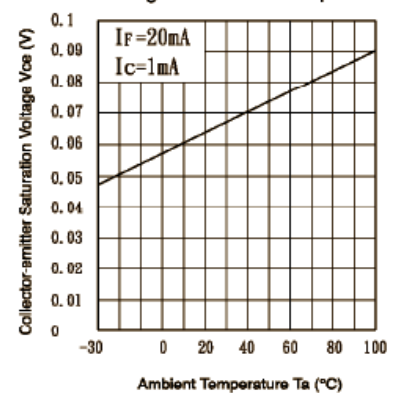

Fig.8 Collector-emitter Saturation Voltage vs. Ambient Temperature



OPTeK reserves the right to make changes at any time in order to improve design and to supply the best product possible.

OPIA6010

Fig.9 Collector-emitter Saturation Voltage vs. Forward Current

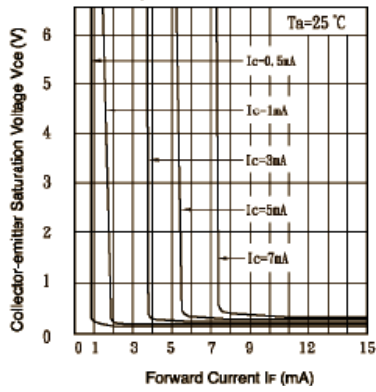

Fig.10 Response Time vs. Load Resistance

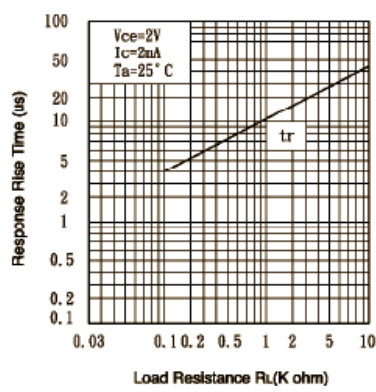
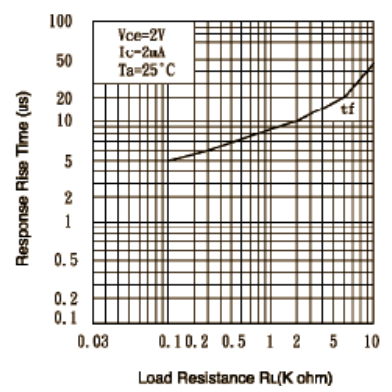

Fig.11 Response Time vs. Load Resistance



OPTEK reserves the right to make changes at any time in order to improve design and to supply the best product possible.



OPIA2110

Fig.1 Current Transfer Ratio vs. Forward Current

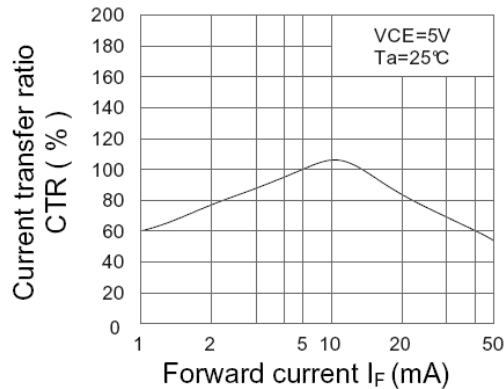

Fig.2 Collector Power Dissipation vs. Ambient Temperature

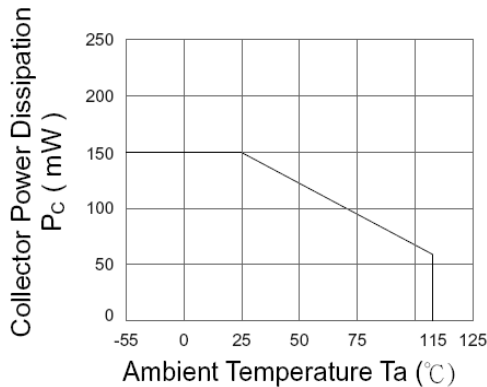

Fig.3 Collector Dark Current vs. Ambient Temperature

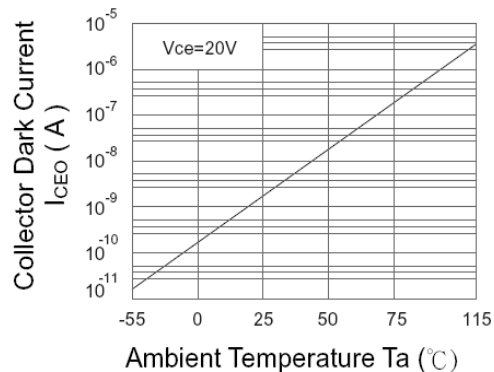

Fig.4 Forward Current vs. Ambient Temperature

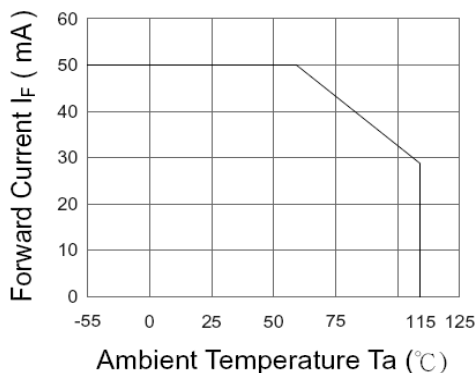
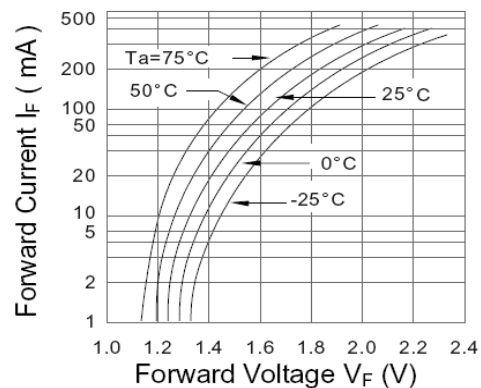

Fig.5 Forward Current vs. Forward Voltage



OPTEK reserves the right to make changes at any time in order to improve design and to supply the best product possible.

OPIA2110

Fig.6 Collector Current vs. Collector-Emitter Voltage

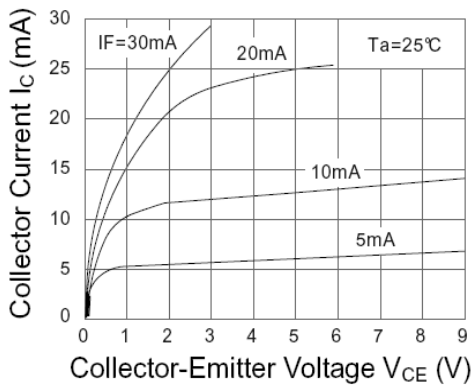

Fig.7 Relative Current Transfer Ratio vs. Ambient Temperature

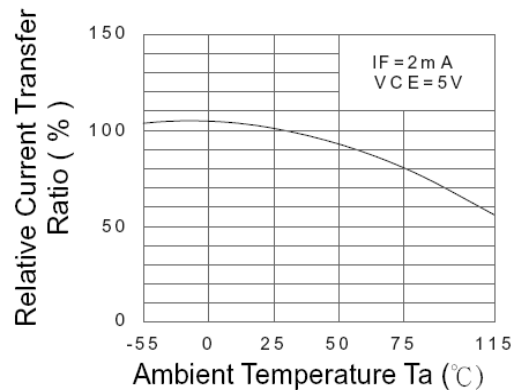

Fig.8 Collector-Emitter Saturation Voltage vs. Ambient Temperature

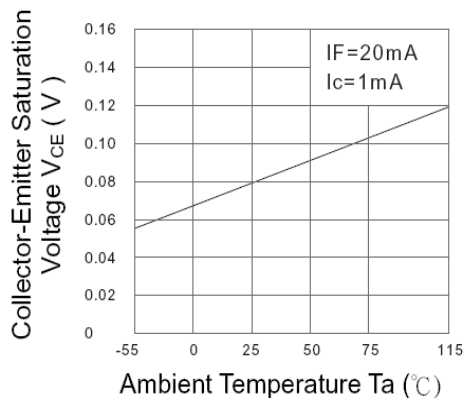

Fig.9 Collector-Emitter Saturation Voltage vs. Forward Current

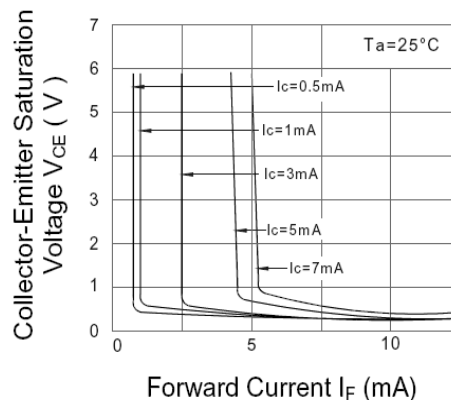

Fig.10 Response Time vs. Load Resistance

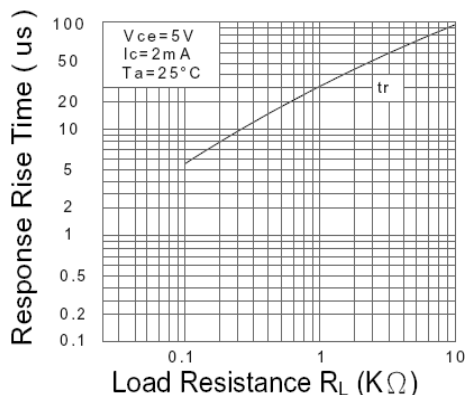
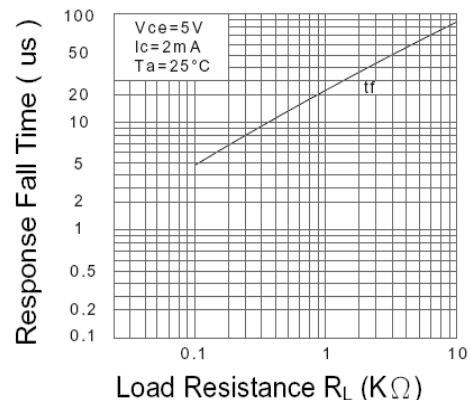

Fig.11 Response Time vs. Load Resistance



OPTEK reserves the right to make changes at any time in order to improve design and to supply the best product possible.

**OPIA500B, OPIA4N35, OPIA4N33  
OPIA2110, OPIA2210, OPIA5010, OPIA6010  
SMD and SOP Packages**



**Quality / Reliability Requirements**

Parameter	Failure Criteria	Conditions
HTRB D I <sub>C(OFF)</sub>	± 10%	11 samples after 500Hrs
	0 Fail	@ VCE = 5.0VDC, Ta = 70°C
HTFB D I <sub>C(ON)</sub>	± 10%	50 samples after 96Hrs
	0 Fail	@ Max P <sub>D</sub> , Ta = 25°C
MTTF @ 90% confidence	150,000 Min.	@ 25°C, 25mADC
Moisture Sensitivity Level	MSL 1	per JDEC std J-STD-020B
Lead Solderability	0 Fail	per Method 208 of MIL-STD-202.
Glass Transition of body	125°C Min.	DSC test method
Temperature Humidity-Bias	± 20%	85°C, 85%RH, 500Hrs, 80% min I <sub>ceo</sub>
Temperature Cycle	± 20%	per Method 1010.7 of MIL-STD-883E
High Temperature Storage	± 20%	85°C, 500Hrs
Autoclave	0 Fail	T <sub>A</sub> = 121°C, Pressure = 15psi, Humidity = 100%, Time = 96Hrs

**Note:** This is to be performed when a change occurs to form, fit or function.

**Government and Industry Standard  
Compliance Requirements**

European Union’s Reduction of Hazardous Substances (RoHS) Directive 2002/95/EC

**Label Identification**

**DESCRIPTION:**

Size: 3” (7.4 cm) X 2.2” (5.5 cm)  
Lettering shall be black on white background.  
Format shall be as:

**Notes:**

1. The DATE CODE is a 4-digit code for date of manufacture where YY is the last two digits of the year, and WW is week number of manufacture.
2. The LOT I.D. is the manufacturing location lot identification where Y is the year of manufacture, NNNN is a sequential lot identifier, and DDD is the day of the year of manufacture. – or use equivalent label format.

 Carrollton, TX, USA MADE IN TAIWAN 
OPTEK P/N <u>  OPIA2110A-TR  </u> 
QTY. <u>  N/A  </u> 
DATE CODE <u>  (Y Y W W)  </u> 
LOT I.D. <u>  (Y - N N N N D D D)  </u> 

OPTEK reserves the right to make changes at any time in order to improve design and to supply the best product possible.

**OPIA500B, OPIA4N35, OPIA4N33  
OPIA2110, OPIA2210, OPIA5010, OPIA6010  
SMD and SOP Packages**



**Packaging Information:**

Optek's Optocoupler Part Numbers		Packaging Quantities		Tube		Inner			Small Carton			Medium Carton			Large Carton		
				Qty	Weight	52 x 7 x 7.5 cm		53.5 x 16 x 17.5 cm			53.5 x 30.7 x 17.5 cm			53.5 x 30.7 x 25 cm			
						Qty	Weight	Qty	Weight	Gross Weight	Qty	Weight	Gross Weight	Qty	Weight	Gross Weight	
<b>P/H and SMD</b>	<b>4-PIN</b> OPIA400D/A, OPIA410D/A - OPIA413D/A	100	44	3,000	1.40	12,000	6.0	6.5	24,000	12.0	12.5	36,000	18.0	18.5			
	<b>6-PIN</b> OPIA6XXD/A Series	65	44	1,950	1.50	7,800	6.5	7.0	15,600	12.0	12.5	23,400	18.5	19.0			
	<b>8-PIN</b> OPIA8XXD Series and OPID804D	48	44	1,440	1.44	5,760	6.0	6.5	11,520	12.0	12.5	17,290	18.0	18.5			
<b>M/F SOP</b>	<b>4-PIN and 5-PIN</b> OPIA401B - OPIA404B, OPIA414B, OPIA500B	100	24	6,000	1.60	24,000	6.5	7.0	48,000	13.0	13.5	72,000	19.5	20.0			
<b>SSOP</b>	<b>4-PIN</b> OPIA405C - OPIA409C	170	--	10,200	--												

**P/H** = Pin-Hole Packages (Referred as D = Dual-In-Line Package)

**SMD** = Standard Surface Mount Packages (Referred as A = 6.5mil SMD)

**M/F or SOP** = Mini-Flat Packages or Small Outside Packages (Referred as B = 4.40mil SMD w/ 2.54mil Lead-Spacing)

**SSOP** = Shrink SOP Packages (Referred as C = 3.60mil SMD with 1.27mil Lead-Spacing)

OPTEK reserves the right to make changes at any time in order to improve design and to supply the best product possible.

**OPIA500B, OPIA4N35, OPIA4N33  
OPIA2110, OPIA2210, OPIA5010, OPIA6010  
SMD and SOP Packages**



**Tube Packaging Specifications—SMD (TU):**

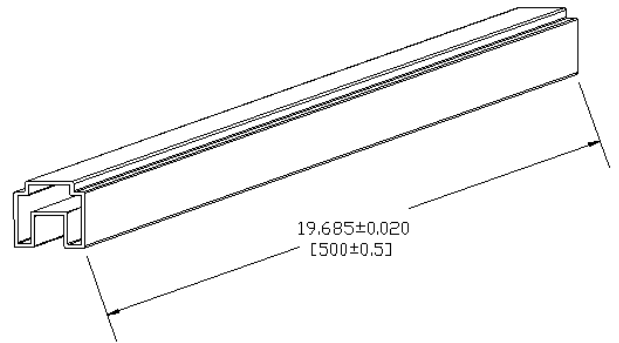
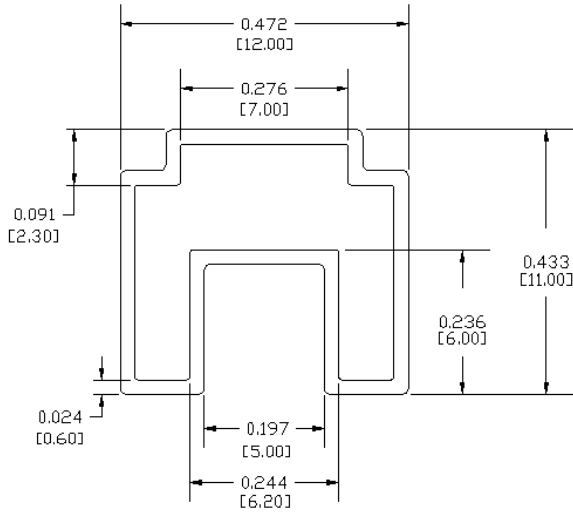

**DIMENSIONS ARE IN: INCHES [MILLIMETERS]**  
**TOLERANCE: ± 0.008 INCHES**  
[± 0.2 MILLIMETERS]

**Quantity: 6-pin: 65pcs/tube**

**Tube Packaging Specifications— SOP (Mini-flats) (TU):**

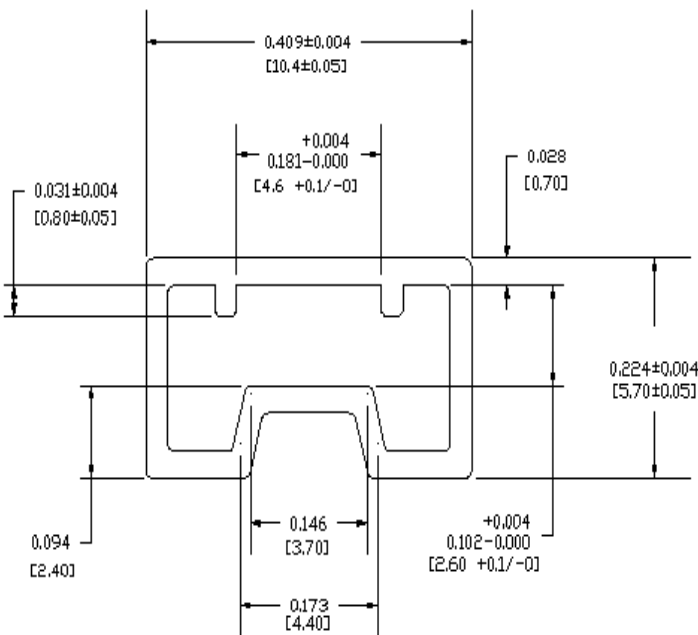

**DIMENSIONS ARE IN: INCHES [MILLIMETERS]**  
**TOLERANCE: ± 0.008 INCHES**  
[± 0.2 MILLIMETERS]

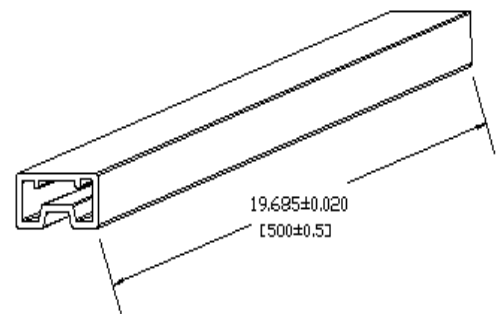

**Quantity: 5-pin: 100pcs/tube**

OPTEK reserves the right to make changes at any time in order to improve design and to supply the best product possible.

# OPIA500B, OPIA4N35, OPIA4N33 OPIA2110, OPIA2210, OPIA5010, OPIA6010 SMD and SOP Packages



## Tape and Reel Packaging Specifications—SMD —(TR):

0.157 ± 0.004  
[4.0 ± 0.1]

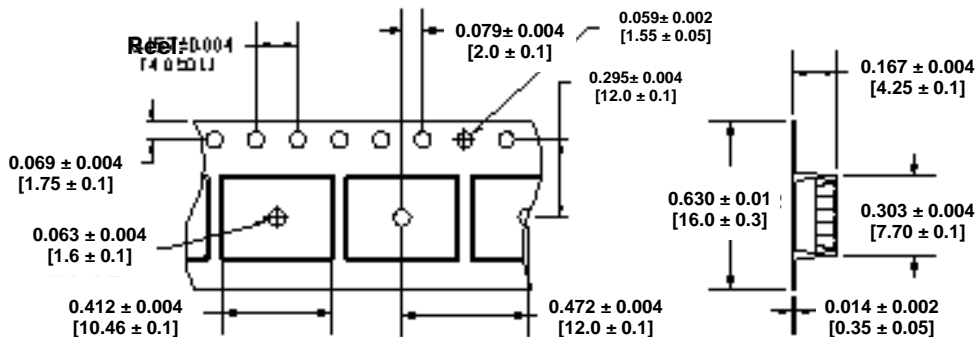

Direction:

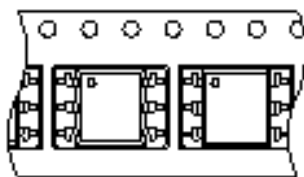

DIMENSIONS ARE IN: INCHES [MILLIMETERS]  
TOLERANCE: ± 0.008 INCHES  
[± 0.2 MILLIMETERS]

Reel:

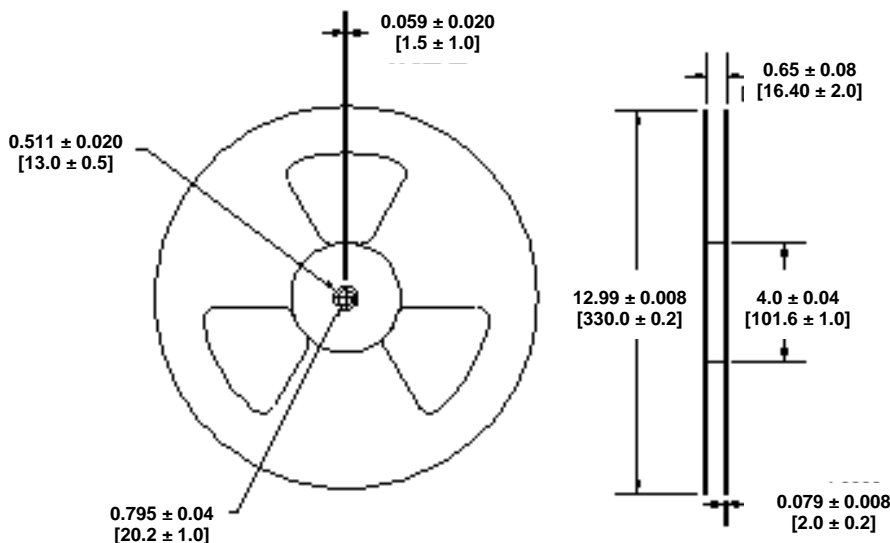

Quantity: 6-pin: 1000pcs/Reel

OPTEK reserves the right to make changes at any time in order to improve design and to supply the best product possible.

OPIA500B, OPIA4N35, OPIA4N33  
 OPIA2110, OPIA2210, OPIA5010, OPIA6010  
 SMD and SOP Packages



Tape and Reel Packaging Specifications—SOP (Mini-Flat) — (TR):

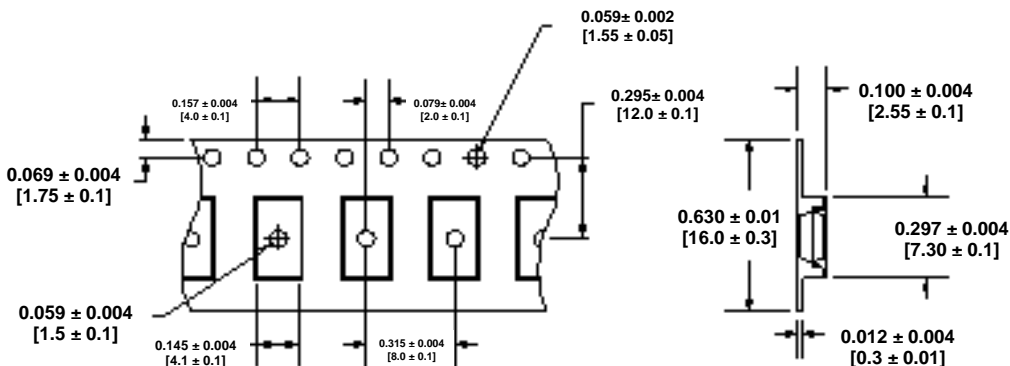

Direction:

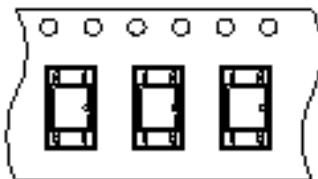

DIMENSIONS ARE IN: INCHES [MILLIMETERS]  
 TOLERANCE: ± 0.008 INCHES  
 [± 0.2 MILLIMETERS]

Reel:

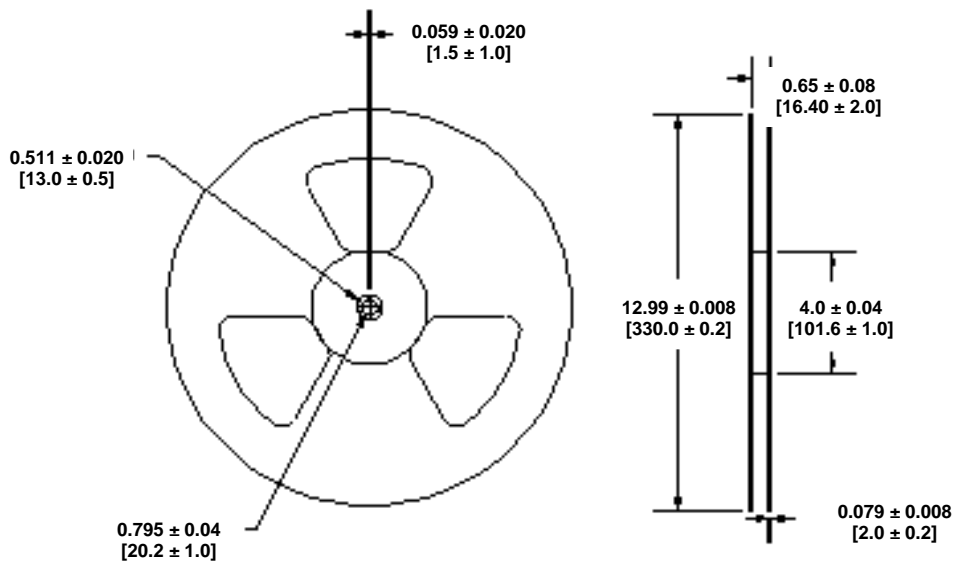

Quantity: 5-pin: 1000pcs/Reel

OPTEK reserves the right to make changes at any time in order to improve design and to supply the best product possible.