

1MSPS, 12-/10-/8-Bit A/D Converters in SOT-23 & LLP

General Description

The ADCS7476, ADCS7477, and ADCS7478 are low power, monolithic CMOS 12-, 10- and 8-bit analog-to-digital converters that operate at 1 MSPS. The ADCS7476/77/78 are drop-in replacements for Analog Devices' AD7476/77/78. Each device is based on a successive approximation register architecture with internal track-and-hold. The serial interface is compatible with several standards, such as SPI™, QSPI™, MICROWIRE™, and many common DSP serial interfaces.

The ADCS7476/77/78 uses the supply voltage as a reference, enabling the devices to operate with a full-scale input range of 0 to V_{DD} . The conversion rate is determined from the serial clock (SCLK) speed. These converters offer a shut-down mode, which can be used to trade throughput for power consumption. The ADCS7476/77/78 is operated with a single supply that can range from +2.7V to +5.25V. Normal power consumption during continuous conversion, using a +3V or +5V supply, is 2 mW or 10 mW respectively. The power down feature, which is enabled by a chip select (\overline{CS}) pin, reduces the power consumption to under 5 μ W using a +5V supply. All three converters are available in a 6-lead, SOT-23 package and in a 6-lead LLP, both of which provide an extremely small footprint for applications where space is a critical consideration. These products are designed for operation over the automotive/extended industrial temperature range of -40°C to $+125^{\circ}\text{C}$.

Features

- Variable power management
- Packaged in 6-lead, SOT-23 and LLP
- Power supply used as reference
- Single +2.7V to +5.25V supply operation
- SPI™/QSPI™/MICROWIRE™/DSP compatible

Key Specifications

- | | |
|------------------------------------|----------------------|
| ■ Resolution with no Missing Codes | 12/10/8 bits |
| ■ Conversion Rate | 1 MSPS |
| ■ DNL | +0.5, -0.3 LSB (typ) |
| ■ INL | ± 0.4 LSB (typ) |
| ■ Power Consumption | |
| — 3V Supply | 2 mW (typ) |
| — 5V Supply | 10 mW (typ) |

Applications

- Automotive Navigation
- FA/ATM Equipment
- Portable Systems
- Medical Instruments
- Mobile Communications
- Instrumentation and Control Systems

Connection Diagram

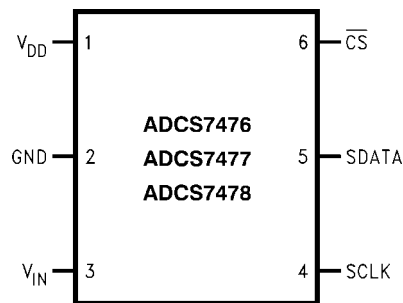

Ordering Information

Order Code	Temperature Range	Description	Top Mark
ADCS7476AIMF	-40°C to +125°C	6-Lead SOT-23 Package, 1000 Units Tape & Reel	X01A
ADCS7477AIMF	-40°C to +85°C	6-Lead SOT-23 Package, 1000 Units Tape & Reel	X02A
ADCS7478AIMF	-40°C to +85°C	6-Lead SOT-23 Package, 1000 Units Tape & Reel	X03A
ADCS7476AIMFX	-40°C to +125°C	6-Lead SOT-23 Package, 3000 Units Tape & Reel	X01A
ADCS7476AISDX	-40°C to +125°C	6-Lead LLP, 3000 Units Tape & Reel	X1A
ADCS7477AIMFX	-40°C to +85°C	6-Lead SOT-23 Package, 3000 Units Tape & Reel	X02A
ADCS7477AISDX	-40°C to +85°C	6-Lead LLP, 3000 Units Tape & Reel	X2A
ADCS7478AIMFX	-40°C to +85°C	6-Lead SOT-23 Package, 3000 Units Tape & Reel	X03A
ADCS7478AISDX	-40°C to +85°C	6-Lead LLP, 3000 Units Tape & Reel	X3A
ADCS7476AIMFE	-40°C to +85°C	6-Lead SOT-23 Package, 250 Units Tape & Reel	X01A
ADCS7477AIMFE	-40°C to +85°C	6-Lead SOT-23 Package, 250 Units Tape & Reel	X02A
ADCS7478AIMFE	-40°C to +85°C	6-Lead SOT-23 Package, 250 Units Tape & Reel	X03A

Pin Descriptions

Pin No.	Symbol	Description
ANALOG I/O		
3	V_{IN}	Analog input. This signal can range from 0V to V_{DD} .
DIGITAL I/O		
4	SCLK	Digital clock input. The range of frequencies for this input is 10 kHz to 20 MHz, with guaranteed performance at 20 MHz. This clock directly controls the conversion and readout processes.
5	SDATA	Digital data output. The output words are clocked out of this pin by the SCLK pin.
6	\overline{CS}	Chip select. A conversion process begins on the falling edge of \overline{CS} .
POWER SUPPLY		
1	V_{DD}	Positive supply pin. These pins should be connected to a quiet +2.7V to +5.25V source and bypassed to GND with 0.1 μ F and 1 μ F monolithic capacitors located within 1 cm of the power pin. The ADCS7476/77/78 uses this power supply as a reference, so it should be thoroughly bypassed.
2	GND	The ground return for the supply.

Block Diagram

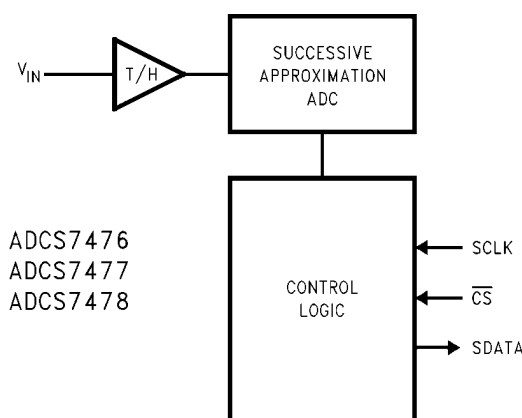

20057718

Absolute Maximum Ratings (Note 1)

If Military/Aerospace specified devices are required, please contact the National Semiconductor Sales Office/Distributors for availability and specifications.

Supply Voltage V_{DD}	-0.3V to +6.5V
Voltage on Any Analog Pin to GND	-0.3V to V_{DD} +0.3V
Voltage on Any Digital Pin to GND	-0.3V to 6.5V
Input Current at Any Pin <small>(Note 3)</small>	±10 mA
ESD Susceptibility	
Human Body Model	3500V
Machine Model	200V
Soldering Temperature, Infrared, 10 seconds	215°C
Junction Temperature	+150°C
Storage Temperature	-65°C to +150°C

Operating Ratings

Operating Temperature Range	$T_{MIN} = -40^{\circ}\text{C} \leq T_A \leq$ $T_{MAX} = +125^{\circ}\text{C}$
V_{DD} Supply Voltage	+2.7V to +5.25V
Digital Input Pins Voltage Range <small>(Note 4)</small>	+2.7V to +5.25V

Package Thermal Resistance

Package	θ_{JA}
6-Lead SOT-23	265°C / W
6-Lead LLP	78°C / W

ADCS7476/ADCS7477/ADCS7478 Specifications (Note 2)

ADCS7476 Converter Electrical Characteristics

The following specifications apply for $V_{DD} = +2.7\text{V}$ to 5.25V , $f_{SCLK} = 20\text{ MHz}$, $f_{SAMPLE} = 1\text{ MSPS}$ unless otherwise noted. **Boldface limits apply for $T_A = -40^{\circ}\text{C}$ to $+85^{\circ}\text{C}$** ; all other limits $T_A = 25^{\circ}\text{C}$, unless otherwise noted.

Symbol	Parameter	Conditions	Typical	Limits	Units
STATIC CONVERTER CHARACTERISTICS					
	Resolution with No Missing Codes	$V_{DD} = 2.7\text{V}$ to 3.6V , $-40^{\circ}\text{C} \leq T_A \leq 125^{\circ}\text{C}$		12	Bits
INL	Integral Non-Linearity	$V_{DD} = 2.7\text{V}$ to 3.6V , $-40^{\circ}\text{C} \leq T_A \leq 85^{\circ}\text{C}$	±0.4	±1	LSB (max)
		$V_{DD} = 2.7\text{V}$ to 3.6V , $T_A = 125^{\circ}\text{C}$		+1 -1.1	LSB (max) LSB (min)
DNL	Differential Non-Linearity	$V_{DD} = 2.7\text{V}$ to 3.6V , $-40^{\circ}\text{C} \leq T_A \leq 85^{\circ}\text{C}$	+0.5 -0.3	+1 -0.9	LSB (max) LSB (min)
		$V_{DD} = 2.7\text{V}$ to 3.6V , $T_A = 125^{\circ}\text{C}$		±1	LSB (max)
V_{OFF}	Offset Error	$V_{DD} = 2.7\text{V}$ to 3.6V , $-40^{\circ}\text{C} \leq T_A \leq 125^{\circ}\text{C}$	±0.1	±1.2	LSB (max)
GE	Gain Error	$V_{DD} = 2.7\text{V}$ to 3.6V , $-40^{\circ}\text{C} \leq T_A \leq 125^{\circ}\text{C}$	±0.2	±1.2	LSB (max)
DYNAMIC CONVERTER CHARACTERISTICS					
SINAD	Signal-to-Noise Plus Distortion Ratio	$f_{IN} = 100\text{ kHz}$, $-40^{\circ}\text{C} \leq T_A \leq 125^{\circ}\text{C}$	72	70	dB (min)
SNR	Signal-to-Noise Ratio	$f_{IN} = 100\text{ kHz}$, $-40^{\circ}\text{C} \leq T_A \leq 85^{\circ}\text{C}$	72.5	70.8	dB (min)
		$f_{IN} = 100\text{ kHz}$, $T_A = 125^{\circ}\text{C}$		70.6	dB (min)
THD	Total Harmonic Distortion	$f_{IN} = 100\text{ kHz}$	-80		dB
SFDR	Spurious-Free Dynamic Range	$f_{IN} = 100\text{ kHz}$	82		dB
IMD	Intermodulation Distortion, Second Order Terms	$f_a = 103.5\text{ kHz}$, $f_b = 113.5\text{ kHz}$	-78		dB
	Intermodulation Distortion, Third Order Terms	$f_a = 103.5\text{ kHz}$, $f_b = 113.5\text{ kHz}$	-78		dB
FPBW	-3 dB Full Power Bandwidth	+5V Supply	11		MHz
		+3V Supply	8		MHz

Symbol	Parameter	Conditions	Typical	Limits	Units
POWER SUPPLY CHARACTERISTICS					
V_{DD}	Supply Voltage	$-40^{\circ}\text{C} \leq T_A \leq 125^{\circ}\text{C}$		2.7 5.25	V (min) V (max)
I_{DD}	Normal Mode (Static)	$V_{DD} = +4.75\text{V to } +5.25\text{V}$, SCLK On or Off	2		mA
		$V_{DD} = +2.7\text{V to } +3.6\text{V}$, SCLK On or Off	1		mA
	Normal Mode (Operational)	$V_{DD} = +4.75\text{V to } +5.25\text{V}$, $f_{\text{SAMPLE}} = 1 \text{ MSPS}$	2.0	3.5	mA (max)
		$V_{DD} = +2.7\text{V to } +3.6\text{V}$, $f_{\text{SAMPLE}} = 1 \text{ MSPS}$	0.6	1.6	mA (max)
	Shutdown Mode	$V_{DD} = +5\text{V}$, SCLK Off	0.5		μA
$V_{DD} = +5\text{V}$, SCLK On		60		μA	
P_D	Power Consumption, Normal Mode (Operational)	$V_{DD} = +5\text{V}$, $f_{\text{SAMPLE}} = 1 \text{ MSPS}$	10	17.5	mW (max)
		$V_{DD} = +3\text{V}$, $f_{\text{SAMPLE}} = 1 \text{ MSPS}$	2	4.8	mW (max)
	Power Consumption, Shutdown Mode	$V_{DD} = +5\text{V}$, SCLK Off	2.5		μW
		$V_{DD} = +3\text{V}$, SCLK Off	1.5		μW
ANALOG INPUT CHARACTERISTICS					
V_{IN}	Input Range		0 to V_{DD}		V
I_{DCL}	DC Leakage Current			± 1	μA (max)
C_{INA}	Analog Input Capacitance		30		pF
DIGITAL INPUT CHARACTERISTICS					
V_{IH}	Input High Voltage			2.4	V (min)
V_{IL}	Input Low Voltage	$V_{DD} = +5\text{V}$		0.8	V (max)
		$V_{DD} = +3\text{V}$		0.4	V (max)
I_{IN}	Input Current	$V_{IN} = 0\text{V or } V_{DD}$	$\pm 10 \text{ nA}$	± 1	μA (max)
C_{IND}	Digital Input Capacitance		2	4	pF (max)
DIGITAL OUTPUT CHARACTERISTICS					
V_{OH}	Output High Voltage	$I_{\text{SOURCE}} = 200 \mu\text{A}$, $V_{DD} = +2.7\text{V to } +5.25\text{V}$		$V_{DD} - 0.2$	V (min)
V_{OL}	Output Low Voltage	$I_{\text{SINK}} = 200 \mu\text{A}$		0.4	V (max)
I_{OL}	TRI-STATE® Leakage Current			± 10	μA (max)
C_{OUT}	TRI-STATE Output Capacitance		2	4	pF (max)
	Output Coding		Straight (Natural) Binary		
AC ELECTRICAL CHARACTERISTICS					
f_{SCLK}	Clock Frequency	$-40^{\circ}\text{C} \leq T_A \leq 125^{\circ}\text{C}$		20	MHz (max)
DC	SCLK Duty Cycle			40	% (min)
				60	% (max)
t_{TH}	Track/Hold Acquisition Time			400	ns (max)
f_{RATE}	Throughput Rate	See Serial Interface Section		1	MSPS (max)
t_{AD}	Aperture Delay		3		ns
t_{AJ}	Aperture Jitter		30		ps

ADCS7477 Converter Electrical Characteristics

The following specifications apply for $V_{DD} = +2.7V$ to $5.25V$, $f_{SCLK} = 20$ MHz, $f_{SAMPLE} = 1$ MSPS unless otherwise noted. **Boldface limits apply for $T_A = -40^\circ C$ to $+85^\circ C$** ; all other limits $T_A = 25^\circ C$, unless otherwise noted.

Symbol	Parameter	Conditions	Typical	Limits	Units
STATIC CONVERTER CHARACTERISTICS					
	Resolution with No Missing Codes			10	Bits
INL	Integral Non-Linearity		± 0.2	± 0.7	LSB (max)
DNL	Differential Non-Linearity		+0.3 -0.2	± 0.7	LSB (max) LSB (min)
V_{OFF}	Offset Error		± 0.1	± 0.7	LSB (max)
GE	Gain Error		± 0.2	± 1	LSB (max)
DYNAMIC CONVERTER CHARACTERISTICS					
SINAD	Signal-to-Noise Plus Distortion Ratio	$f_{IN} = 100$ kHz	61.7	61	dBFS (min)
SNR	Signal-to-Noise Ratio	$f_{IN} = 100$ kHz	62		dB
THD	Total Harmonic Distortion	$f_{IN} = 100$ kHz	-77	-73	dB (max)
SFDR	Spurious-Free Dynamic Range	$f_{IN} = 100$ kHz	78	74	dB (min)
IMD	Intermodulation Distortion, Second Order Terms	$f_a = 103.5$ kHz, $f_b = 113.5$ kHz	-78		dB
	Intermodulation Distortion, Third Order Terms	$f_a = 103.5$ kHz, $f_b = 113.5$ kHz	-78		dB
FPBW	-3 dB Full Power Bandwidth	+5V Supply	11		MHz
		+3V Supply	8		MHz
POWER SUPPLY CHARACTERISTICS					
V_{DD}	Supply Voltage			2.7 5.25	V (min) V (max)
I_{DD}	Normal Mode (Static)	$V_{DD} = +4.75V$ to $+5.25V$, SCLK On or Off	2		mA
		$V_{DD} = +2.7V$ to $+3.6V$, SCLK On or Off	1		mA
	Normal Mode (Operational)	$V_{DD} = +4.75V$ to $+5.25V$, $f_{SAMPLE} = 1$ MSPS	2.0	3.5	mA (max)
		$V_{DD} = +2.7V$ to $+3.6V$, $f_{SAMPLE} = 1$ MSPS	0.6	1.6	mA (max)
Shutdown Mode	$V_{DD} = +5V$, SCLK Off	0.5		μA (max)	
	$V_{DD} = +5V$, SCLK On	60		μA (max)	
P_D	Power Consumption, Normal Mode (Operational)	$V_{DD} = +5V$, $f_{SAMPLE} = 1$ MSPS	10	17.5	mW (max)
		$V_{DD} = +3V$, $f_{SAMPLE} = 1$ MSPS	2	4.8	mW (max)
	Power Consumption, Shutdown Mode	$V_{DD} = +5V$, SCLK Off	2.5		μW (max)
		$V_{DD} = +3V$, SCLK Off	1.5		μW (max)
ANALOG INPUT CHARACTERISTICS					
V_{IN}	Input Range		0 to V_{DD}		V
I_{DCL}	DC Leakage Current			± 1	μA (max)
C_{INA}	Analog Input Capacitance		30		pF

Symbol	Parameter	Conditions	Typical	Limits	Units
DIGITAL INPUT CHARACTERISTICS					
V_{IH}	Input High Voltage			2.4	V (min)
V_{IL}	Input Low Voltage	$V_{DD} = +5V$		0.8	V (max)
		$V_{DD} = +3V$		0.4	V (max)
I_{IN}	Input Current	$V_{IN} = 0V$ or V_{DD}	± 10 nA	± 1	μA (max)
C_{IND}	Digital Input Capacitance		2	4	pF (max)
DIGITAL OUTPUT CHARACTERISTICS					
V_{OH}	Output High Voltage	$I_{SOURCE} = 200 \mu A$, $V_{DD} = +2.7V$ to $+5.25V$		$V_{DD} - 0.2$	V (min)
V_{OL}	Output Low Voltage	$I_{SINK} = 200 \mu A$		0.4	V (max)
I_{OL}	TRI-STATE Leakage Current			± 10	μA (max)
C_{OUT}	TRI-STATE Output Capacitance		2	4	pF (max)
	Output Coding		Straight (Natural) Binary		
AC ELECTRICAL CHARACTERISTICS					
f_{SCLK}	Clock Frequency			20	MHz (max)
DC	SCLK Duty Cycle			40	% (min)
				60	% (max)
t_{TH}	Track/Hold Acquisition Time			400	ns (max)
f_{RATE}	Throughput Rate	See Serial Interface Section		1	MSPS (max)
t_{AD}	Aperture Delay		3		ns
t_{AJ}	Aperture Jitter		30		ps

ADCS7478 Converter Electrical Characteristics

The following specifications apply for $V_{DD} = +2.7V$ to $5.25V$, $f_{SCLK} = 20$ MHz, $f_{SAMPLE} = 1$ MSPS unless otherwise noted. **Boldface limits apply for $T_A = -40^\circ C$ to $+85^\circ C$** ; all other limits $T_A = 25^\circ C$, unless otherwise noted.

Symbol	Parameter	Conditions	Typical	Limits	Units
STATIC CONVERTER CHARACTERISTICS					
	Resolution with No Missing Codes			8	Bits
INL	Integral Non-Linearity		± 0.05	± 0.3	LSB (max)
DNL	Differential Non-Linearity		± 0.07	± 0.3	LSB (max)
V_{OFF}	Offset Error		± 0.03	± 0.3	LSB (max)
GE	Gain Error		± 0.08	± 0.4	LSB (max)
	Total Unadjusted Error		± 0.07	± 0.3	LSB (max)
DYNAMIC CONVERTER CHARACTERISTICS					
SINAD	Signal-to-Noise Plus Distortion Ratio	$f_{IN} = 100$ kHz	49.7	49	dB (min)
SNR	Signal-to-Noise Ratio	$f_{IN} = 100$ kHz	49.7		dB
THD	Total Harmonic Distortion	$f_{IN} = 100$ kHz	-77	-65	dB (max)
SFDR	Spurious-Free Dynamic Range	$f_{IN} = 100$ kHz	69	65	dB (min)
IMD	Intermodulation Distortion, Second Order Terms	$f_a = 103.5$ kHz, $f_b = 113.5$ kHz	-68		dB
	Intermodulation Distortion, Third Order Terms	$f_a = 103.5$ kHz, $f_b = 113.5$ kHz	-68		dB
FPBW	-3 dB Full Power Bandwidth	+5V Supply	11		MHz
		+3V Supply	8		MHz
POWER SUPPLY CHARACTERISTICS					
V_{DD}	Supply Voltage			2.7 5.25	V (min) V (max)
I_{DD}	Normal Mode (Static)	$V_{DD} = +4.75V$ to $+5.25V$, SCLK On or Off	2		mA
		$V_{DD} = +2.7V$ to $+3.6V$, SCLK On or Off	1		mA
	Normal Mode (Operational)	$V_{DD} = +4.75V$ to $+5.25V$, $f_{SAMPLE} = 1$ MSPS	2.0	3.5	mA (max)
		$V_{DD} = +2.7V$ to $+3.6V$, $f_{SAMPLE} = 1$ MSPS	0.6	1.6	mA (max)
	Shutdown Mode	$V_{DD} = +5V$, SCLK Off	0.5		μA (max)
$V_{DD} = +5V$, SCLK On		60		μA (max)	
P_D	Power Consumption, Normal Mode (Operational)	$V_{DD} = +5V$, $f_{SAMPLE} = 1$ MSPS	10	17.5	mW (max)
		$V_{DD} = +3V$, $f_{SAMPLE} = 1$ MSPS	2	4.8	mW (max)
	Power Consumption= Shutdown Mode	$V_{DD} = +5V$, SCLK Off	2.5		μW (max)
		$V_{DD} = +3V$, SCLK Off	1.5		μW (max)
ANALOG INPUT CHARACTERISTICS					
V_{IN}	Input Range		0 to V_{DD}		V
I_{DCL}	DC Leakage Current			± 1	μA (max)
C_{INA}	Analog Input Capacitance		30		pF

Symbol	Parameter	Conditions	Typical	Limits	Units
DIGITAL INPUT CHARACTERISTICS					
V_{IH}	Input High Voltage			2.4	V (min)
V_{IL}	Input Low Voltage	$V_{DD} = +5V$		0.8	V (max)
		$V_{DD} = +3V$		0.4	V (max)
I_{IN}	Digital Input Current	$V_{IN} = 0V$ or V_{DD}	± 10 nA	± 1	μA (max)
C_{IND}	Input Capacitance		2	4	pF(max)
DIGITAL OUTPUT CHARACTERISTICS					
V_{OH}	Output High Voltage	$I_{SOURCE} = 200 \mu A$, $V_{DD} = +2.7V$ to $+5.25V$		$V_{DD} - 0.2$	V (min)
V_{OL}	Output Low Voltage	$I_{SINK} = 200 \mu A$		0.4	V (max)
I_{OL}	TRI-STATE Leakage Current			± 10	μA (max)
C_{OUT}	TRI-STATE Output Capacitance		2	4	pF (max)
	Output Coding		Straight (Natural) Binary		
AC ELECTRICAL CHARACTERISTICS					
f_{SCLK}	Clock Frequency			20	MHz (max)
DC	SCLK Duty Cycle			40	% (min)
				60	% (max)
t_{TH}	Track/Hold Acquisition Time			400	ns (max)
f_{RATE}	Throughput Rate	See Applications Section		1	MSPS (min)
t_{AD}	Aperture Delay		3		ns
t_{AJ}	Aperture Jitter		30		ps

Note 1: Absolute maximum ratings are limiting values, to be applied individually, and beyond which the serviceability of the circuit may be impaired. Functional operability under any of these conditions is not implied. Exposure to maximum ratings for extended periods may affect device reliability.

Note 2: Data sheet min/max specification limits are guaranteed by design, test, or statistical analysis.

Note 3: Except power supply pins.

Note 4: Independent of supply voltage.

Timing Test Circuit

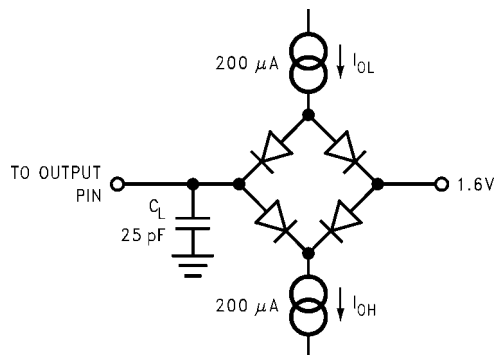

20057708

ADCS7476/ADCS7477/ADCS7478 Timing Specifications

The following specifications apply for $V_{DD} = +2.7V$ to $5.25V$, $f_{SCLK} = 20$ MHz, **Boldface limits apply for $T_A = -40^\circ C$ to $+85^\circ C$** ; all other limits $T_A = 25^\circ C$, unless otherwise noted. (*Note 9*)

Symbol	Parameter	Conditions	Typical	Limits	Units
$t_{CONVERT}$			$16 \times t_{SCLK}$		
t_{QUIET}	(<i>Note 5</i>)			50	ns (min)
t_1	Minimum \overline{CS} Pulse Width			10	ns (min)
t_2	\overline{CS} to SCLK Setup Time			10	ns (min)
t_3	Delay from \overline{CS} Until SDATA TRI-STATE Disabled (<i>Note 6</i>)			20	ns (max)
t_4	Data Access Time after SCLK Falling Edge (<i>Note 7</i>)	$V_{DD} = +2.7$ to $+3.6$		40	ns (max)
		$V_{DD} = +4.75$ to $+5.25$		20	ns (max)
t_5	SCLK Low Pulse Width			$0.4 \times t_{SCLK}$	ns (min)
t_6	SCLK High Pulse Width			$0.4 \times t_{SCLK}$	ns (min)
t_7	SCLK to Data Valid Hold Time	$V_{DD} = +2.7$ to $+3.6$		7	ns (min)
		$V_{DD} = +4.75$ to $+5.25$		5	ns (min)
t_8	SCLK Falling Edge to SDATA High Impedance (<i>Note 8</i>)	$V_{DD} = +2.7$ to $+3.6$		25	ns (max)
				6	ns (min)
		$V_{DD} = +4.75$ to $+5.25$		25	ns (max)
				5	ns (min)
$t_{POWER-UP}$	Power-Up Time from Full Power-Down		1		μs

Note 5: Minimum Quiet Time Required Between Bus Relinquish and Start of Next Conversion

Note 6: Measured with the load circuit shown above, and defined as the time taken by the output to cross 1.0V.

Note 7: Measured with the load circuit shown above, and defined as the time taken by the output to cross 1.0V or 2.0V.

Note 8: t_8 is derived from the time taken by the outputs to change by 0.5V with the loading circuit shown above. The measured number is then adjusted to remove the effects of charging or discharging the 25pF capacitor. This means t_8 is the true bus relinquish time, independent of the bus loading.

Note 9: All input signals are specified as $t_r = t_f = 5$ ns (10% to 90% V_{DD}) and timed from 1.6V.

Specification Definitions

APERTURE DELAY is the time after the falling edge of \overline{CS} to when the input signal is acquired or held for conversion.

APERTURE JITTER (APERTURE UNCERTAINTY) is the variation in aperture delay from sample to sample. Aperture jitter manifests itself as noise in the output.

DIFFERENTIAL NON-LINEARITY (DNL) is the measure of the maximum deviation from the ideal step size of 1 LSB.

DUTY CYCLE is the ratio of the time that a repetitive digital waveform is high to the total time of one period. The specification here refers to the SCLK.

EFFECTIVE NUMBER OF BITS (ENOB, or EFFECTIVE BITS) is another method of specifying Signal-to-Noise and Distortion or SINAD. ENOB is defined as $(\text{SINAD} - 1.76) / 6.02$ and says that the converter is equivalent to a perfect ADC of this (ENOB) number of bits.

FULL POWER BANDWIDTH is a measure of the frequency at which the reconstructed output fundamental drops 3 dB below its low frequency value for a full scale input.

GAIN ERROR is the deviation of the last code transition (111...110) to (111...111) from the ideal ($V_{REF} - 1.5$ LSB for ADCS7476 and ADCS7477, $V_{REF} - 1$ LSB for ADCS7478), after adjusting for offset error.

INTEGRAL NON-LINEARITY (INL) is a measure of the deviation of each individual code from a line drawn from negative full scale ($\frac{1}{2}$ LSB below the first code transition) through positive full scale ($\frac{1}{2}$ LSB above the last code transition). The deviation of any given code from this straight line is measured from the center of that code value.

INTERMODULATION DISTORTION (IMD) is the creation of additional spectral components as a result of two sinusoidal frequencies being applied to the ADC input at the same time. It is defined as the ratio of the power in either the two second order or all four third order intermodulation products to the sum of the power in both of the original frequencies. IMD is usually expressed in dBFS.

MISSING CODES are those output codes that will never appear at the ADC outputs. The ADCS7476/77/78 is guaranteed not to have any missing codes.

OFFSET ERROR is the deviation of the first code transition (000...000) to (000...001) from the ideal (i.e. GND + 0.5 LSB for the ADCS7476 and ADCS7477, and GND + 1 LSB for the ADCS7478).

SIGNAL TO NOISE RATIO (SNR) is the ratio, expressed in dB, of the rms value of the input signal to the rms value of the sum of all other spectral components below one-half the sampling frequency, not including harmonics or DC.

SIGNAL TO NOISE PLUS DISTORTION (S/N+D or SINAD) is the ratio, expressed in dB, of the rms value of the input signal to the rms value of all of the other spectral components below half the clock frequency, including harmonics but excluding DC.

SPURIOUS FREE DYNAMIC RANGE (SFDR) is the difference, expressed in dB, between the rms values of the input signal and the peak spurious signal, where a spurious signal is any signal present in the output spectrum that is not present at the input.

TOTAL HARMONIC DISTORTION (THD) is the ratio, expressed in dBc, of the rms total of the first five harmonic levels at the output to the level of the fundamental at the output. THD is calculated as

$$\text{THD} = 20 \times \log \sqrt{\frac{f_2^2 + \dots + f_6^2}{f_1^2}}$$

where f_1 is the RMS power of the fundamental (output) frequency and f_2 through f_6 are the RMS power in the first 5 harmonic frequencies.

TOTAL UNADJUSTED ERROR is the worst deviation found from the ideal transfer function. As such, it is a comprehensive specification which includes full scale error, linearity error, and offset error.

Timing Diagrams

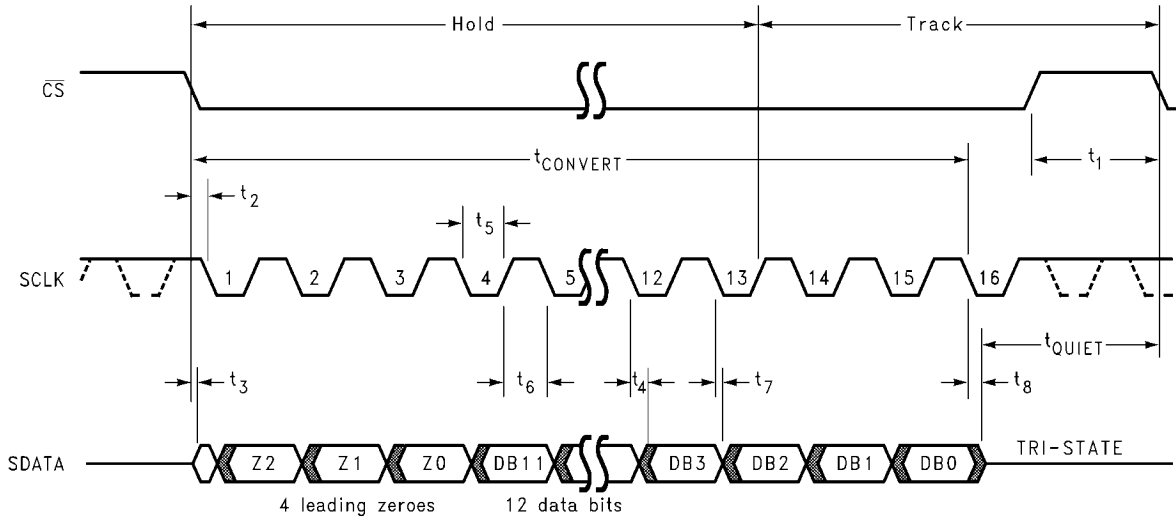

20057702

FIGURE 1. ADCS7476 Serial Interface Timing Diagram

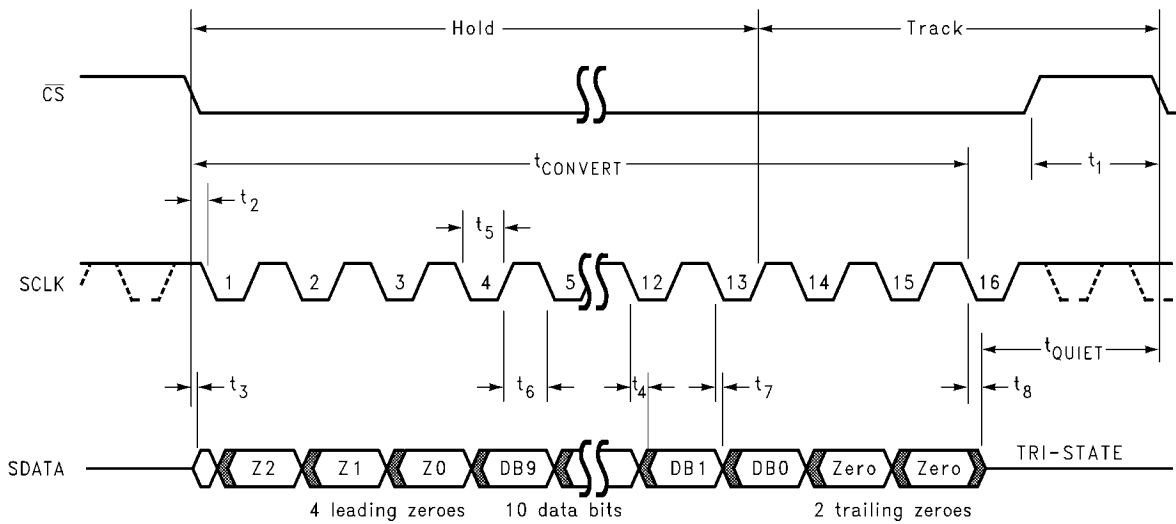

20057703

FIGURE 2. ADCS7477 Serial Interface Timing Diagram

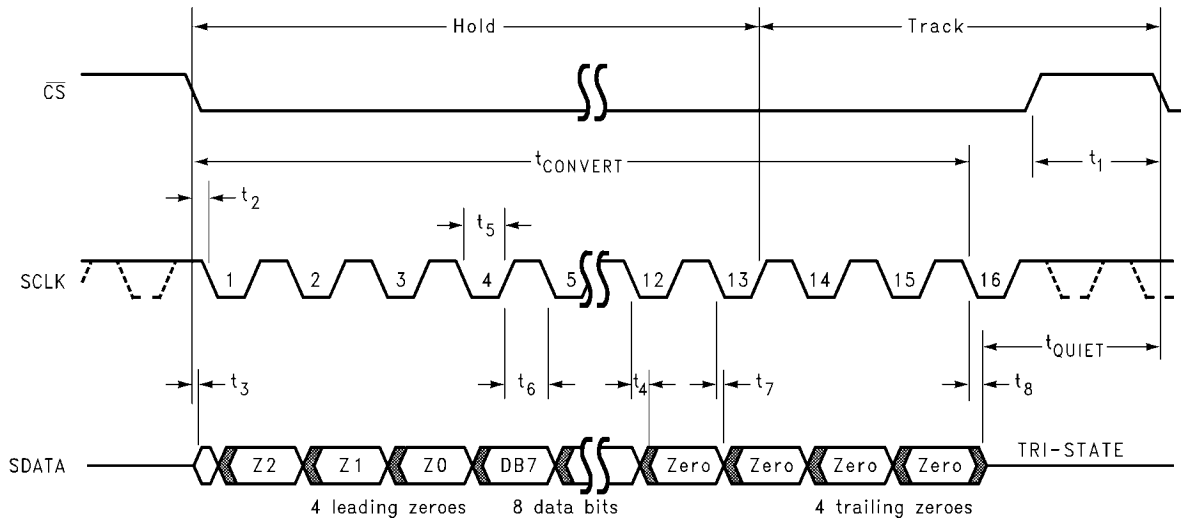

20057704

FIGURE 3. ADCS7478 Serial Interface Timing Diagram

Typical Performance Characteristics

100 kHz unless otherwise stated.

$T_A = +25^\circ\text{C}$, $V_{DD} = 3\text{V}$, $f_{\text{SAMPLE}} = 1\text{ MSPS}$, $f_{\text{SCLK}} = 20\text{ MHz}$, $f_{\text{IN}} =$

ADCS7476

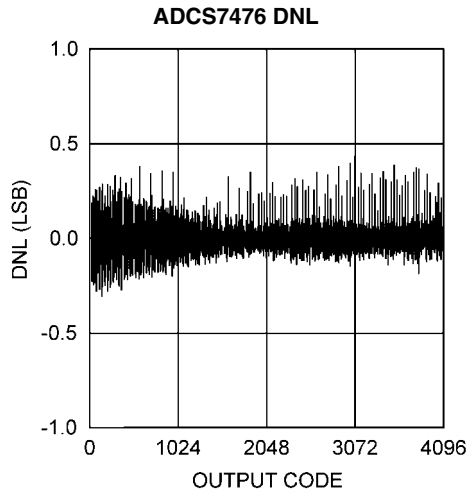

20057706

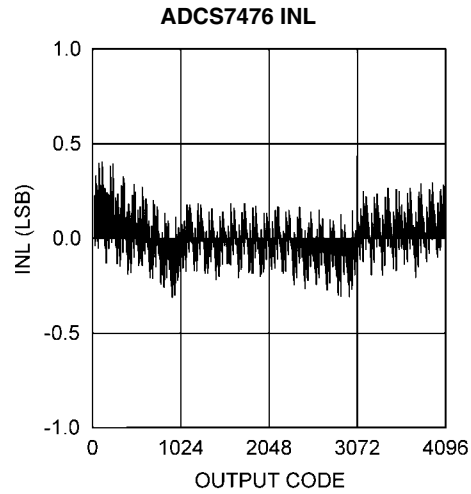

20057705

ADCS7476 Spectral Response @ 100kHz Input

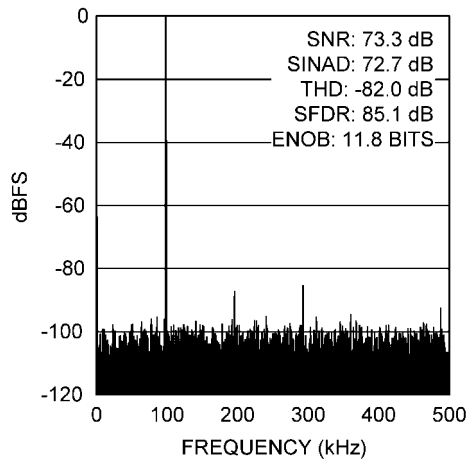

20057707

ADCS7476 THD vs. Source Impedance

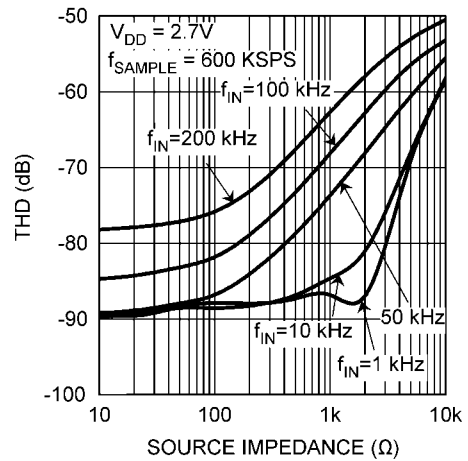

20057750

ADCS7476 THD vs. Input Frequency, 600 kSPS

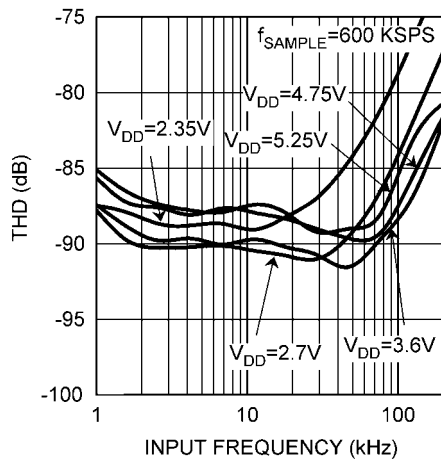

20057751

ADCS7476 THD vs. Input Frequency, 1 MSPS

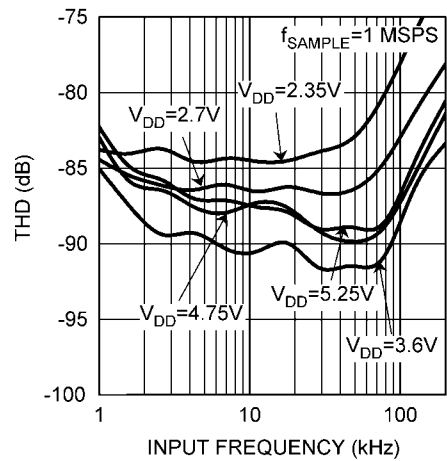

20057752

ADCS7476 SINAD vs. Input Frequency, 600 kSPS

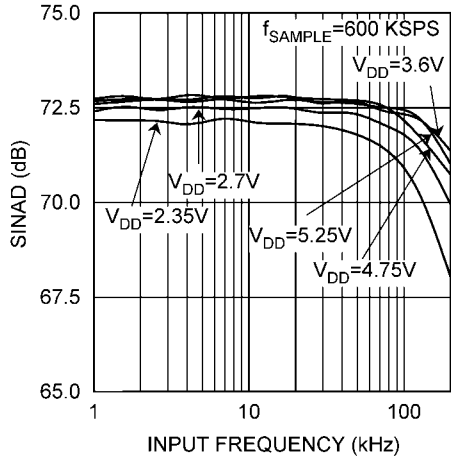

20057753

ADCS7476 SINAD vs. Input Frequency, 1 MSPS

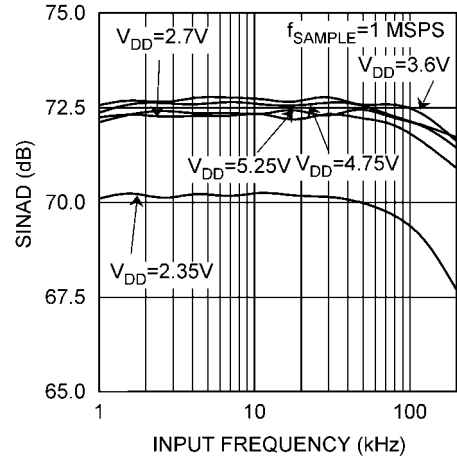

20057754

ADCS7476 SNR vs. f_{SCLK}

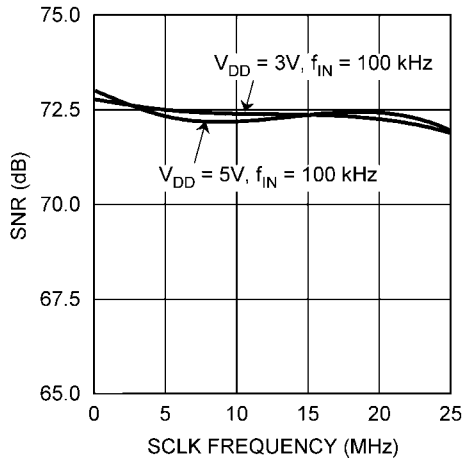

20057756

ADCS7476 SINAD vs. f_{SCLK}

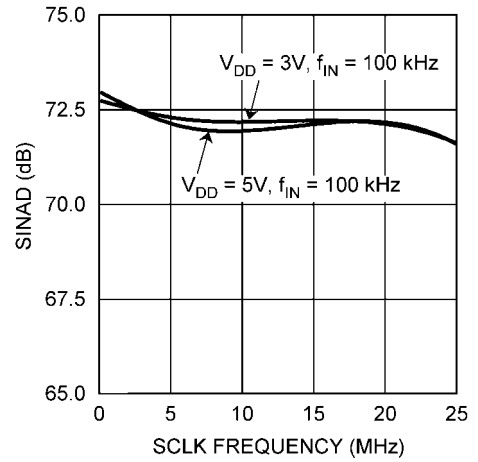

20057757

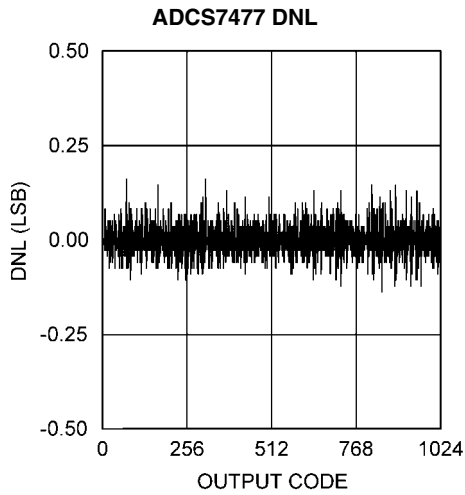

20057770

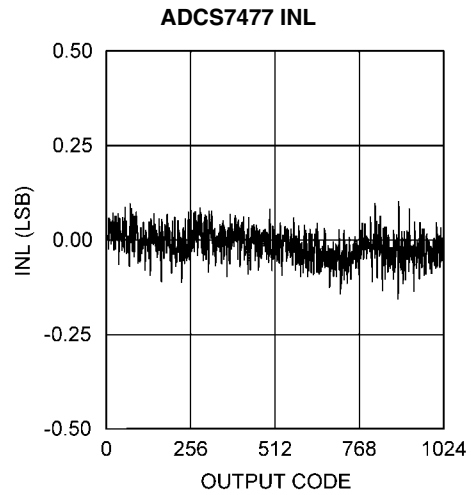

20057771

ADCS7477 Spectral Response @ 100kHz Input

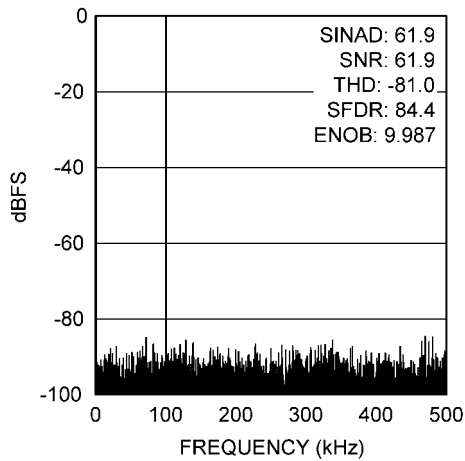

20057772

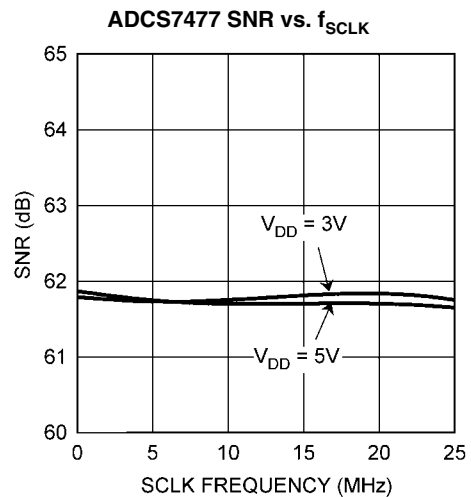

20057773

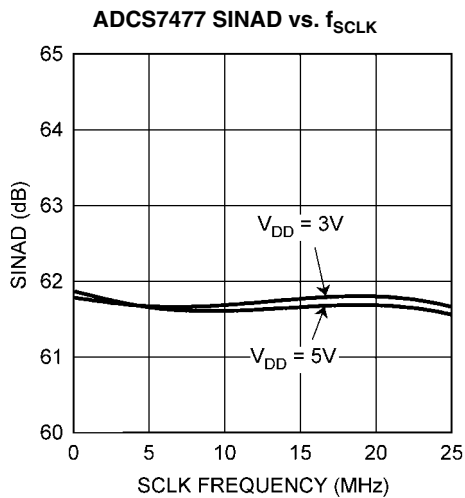

20057774

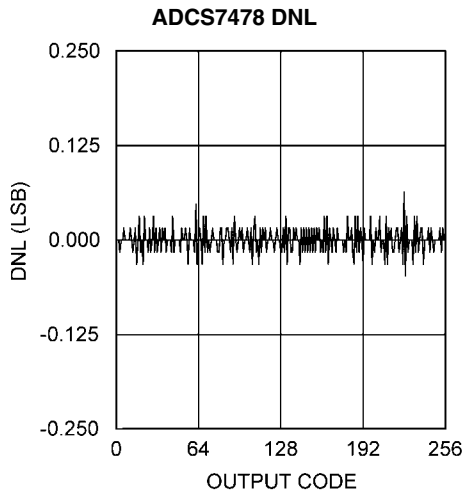

20057760

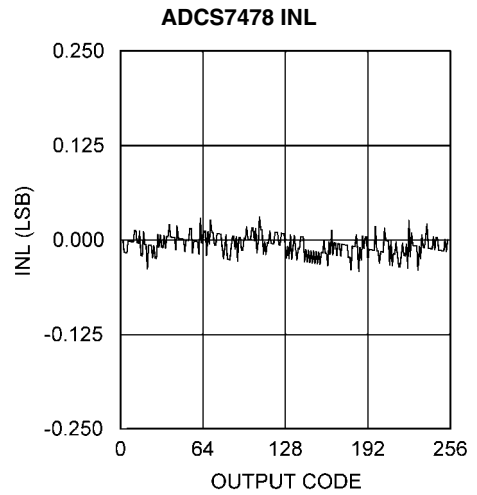

20057761

ADCS7478 Spectral Response @ 100kHz Input

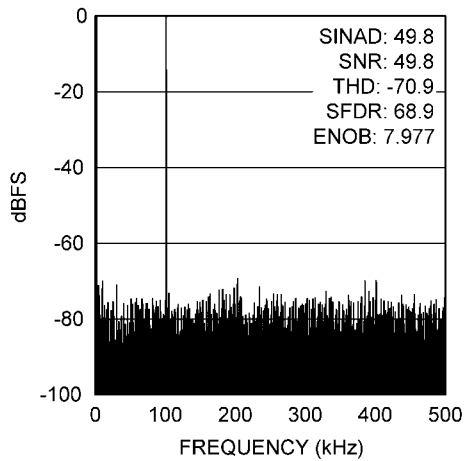

20057762

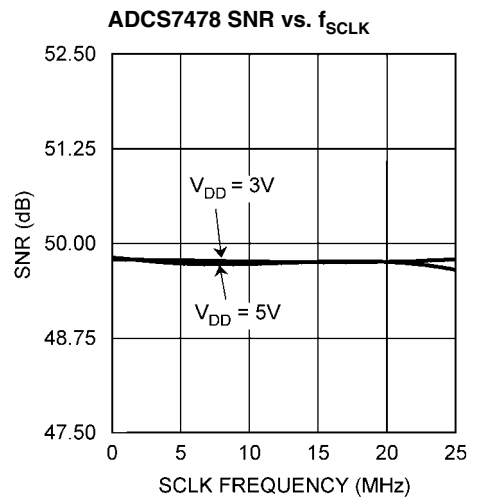

20057763

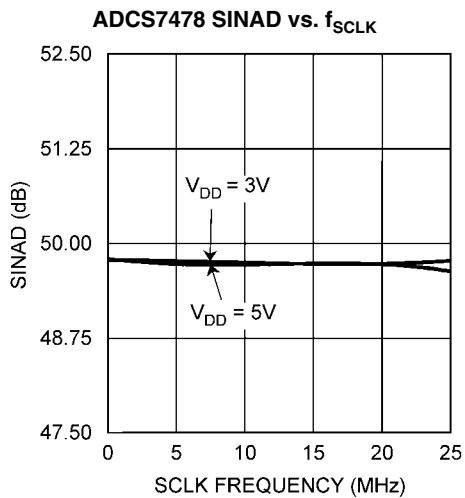

20057764

Applications Information

1.0 ADCS7476/77/78 OPERATION

The ADCS7476/77/78 are successive-approximation analog-to-digital converters designed around a charge-redistribution digital-to-analog converter. Simplified schematics of the ADCS7476/77/78 in both track and hold operation are shown in [Figure 4](#) and [Figure 5](#), respectively. In [Figure 4](#) the device is in track mode: switch SW1 connects the sampling capacitor to the input, and SW2 balances the comparator inputs. The device is in this state until \overline{CS} is brought low, at which point the device moves to hold mode.

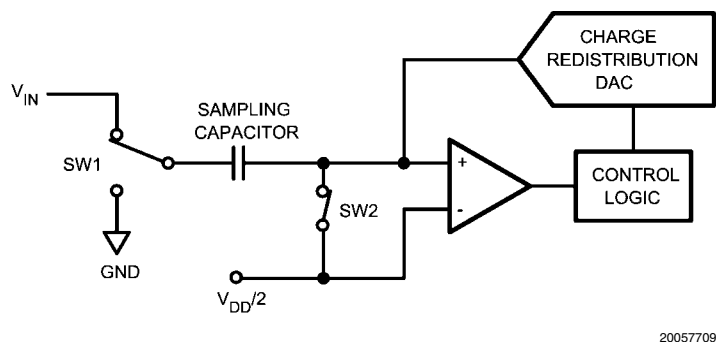

FIGURE 4. ADCS7476/77/78 in Track Mode

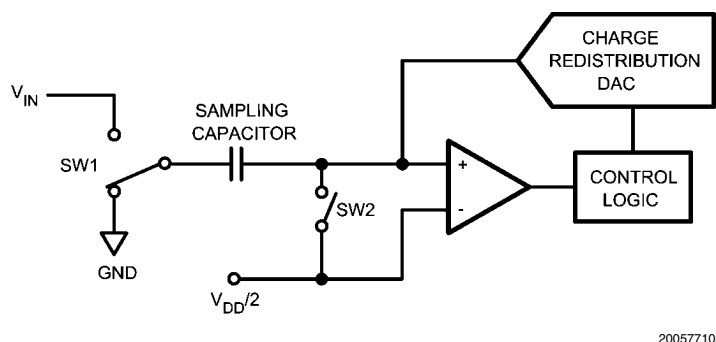

FIGURE 5. ADCS7476/77/78 in Hold Mode

2.0 USING THE ADCS7476/77/78

Serial interface timing diagrams for the ADCS7476/77/78 are shown in [Figure 1](#), [Figure 2](#), and [Figure 3](#). \overline{CS} is chip select, which initiates conversions and frames the serial data transfers. SCLK (serial clock) controls both the conversion process and the timing of serial data. SDATA is the serial data out pin, where a conversion result is found.

Basic operation of the ADCS7476/77/78 begins with \overline{CS} going low, which initiates a conversion process and data transfer. Subsequent rising and falling edges of SCLK will be labelled with reference to the falling edge of \overline{CS} ; for example, "the third falling edge of SCLK" shall refer to the third falling edge of SCLK after \overline{CS} goes low.

At the fall of \overline{CS} , the SDATA pin comes out of TRI-STATE, and the converter moves from track mode to hold mode. The input signal is sampled and held for conversion at the falling edge of \overline{CS} . The converter moves from hold mode to track mode on the 13th rising edge of SCLK (see [Figure 1](#), [Figure 2](#), or [Figure 3](#)). The SDATA pin will be placed back into

[Figure 5](#) shows the device in hold mode: switch SW1 connects the sampling capacitor to ground, maintaining the sampled voltage, and switch SW2 unbalances the comparator. The control logic then instructs the charge-redistribution DAC to add or subtract fixed amounts of charge from the sampling capacitor until the comparator is balanced. When the comparator is balanced, the digital word supplied to the DAC is the digital representation of the analog input voltage. The device moves from hold mode to track mode on the 13th rising edge of SCLK.

TRI-STATE after the 16th falling edge of SCLK, or at the rising edge of \overline{CS} , whichever occurs first. After a conversion is completed, the quiet time t_{QUIET} must be satisfied before bringing \overline{CS} low again to begin another conversion.

Sixteen SCLK cycles are required to read a complete sample from the ADCS7476/77/78. The sample bits (including any leading or trailing zeroes) are clocked out on falling edges of SCLK, and are intended to be clocked in by a receiver on subsequent falling edges of SCLK. The ADCS7476/77/78 will produce four leading zeroes on SDATA, followed by twelve, ten, or eight data bits, most significant first. After the data bits, the ADCS7477 will clock out two trailing zeros, and the ADCS7478 will clock out four trailing zeros. The ADCS7476 will not clock out any trailing zeros; the least significant data bit will be valid on the 16th falling edge of SCLK.

Depending upon the application, the first edge on SCLK after \overline{CS} goes low may be either a falling edge or a rising edge. If the first SCLK edge after \overline{CS} goes low is a rising edge, all four leading zeroes will be valid on the first four falling edges of

SCLK. If instead the first SCLK edge after \overline{CS} goes low is a falling edge, the first leading zero may not be set up in time for a microprocessor or DSP to read it correctly. The remaining data bits are still clocked out on the falling edges of SCLK.

3.0 ADCS7476/77/78 TRANSFER FUNCTION

The output format of the ADCS7476/77/78 is straight binary. Code transitions occur midway between successive integer

LSB values. The LSB widths for the ADCS7476 is $V_{DD} / 4096$; for the ADCS7477 the LSB width is $V_{DD} / 1024$; for the ADCS7478, the LSB width is $V_{DD} / 256$. The ideal transfer characteristic for the ADCS7476 and ADCS7477 is shown in *Figure 6*, while the ideal transfer characteristic for the ADCS7478 is shown in *Figure 7*.

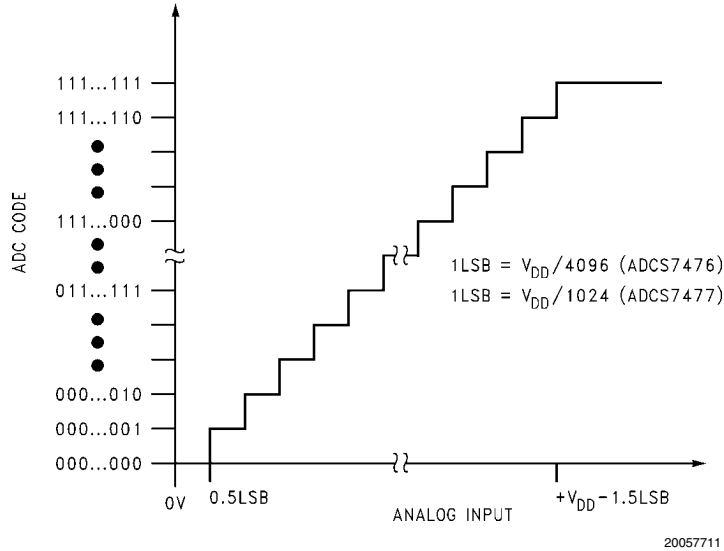

FIGURE 6. ADCS7476/77 Ideal Transfer Characteristic

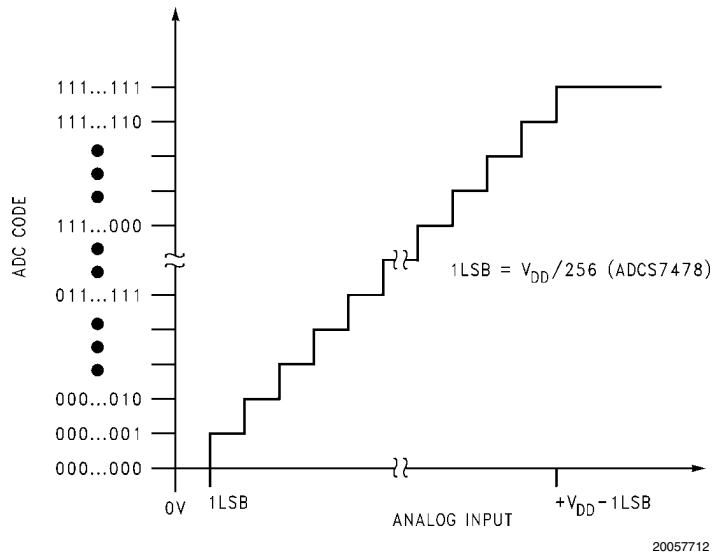

FIGURE 7. ADCS7478 Ideal Transfer Characteristic

4.0 TYPICAL APPLICATION CIRCUIT

A typical application of the ADCS7476/77/78 is shown in *Figure 8*. The combined analog and digital supplies are provided in this example by the National LP2950 low-dropout voltage regulator, available in a variety of fixed and adjustable output voltages. The supply is bypassed with a capacitor network located close to the device. The three-wire interface is also shown connected to a microprocessor or DSP.

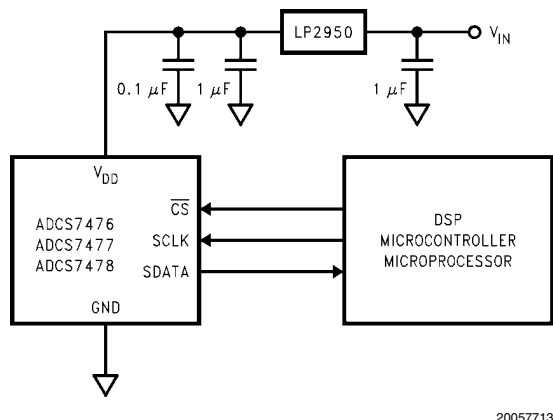

FIGURE 8. Typical Application Circuit

5.0 ANALOG INPUTS

An equivalent circuit for the ADCS7476/77/78 input channel is shown in *Figure 9*. The diodes D1 and D2 provide ESD protection for the analog inputs. At no time should an analog input exceed $V_{DD} + 300\text{ mV}$ or $GND - 300\text{ mV}$, as these ESD diodes will begin conducting current into the substrate or supply line and affect ADC operation.

The capacitor C1 in *Figure 9* typically has a value of 4 pF, and is mainly due to pin capacitance. The resistor R1 represents the on resistance of the multiplexer and track / hold switch, and is typically 100 ohms. The capacitor C2 is the ADCS7476/77/78 sampling capacitor, and is typically 26 pF.

The sampling nature of the analog input causes input current pulses that result in voltage spikes at the input. The ADCS7476/77/78 will deliver best performance when driven by a low-impedance source to eliminate distortion caused by the charging of the sampling capacitance. In applications where dynamic performance is critical, the input might need to be driven with a low output-impedance amplifier. In addition, when using the ADCS7476/77/78 to sample AC signals, a band-pass or low-pass filter will reduce harmonics and noise and thus improve THD and SNR.

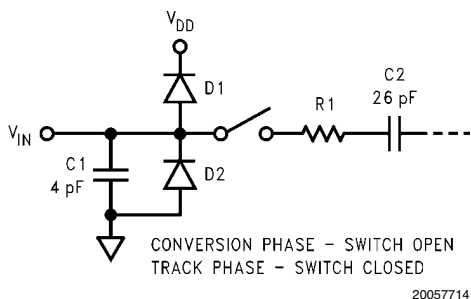

FIGURE 9. Equivalent Input Circuit

6.0 DIGITAL INPUTS AND OUTPUTS

The ADCS7476/77/78 digital inputs (SCLK and \overline{CS}) are not limited by the same absolute maximum ratings as the analog inputs. The digital input pins are instead limited to +6.5V with respect to GND, regardless of V_{DD} , the supply voltage. This allows the ADCS7476/77/78 to be interfaced with a wide range of logic levels, independent of the supply voltage.

Note that, even though the digital inputs are tolerant of up to +6.5V above GND, the digital outputs are only capable of driving V_{DD} out. In addition, the digital input pins are not prone to latch-up; SCLK and \overline{CS} may be asserted before V_{DD} without any risk.

7.0 MODES OF OPERATION

The ADCS7476/77/78 has two possible modes of operation: normal mode, and shutdown mode. The ADCS7476/77/78 enters normal mode (and a conversion process is begun) when \overline{CS} is pulled low. The device will enter shutdown mode if \overline{CS} is pulled high before the tenth falling edge of SCLK after \overline{CS} is pulled low, or will stay in normal mode if \overline{CS} remains low. Once in shutdown mode, the device will stay there until \overline{CS} is brought low again. By varying the ratio of time spent in the normal and shutdown modes, a system may trade-off throughput for power consumption.

8.0 NORMAL MODE

The best possible throughput is obtained by leaving the ADCS7476/77/78 in normal mode at all times, so there are no power-up delays. To keep the device in normal mode continuously, \overline{CS} must be kept low until after the 10th falling edge of SCLK after the start of a conversion (remember that a conversion is initiated by bringing \overline{CS} low).

If \overline{CS} is brought high after the 10th falling edge, but before the 16th falling edge, the device will remain in normal mode, but the current conversion will be aborted, and SDATA will return to TRI-STATE (truncating the output word).

Sixteen SCLK cycles are required to read all of a conversion word from the device. After sixteen SCLK cycles have elapsed, \overline{CS} may be idled either high or low until the next conversion. If \overline{CS} is idled low, it must be brought high again before the start of the next conversion, which begins when \overline{CS} is again brought low.

After sixteen SCLK cycles, SDATA returns to TRI-STATE. Another conversion may be started, after t_{QUIET} has elapsed, by bringing \overline{CS} low again.

9.0 SHUTDOWN MODE

Shutdown mode is appropriate for applications that either do not sample continuously, or are willing to trade throughput for power consumption. When the ADCS7476/77/78 is in shutdown mode, all of the analog circuitry is turned off.

To enter shutdown mode, a conversion must be interrupted by bringing \overline{CS} back high anytime between the second and tenth falling edges of SCLK, as shown in *Figure 10*. Once \overline{CS} has been brought high in this manner, the device will enter shutdown mode; the current conversion will be aborted and SDATA will enter TRI-STATE. If \overline{CS} is brought high before the second falling edge of SCLK, the device will not change mode; this is to avoid accidentally changing mode as a result of noise on the \overline{CS} line.

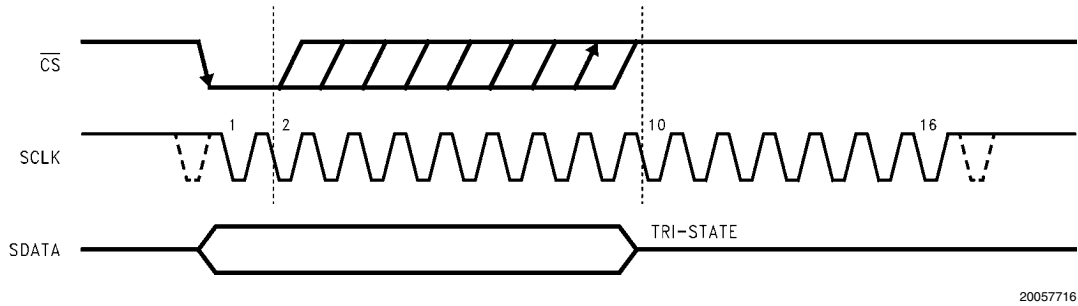

FIGURE 10. Entering Shutdown Mode

10.0 EXITING SHUTDOWN MODE

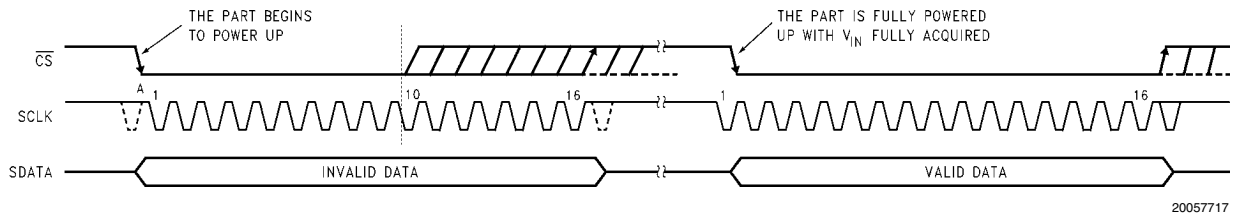

FIGURE 11. Entering Normal Mode

To exit shutdown mode, bring \overline{CS} back low. Upon bringing \overline{CS} low, the ADCS7476/77/78 will begin powering up. Power up typically takes 1 μ s. This microsecond of power-up delay results in the first conversion result being unusable. The second conversion performed after power-up, however, is valid, as shown in *Figure 11*.

If \overline{CS} is brought back high before the 10th falling edge of SCLK, the device will return to shutdown mode. This is done to avoid accidentally entering normal mode as a result of noise on the \overline{CS} line. To exit shutdown mode and remain in normal mode, \overline{CS} must be kept low until after the 10th falling edge of SCLK. The ADCS7476/77/78 will be fully powered-up after 16 SCLK cycles.

11.0 POWER-UP TIMING

The ADCS7476/77/78 typically requires 1 μ s to power up, either after first applying V_{DD} , or after returning to normal mode from shutdown mode. This corresponds to one "dummy" conversion for any SCLK frequency within the specifications in this document. After this first dummy conversion, the ADCS7476/77/78 will perform conversions properly. Note that the t_{QUIET} time must still be included between the first dummy conversion and the second valid conversion.

12.0 STARTUP MODE

When the V_{DD} supply is first applied, the ADCS7476/77/78 may power up in either of the two modes: normal or shutdown. As such, one dummy conversion should be performed after start-up, exactly as described in *Section 11.0 POWER-UP TIMING*. The part may then be placed into either normal mode or the shutdown mode, as described in *Section 8.0 NORMAL MODE* and *Section 9.0 SHUTDOWN MODE*.

13.0 POWER CONSIDERATIONS

There are three concerns relating to the power supply of these products: the effects of power supply noise upon the conversion process, the digital output loading effects upon the con-

version process and managing total power consumption of the product.

13.1 Power Supply Noise

Since the reference voltage of the ADCS7476/77/78 is the reference voltage, any noise greater than 1/2 LSB in amplitude will have some effect upon the converter noise performance. This effect is proportional to the input voltage level. The power supply should receive all the considerations of a reference voltage as far as stability and noise is concerned. Using the same supply voltage for these devices as is used for digital components will lead to degraded noise performance.

13.2 Digital Output Effect Upon Noise

The charging of any output load capacitance requires current from the digital supply, V_{DD} . The current pulses required from the supply to charge the output capacitance will cause voltage variations at the ADC supply line. If these variations are large enough, they could degrade SNR and SINAD performance of the ADC. Similarly, discharging the output capacitance when the digital output goes from a logic high to a logic low will dump current into the die substrate, causing "ground bounce" noise in the substrate that will degrade noise performance if that current is large enough. The larger the output capacitance, the more current flows through the device power supply line and die substrate and the greater is the noise coupled into the analog path.

The first solution to keeping digital noise out of the power supply is to decouple the supply from any other components or use a separate supply for the ADC. To keep noise out of the supply, keep the output load capacitance as small as practical. If the load capacitance is greater than 50 pF, use a 100 Ω series resistor at the ADC output, located as close to the ADC output pin as practical. This will limit the charge and discharge current of the output capacitance and improve noise performance. Since the series resistor and the load ca-

capacitance form a low frequency pole, verify signal integrity once the series resistor has been added.

13.3 Power Management

When the ADCS7476/77/78 is operated continuously in normal mode, throughput up to 1 MSPS can be achieved. The user may trade throughput for power consumption by simply performing fewer conversions per unit time, and putting the ADCS7476/77/78 into shutdown mode between conversions. This method is not advantageous beyond 350 kSPS throughput.

A plot of maximum power consumption versus throughput is shown in [Figure 12](#). To calculate the power consumption for a given throughput, remember that each time the part exits shutdown mode and enters normal mode, one dummy conversion is required. Generally, the user will put the part into

normal mode, execute one dummy conversion followed by one valid conversion, and then put the part back into shutdown mode. When this is done, the fraction of time spent in normal mode may be calculated by multiplying the throughput (in samples per second) by $2 \mu\text{s}$, the time taken to perform one dummy and one valid conversion. The power consumption can then be found by multiplying the fraction of time spent in normal mode by the normal mode power consumption figure. The power dissipated while the part is in shutdown mode is negligible.

For example, to calculate the power consumption at 300 kSPS with $V_{\text{DD}} = 5\text{V}$, begin by calculating the fraction of time spent in normal mode: $300,000 \text{ samples/second} \times 2 \mu\text{s} = 0.6$, or 60%. The power consumption at 300 kSPS is then 60% of 17.5 mW (the maximum power consumption at $V_{\text{DD}} = 5\text{V}$) or 10.5 mW.

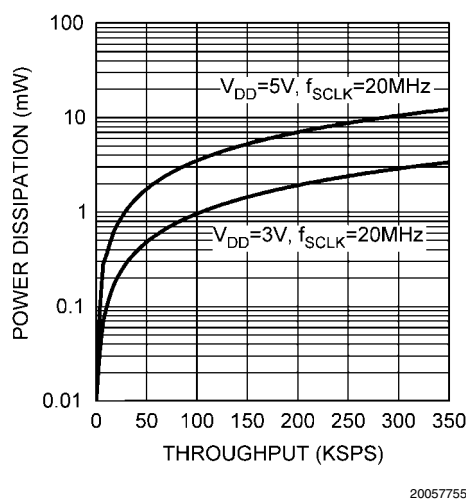

FIGURE 12. Maximum Power Consumption vs. Throughput

14.0 LAYOUT AND GROUNDING

Capacitive coupling between noisy digital circuitry and sensitive analog circuitry can lead to poor performance. The solution is to keep the analog and digital circuitry separated from each other and the clock line as short as possible.

Digital circuits create substantial supply and ground current transients. This digital noise could have significant impact upon system noise performance. To avoid performance degradation of the ADCS7476/77/78 due to supply noise, do not use the same supply for the ADCS7476/77/78 that is used for digital logic.

Generally, analog and digital lines should cross each other at 90° to avoid crosstalk. However, to maximize accuracy in high resolution systems, avoid crossing analog and digital lines altogether. It is important to keep clock lines as short as possible and isolated from ALL other lines, including other digital lines. In addition, the clock line should also be treated as a transmission line and be properly terminated.

The analog input should be isolated from noisy signal lines to avoid coupling of spurious signals into the input. Any external component (e.g., a filter capacitor) connected between the converter's input pins and ground or to the reference input pin and ground should be connected to a very clean point in the ground plane.

We recommend the use of a single, uniform ground plane and the use of split power planes. The power planes should be located within the same board layer. All analog circuitry (input amplifiers, filters, reference components, etc.) should be placed over the analog power plane. All digital circuitry and I/O lines should be placed over the digital power plane. Furthermore, all components in the reference circuitry and the input signal chain that are connected to ground should be connected together with short traces and enter the analog ground plane at a single, quiet point.

Physical Dimensions inches (millimeters) unless otherwise noted

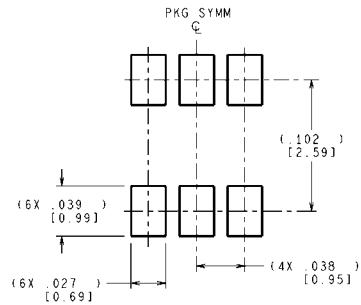
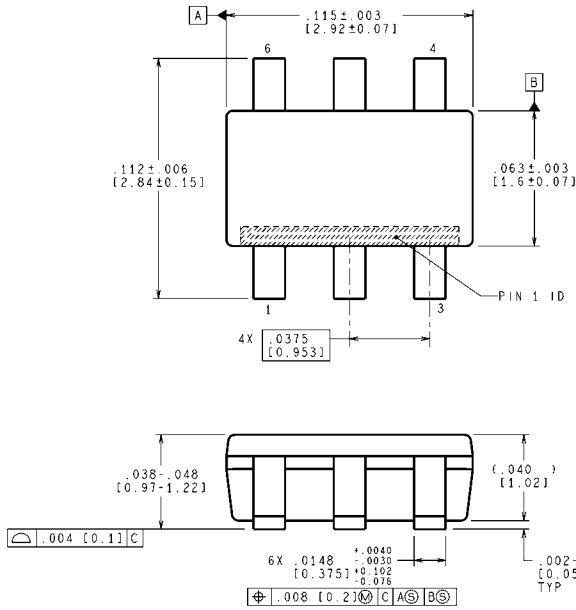

RECOMMENDED LAND PATTERN

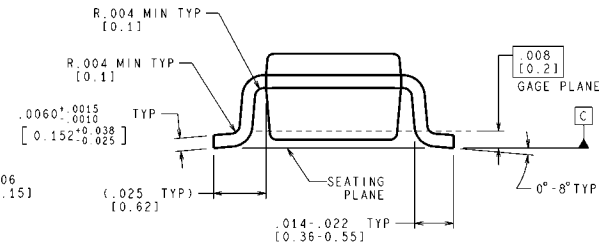

CONTROLLING DIMENSION IS INCH
VALUES IN [] ARE MILLIMETERS
DIMENSIONS IN () FOR REFERENCE ONLY

MF06A (Rev C)

6-Lead SOT-23
Order Number ADCS7476AIMF, ADCS7476AIMFX, ADCS7477AIMF, ADCS7477AIMFX, ADCS7478AIMF or
ADCS7478AIMFX
NS Package Number MF06A

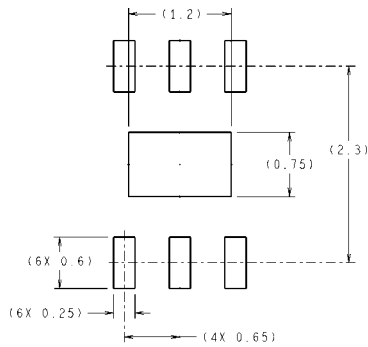

RECOMMENDED LAND PATTERN

DIMENSIONS ARE IN MILLIMETERS
DIMENSIONS IN () FOR REFERENCE ONLY

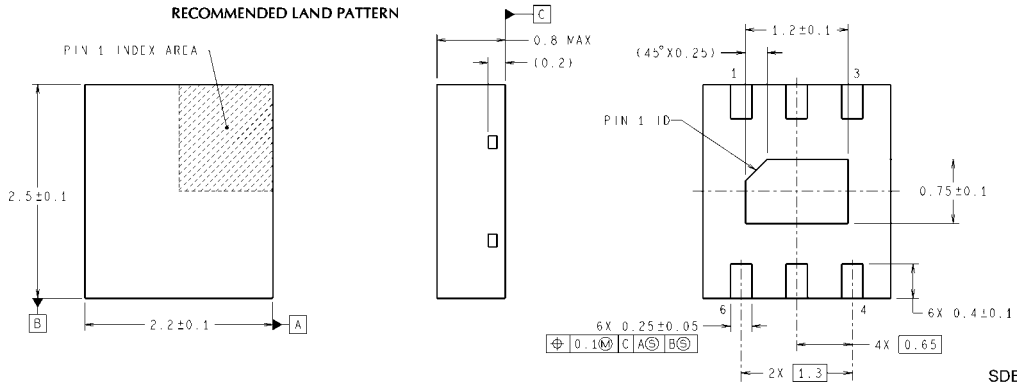

SDB06A (Rev A)

6-Lead LLP
Order Number ADCS7476AISD, ADCS7476AISDX, ADCS7477AISD, ADCS7477AISDX, ADCS7478AISD, ADCS7478AISDX
NS Package Number SDB06A

Notes

Notes

For more National Semiconductor product information and proven design tools, visit the following Web sites at:

Products		Design Support	
Amplifiers	www.national.com/amplifiers	WEBENCH® Tools	www.national.com/webench
Audio	www.national.com/audio	App Notes	www.national.com/appnotes
Clock and Timing	www.national.com/timing	Reference Designs	www.national.com/refdesigns
Data Converters	www.national.com/adc	Samples	www.national.com/samples
Interface	www.national.com/interface	Eval Boards	www.national.com/evalboards
LVDS	www.national.com/lvds	Packaging	www.national.com/packaging
Power Management	www.national.com/power	Green Compliance	www.national.com/quality/green
Switching Regulators	www.national.com/switchers	Distributors	www.national.com/contacts
LDOs	www.national.com/ldo	Quality and Reliability	www.national.com/quality
LED Lighting	www.national.com/led	Feedback/Support	www.national.com/feedback
Voltage Reference	www.national.com/vref	Design Made Easy	www.national.com/easy
PowerWise® Solutions	www.national.com/powerwise	Solutions	www.national.com/solutions
Serial Digital Interface (SDI)	www.national.com/sdi	Mil/Aero	www.national.com/milaero
Temperature Sensors	www.national.com/tempensors	SolarMagic™	www.national.com/solarmagic
Wireless (PLL/VCO)	www.national.com/wireless	PowerWise® Design University	www.national.com/training

THE CONTENTS OF THIS DOCUMENT ARE PROVIDED IN CONNECTION WITH NATIONAL SEMICONDUCTOR CORPORATION ("NATIONAL") PRODUCTS. NATIONAL MAKES NO REPRESENTATIONS OR WARRANTIES WITH RESPECT TO THE ACCURACY OR COMPLETENESS OF THE CONTENTS OF THIS PUBLICATION AND RESERVES THE RIGHT TO MAKE CHANGES TO SPECIFICATIONS AND PRODUCT DESCRIPTIONS AT ANY TIME WITHOUT NOTICE. NO LICENSE, WHETHER EXPRESS, IMPLIED, ARISING BY ESTOPPEL OR OTHERWISE, TO ANY INTELLECTUAL PROPERTY RIGHTS IS GRANTED BY THIS DOCUMENT.

TESTING AND OTHER QUALITY CONTROLS ARE USED TO THE EXTENT NATIONAL DEEMS NECESSARY TO SUPPORT NATIONAL'S PRODUCT WARRANTY. EXCEPT WHERE MANDATED BY GOVERNMENT REQUIREMENTS, TESTING OF ALL PARAMETERS OF EACH PRODUCT IS NOT NECESSARILY PERFORMED. NATIONAL ASSUMES NO LIABILITY FOR APPLICATIONS ASSISTANCE OR BUYER PRODUCT DESIGN. BUYERS ARE RESPONSIBLE FOR THEIR PRODUCTS AND APPLICATIONS USING NATIONAL COMPONENTS. PRIOR TO USING OR DISTRIBUTING ANY PRODUCTS THAT INCLUDE NATIONAL COMPONENTS, BUYERS SHOULD PROVIDE ADEQUATE DESIGN, TESTING AND OPERATING SAFEGUARDS.

EXCEPT AS PROVIDED IN NATIONAL'S TERMS AND CONDITIONS OF SALE FOR SUCH PRODUCTS, NATIONAL ASSUMES NO LIABILITY WHATSOEVER, AND NATIONAL DISCLAIMS ANY EXPRESS OR IMPLIED WARRANTY RELATING TO THE SALE AND/OR USE OF NATIONAL PRODUCTS INCLUDING LIABILITY OR WARRANTIES RELATING TO FITNESS FOR A PARTICULAR PURPOSE, MERCHANTABILITY, OR INFRINGEMENT OF ANY PATENT, COPYRIGHT OR OTHER INTELLECTUAL PROPERTY RIGHT.

LIFE SUPPORT POLICY

NATIONAL'S PRODUCTS ARE NOT AUTHORIZED FOR USE AS CRITICAL COMPONENTS IN LIFE SUPPORT DEVICES OR SYSTEMS WITHOUT THE EXPRESS PRIOR WRITTEN APPROVAL OF THE CHIEF EXECUTIVE OFFICER AND GENERAL COUNSEL OF NATIONAL SEMICONDUCTOR CORPORATION. As used herein:

Life support devices or systems are devices which (a) are intended for surgical implant into the body, or (b) support or sustain life and whose failure to perform when properly used in accordance with instructions for use provided in the labeling can be reasonably expected to result in a significant injury to the user. A critical component is any component in a life support device or system whose failure to perform can be reasonably expected to cause the failure of the life support device or system or to affect its safety or effectiveness.

National Semiconductor and the National Semiconductor logo are registered trademarks of National Semiconductor Corporation. All other brand or product names may be trademarks or registered trademarks of their respective holders.

Copyright© 2009 National Semiconductor Corporation

For the most current product information visit us at www.national.com



National Semiconductor Americas Technical Support Center
 Email: support@nsc.com
 Tel: 1-800-272-9959

National Semiconductor Europe Technical Support Center
 Email: europe.support@nsc.com

National Semiconductor Asia Pacific Technical Support Center
 Email: ap.support@nsc.com

National Semiconductor Japan Technical Support Center
 Email: jpn.feedback@nsc.com