

## Schottky Barrier Rectifiers

Using the Schottky Barrier principle with a Molybdenum barrier metal. These state-of-the-art geometry features epitaxial construction with oxide passivation and metal overlay contact. Ideally suited for low voltage, high frequency rectification, or as free wheeling and polarity protection diodes.

- \* Low Forward Voltag.
- \* Low Switching noise.
- \* High Current Capacity
- \* Guarantee Reverse Avalance.
- \* Guard-Ring for Stress Protection.
- \* Low Power Loss & High efficiency.
- \* 125 °C Operating Junction Temperature
- \* Low Stored Charge Majority Carrier Cnduction.
- \* Plastic Material used Carries Underwriters Laboratory Flammability Classification 94V-O

### SCHOTTKY BARRIER RECTIFIERS

**16 AMPERES  
30-60 VOLTS**

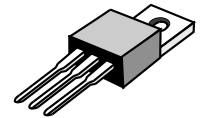

**TO-220AB**

### MAXIMUM RATINGS

Characteristic	Symbol	S16C						Unit
		30	35	40	45	50	60	
Peak Repetitive Reverse Voltage Working Peak Reverse Voltage DC Blocking Voltage	$V_{RRM}$ $V_{RWM}$ $V_R$	30	35	40	45	50	60	V
RMS Reverse Voltage	$V_{R(RMS)}$	21	24	28	32	35	42	V
Average Rectifier Forward Current Total Device (Rated $V_R$ , $T_C=100^\circ\text{C}$ )	$I_{F(AV)}$	8 16						A
Peak Repetitive Forward Current ( Rate $V_R$ , Square Wave, 20kHz )	$I_{FRM}$	16						A
Non-Repetitive Peak Surge Current ( Surge applied at rate load conditions halfware, single phase, 60Hz )	$I_{FSM}$	150						A
Operating and Storage Junction Temperature Range	$T_J, T_{stg}$	- 65 to + 125						°C

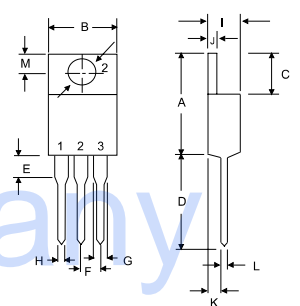

DIM	MILLIMETERS	
	MIN	MAX
A	14.68	15.32
B	9.78	10.42
C	6.01	6.52
D	13.06	14.62
E	3.57	4.07
F	2.42	2.66
G	1.12	1.36
H	0.72	0.96
I	4.22	4.98
J	1.14	1.36
K	2.20	2.97
L	0.33	0.55
M	2.48	2.98
O	3.70	3.90

### ELECTRICAL CHARACTERISTICS

Characteristic	Symbol	S16C						Unit
		30	35	40	45	50	60	
Maximum Instantaneous Forward Voltage ( $I_F=8.0$ Amp, $T_C = 25^\circ\text{C}$ ) ( $I_F=8.0$ Amp, $T_C = 100^\circ\text{C}$ )	$V_F$	0.55 0.48			0.70 0.57			V
Maximum Instantaneous Reverse Current ( Rated DC Voltage, $T_C = 25^\circ\text{C}$ ) ( Rated DC Voltage, $T_C = 125^\circ\text{C}$ )	$I_R$	1.0 40						mA

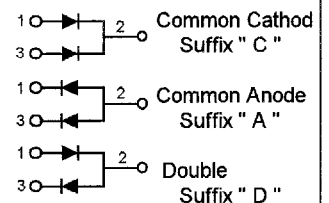

# S16C30 thru S16C45

FIG-1 FORWARD CURRENT DERATING CURVE

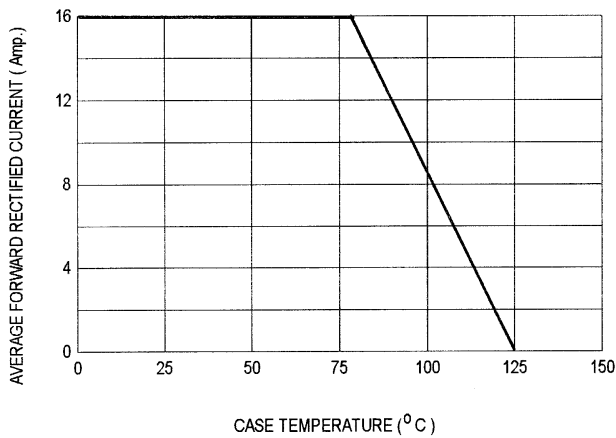

FIG-2 TYPICAL FORWARD CHARACTERISTICS

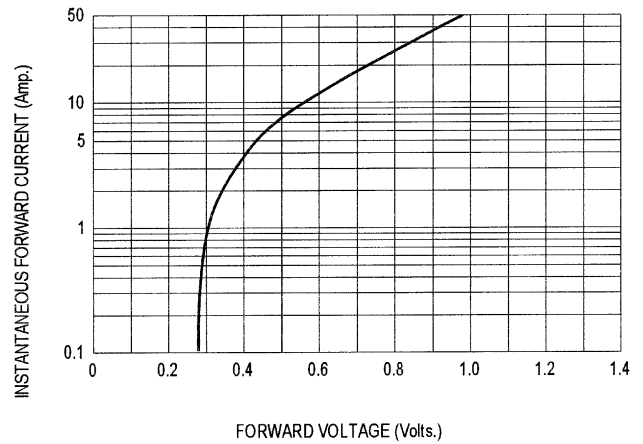

FIG-3 TYPICAL REVERSE CHARACTERISTICS

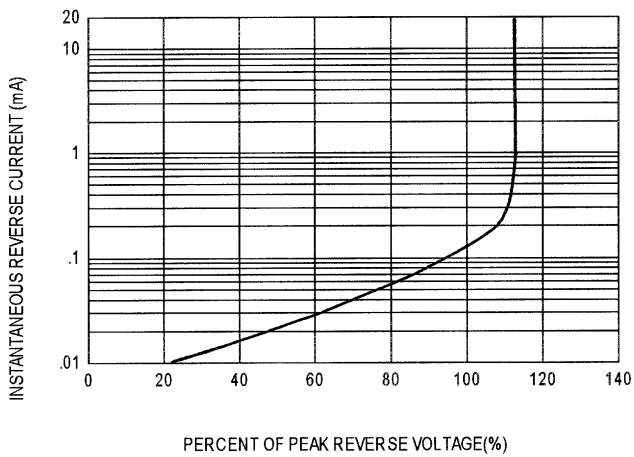

FIG-4 TYPICAL JUNCTION CAPACITANCE

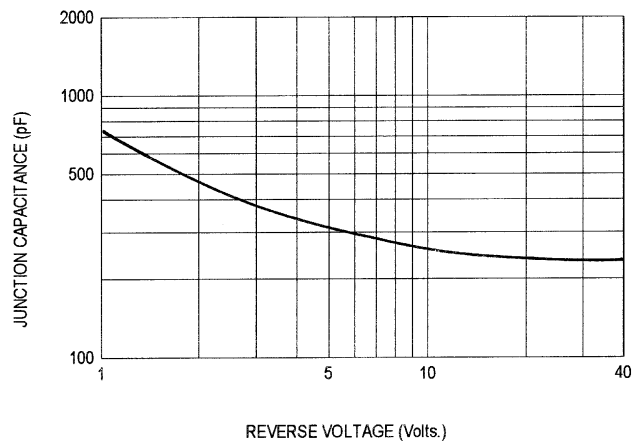
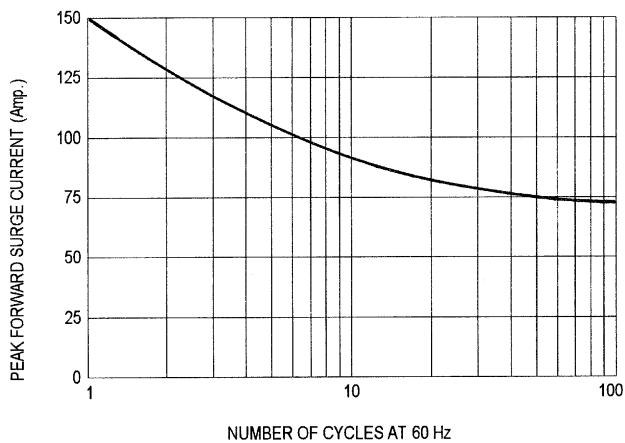

FIG-5 PEAK FORWARD SURGE CURRENT



# S16C50 , S16C60

FIG-1 FORWARD CURRENT DERATING CURVE

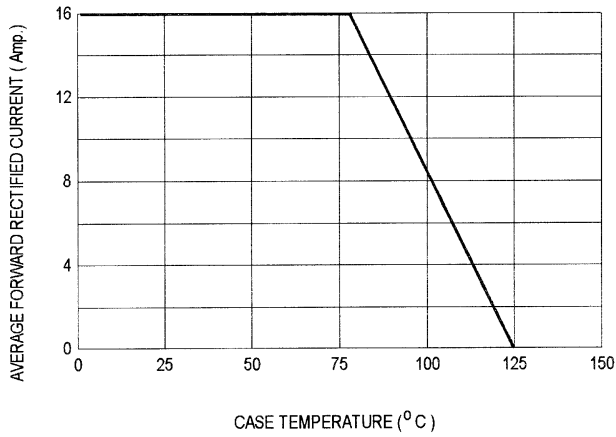

FIG-2 TYPICAL FORWARD CHARACTERISTICS

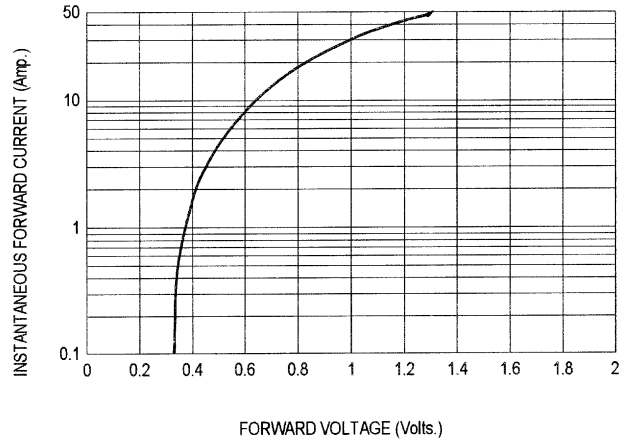

FIG-3 TYPICAL REVERSE CHARACTERISTICS

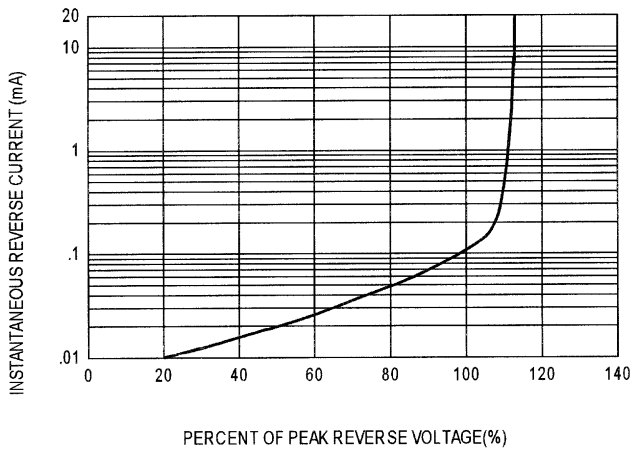

FIG-4 TYPICAL JUNCTION CAPACITANCE

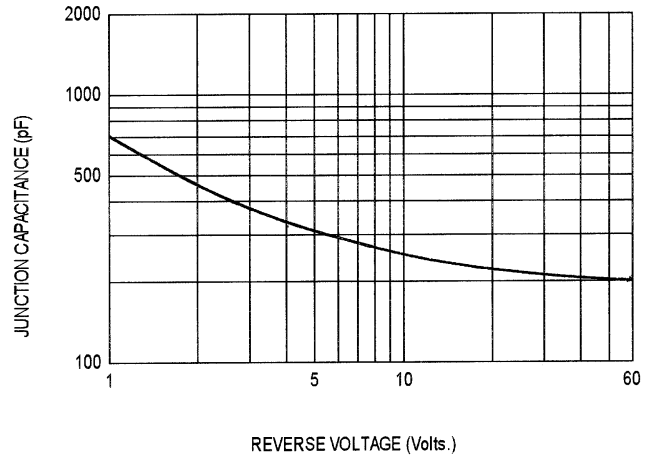

FIG-5 PEAK FORWARD SURGE CURRENT

